

ULTIMEA



Ultimea Skywave X100

User Manual



Latest Manual

1. IMPORTANT SAFETY INSTRUCTIONS

- Please read and keep these instructions. Follow all warnings and operate according to the instructions.
- Do not use the device near water, in damp environments, or in the rain. Avoid spilling liquids on the device or placing objects containing liquids (such as vases) on top of it.
- Clean only with a dry cloth. Do not use liquid cleaners.
- Do not block ventilation openings or install the device in a confined space. Ensure proper ventilation and install the device according to the manufacturer's instructions.
- Do not install the device near heat sources such as radiators, stoves, amplifiers, or other devices that produce heat. Do not cover the ventilation openings with items like newspapers or curtains.
- Only use attachments, stands, or accessories specified by the manufacturer. When using equipment with wheels, exercise caution when moving to prevent tipping.
- Protect the power cord from being walked on, pinched, or bent, especially at plugs, convenience receptacles, and the point where they exit from the device.
- Do not modify the plug's polarization or grounding features. If the plug does not fit into the outlet, consult an electrician to replace the outlet.
- Unplug the power cord during lightning storms or when not in use for long periods. To completely disconnect the device from the power supply, unplug it from the wall outlet and ensure the plug is easily accessible.
- Do not place any open flame sources, such as lit candles, on the device.
- Do not attempt to open the device. High voltage inside may cause electric shock or death. There are no user-serviceable parts inside. All servicing must be performed by qualified personnel.
- The installation height of the device must not exceed 2 meters.

2. ACCESSORIES LIST

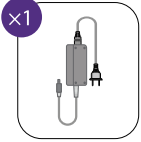
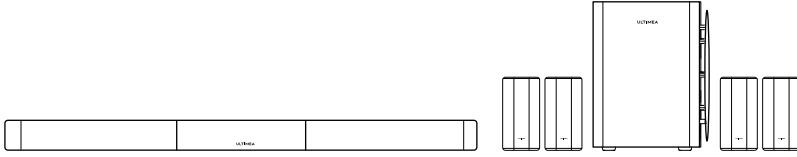

Soundbar Power Adapter(3m / 118")

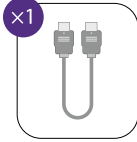

HDMI Cable (1.5m / 59")

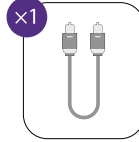

Digital Optical Cable(1.5m / 59")

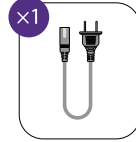

Subwoofer Power Cord(2m / 78")



Surround Power Adapter(3m / 118")



Remote Control

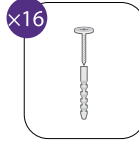

Wall Mount Screws & Anchors

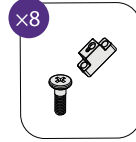

Mount Brackets & Screws

3. SOUNDBAR CONTROLS

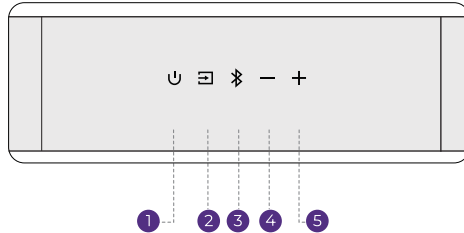

Control Panel

- 1 "⏻": Power Button**
Press to power on or enter standby mode.
- 2 "☰": Source**
Press to switch input source: eARC - HDMI IN - OPT (OPTICAL) - Bluetooth® - USB.
- 3 "📶": Bluetooth®**
Press to switch to Bluetooth® mode. The soundbar will automatically enter pairing mode. Press and hold for 3 seconds to disconnect the current device and manually pair a new device from your smartphone, PC, or TV.
- 4 "—": Volume Down**
- 5 "+": Volume Up**

4. REMOTE CONTROL

- “U” : Power Button**
Press to power on / standby
- “☐” : SOURCE**
Press to switch channels
- “Bluetooth®”**
Press to switch to Bluetooth® channel
- “+” : Volume Up**
- “-” : Volume Down**
- “<” : Previous**
For Bluetooth® and USB mode only Skip to previous track
- “>” : Next**
For Bluetooth® and USB mode only Skip to next track
- “▶||” : Play / Pause**
For Bluetooth® and USB mode only
- “EQ Mode”**
Press to switch EQ mode
Standard, Cinema, Music, Voice, Game, Night
- “Xupmix”**
The default setting is “on”, allowing for unified control over the activation and deactivation of 6 sound effect modes.
Xupmix on: The surround channel sound will be provided by a rich multi-channel signal processed by the algorithm, offering a more immersive auditory experience.
Xupmix off: The surround channel sound will be optimized based on the left and right channel signals using an algorithm, resulting in a broader sound field effect.
- BASS**
Press to adjust bass level
- “Up-Firing Level”**
Press to adjust the height channel volume
- “Surround Level”**
Press to adjust surround sound level
- “MUTE”**
Press to mute
Press and hold the MUTE button for 5 seconds to restore factory settings

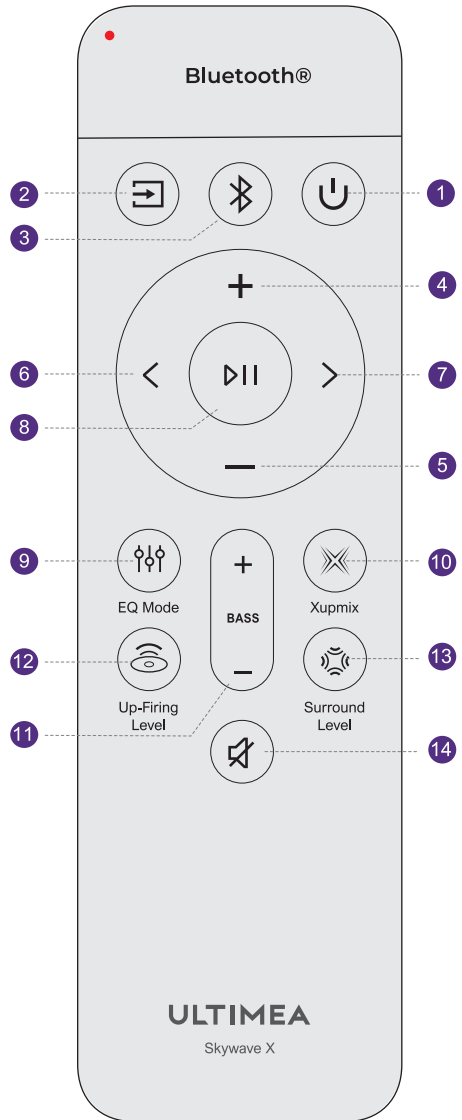

Note: The remote backlight timeout can be adjusted by pressing and holding “<” and “>” for 3 seconds. Shorter timeout settings help extend battery life.

5. SOUNDBAR INSTALLATION

Align the joints of the three sections and twist them together until securely connected.

Caution: Make sure the soundbar is powered off during assembly.

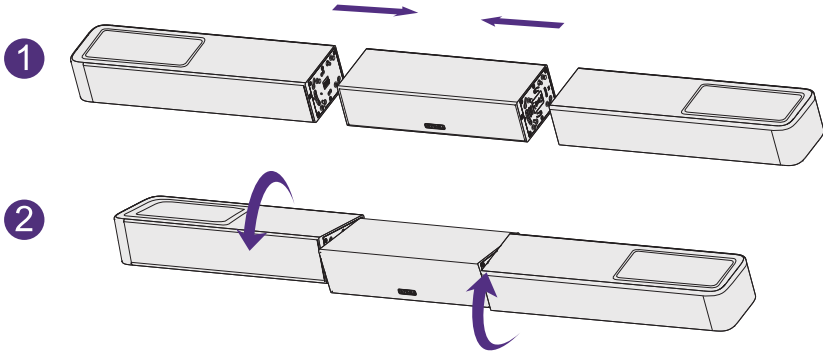

6. REAR PANEL

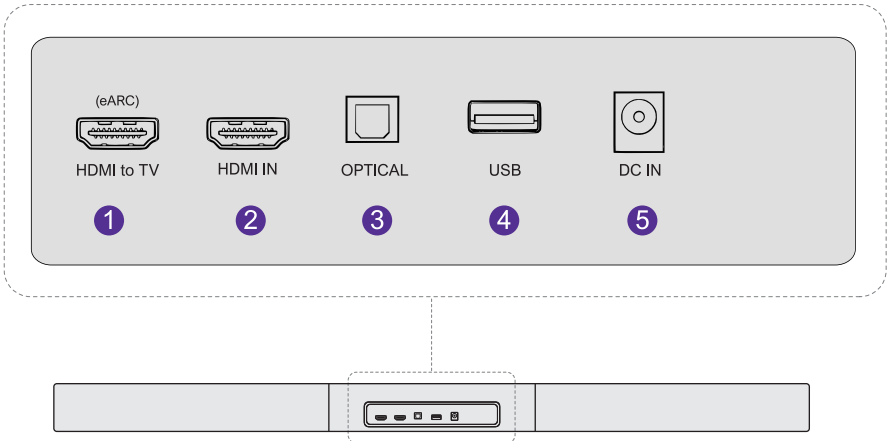

Note: **USB** Supports MP3 or FLAC files.

7. SYSTEM PLACEMENT

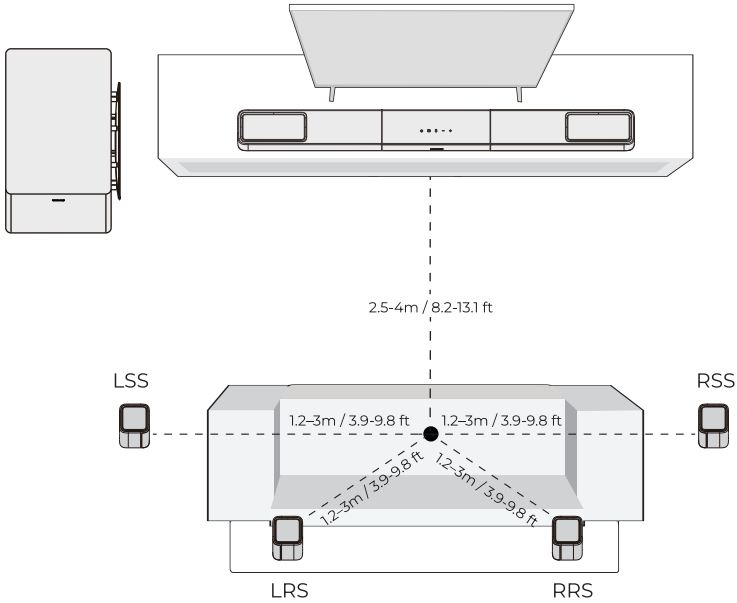

8. WALL MOUNT INSTALLATION

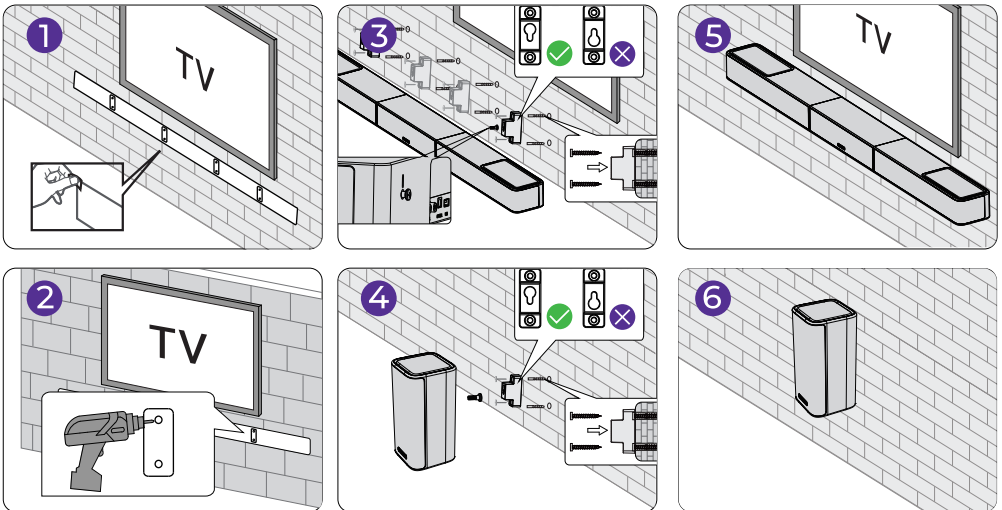

Note: The wall mount bracket used for the surround speakers is identical to that of the soundbar. The vertical hole spacing is the same as the soundbar. Please refer to the Wall-Mounting Guide for details.

9. CONNECT AND POWER ON

- 1 Plug the soundbar power adapter into a wall outlet.

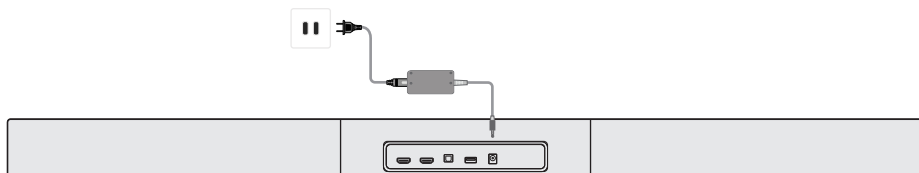

- 2 Plug the subwoofer power cable into a wall outlet.

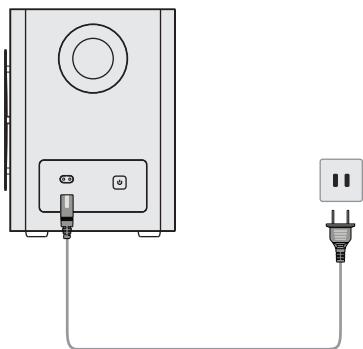

- 3 Plug each surround speaker power adapter into a wall outlet.

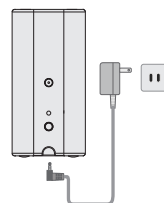

- 4 Note: It is recommended to use disposable alkaline batteries. Rechargeable batteries are not recommended.

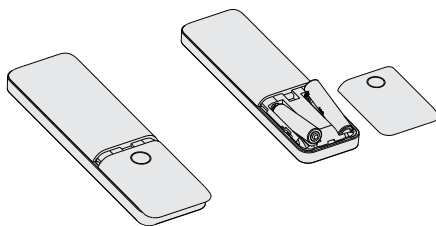

Batteries Not Included.

10. CONNECT TO TV VIA HDMI eARC

- 1 Connect one end of the HDMI cable to the eARC/ARC port on the back of your TV.

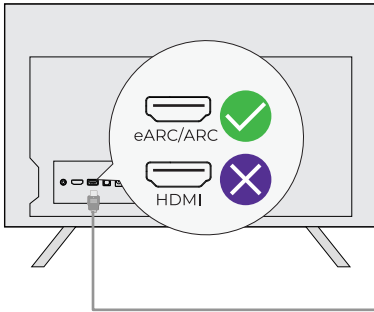

- 2 Connect the other end to the eARC port on the soundbar.

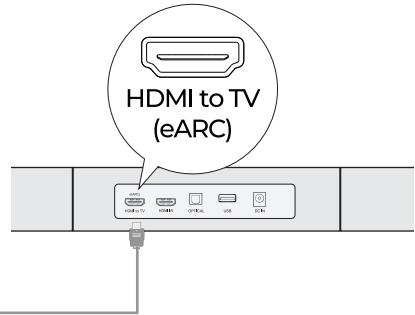

- 3 Press the "Source" button on the soundbar or remote control to select the "eARC" input.

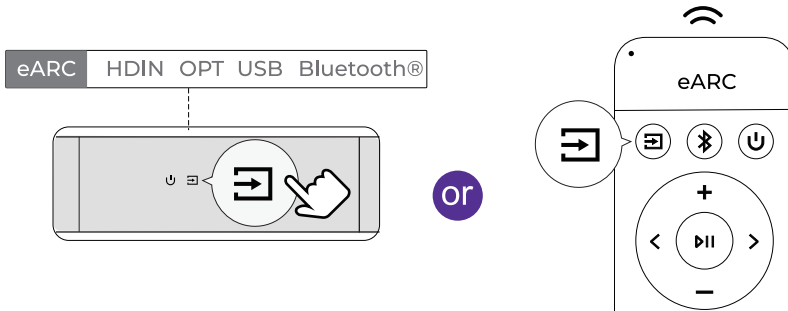

Note: Make sure your TV HDMI port supports eARC; otherwise, the Dolby Atmos audio signal cannot be transmitted.

Dolby Atmos: If you are watching content in Dolby Atmos format, set the audio output on your TV to Pass Through.
TV Settings > Home > Settings > Sound > Digital Audio Output > Pass Through

What's the difference between HDMI IN, HDMI ARC, and HDMI eARC?

HDMI IN is a standard HDMI input used to connect external devices. It supports audio and video signals but does not support ARC or eARC.

HDMI ARC supports two-way audio transmission between your TV and audio system through a single HDMI cable.

HDMI eARC (Enhanced Audio Return Channel) is an upgraded version of ARC that supports higher-quality audio formats such as Dolby Atmos.

Note: Enable the "CEC" function on your TV. When eARC or ARC is connected, your TV remote can control both the soundbar and TV simultaneously:

- (1) Power On / Standby
- (2) Adjust Volume

11. CONNECT TO TV VIA OPTICAL CABLE

- 1 Make sure the TV's port is OPTICAL OUT. Connect both ends of the optical cable to the OPTICAL ports on the TV and the soundbar.

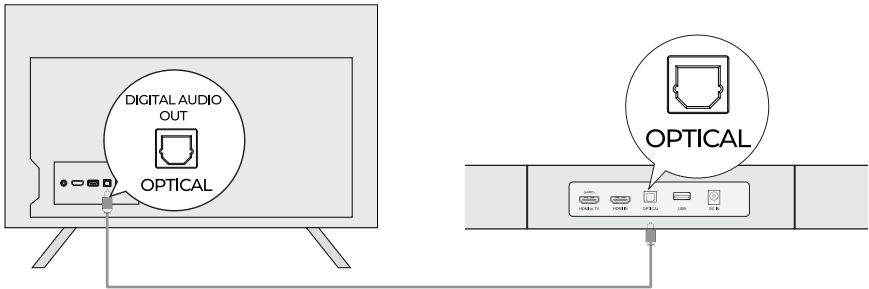

- 2 Make sure the optical plug is inserted correctly as shown in the picture. Do not insert it upside down, as this may damage the optical port.
- 3 TV Settings > Home > Settings > Sound > Digital Audio Output > PCM

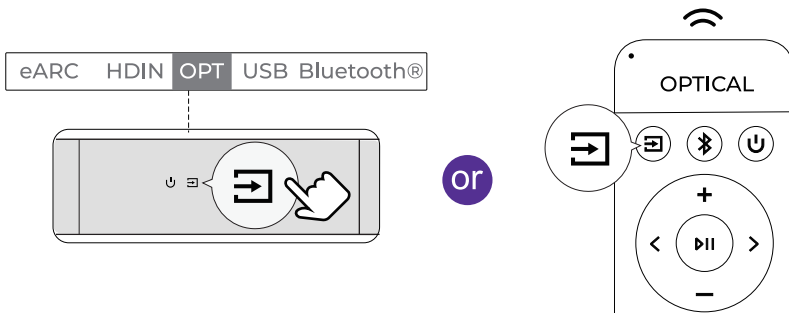

Note: If audio is playing from the TV's internal speakers, mute the TV or turn the volume down to the minimum.

The optical port does not support Dolby Atmos. It only supports Dolby Digital Plus (7.1). For the best Dolby Atmos experience, use HDMI IN or HDMI eARC.

12. CONNECT EXTERNAL DEVICES

- 1 Connect the HDMI cable to the HDMI eARC/ARC port on your TV.

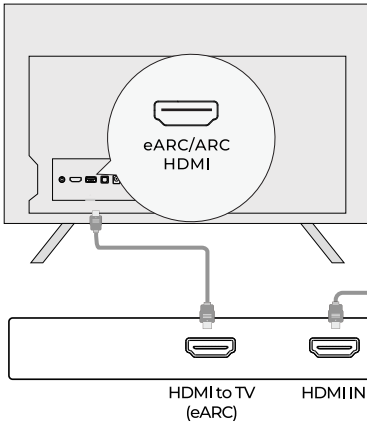

- 2 Connect the external device HDMI OUT to the soundbar HDMI IN.

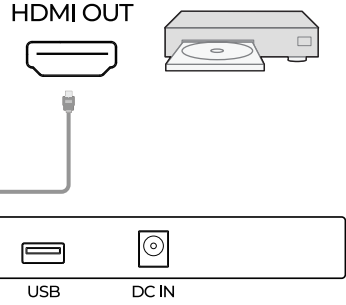

- 3 Press the "Source" button on the soundbar or remote control to select the "HDIN" input.

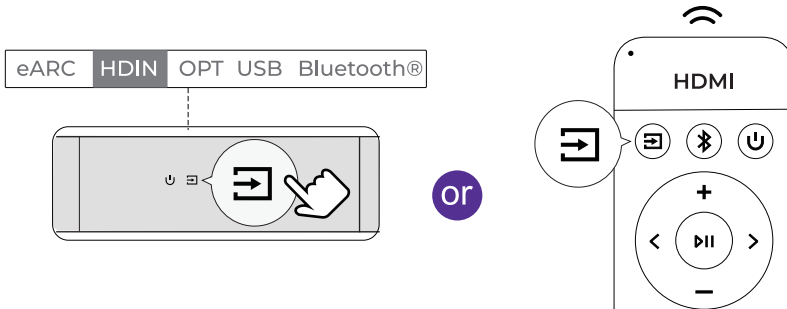

Connecting External Devices: TV Box, DVD Player, Game Console, etc.

Example: DVD Connection

Step 1: Connect the HDMI cable from the HDMI OUT port on the DVD player (or other external device) to the HDMI IN port on the Soundbar.

Step 2: Connect another HDMI cable from the HDMI OUT (eARC) port on the Soundbar to the HDMI eARC/ARC port on the TV.

Note: Your TV's HDMI port must support eARC to transmit Dolby Atmos audio to the Soundbar.

Step 3: Press the "Source" button on the Soundbar or remote control to switch to the HDMI IN channel.

Step 4: Set the DVD player's audio output format to "Bitstream" or "Auto".

Alternative Connection for External Devices

Example: Chromecast / Fire TV Stick

- Plug the Chromecast or Fire TV Stick into one of the HDMI IN ports on your TV.
- Use an HDMI cable to connect your TV's HDMI eARC/ARC port to the Soundbar's HDMI OUT (eARC) port.
- Set your TV's audio output to "External Speakers" or "HDMI (ARC/eARC)".
- Select "TV/eARC" as the input source on the Soundbar.
- On your TV, switch the input/source to the HDMI port where the Chromecast or Fire TV Stick is connected.

13. CONNECT TO Bluetooth®

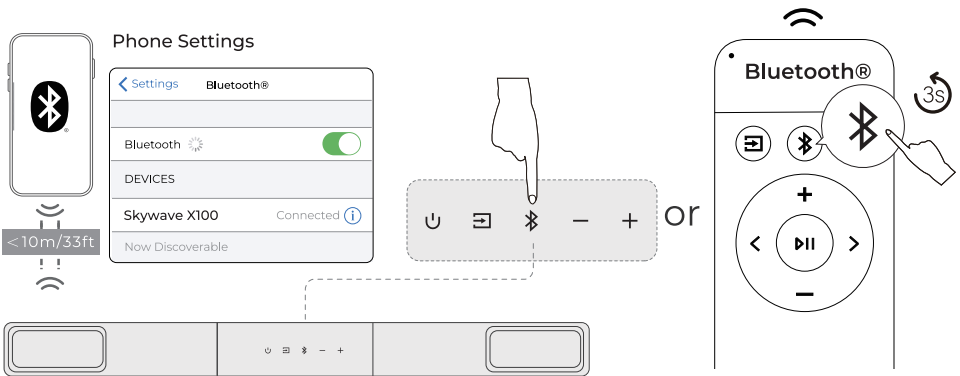

- 1 Press the "Bluetooth®" button on the soundbar or press the "Bluetooth®" button on the remote control to enter Bluetooth® pairing mode
- 2 Go to the Bluetooth® settings on your phone, find and select "Skywave X100" to connect the soundbar
- 3 Note: If it's already in Bluetooth® mode and connected, press and hold the "Bluetooth®" button for 3 seconds to disconnect the current device and then manually choose to connect to a new device on your mobile phone / PC / TV

14. Auracast™ RECEIVE MODE

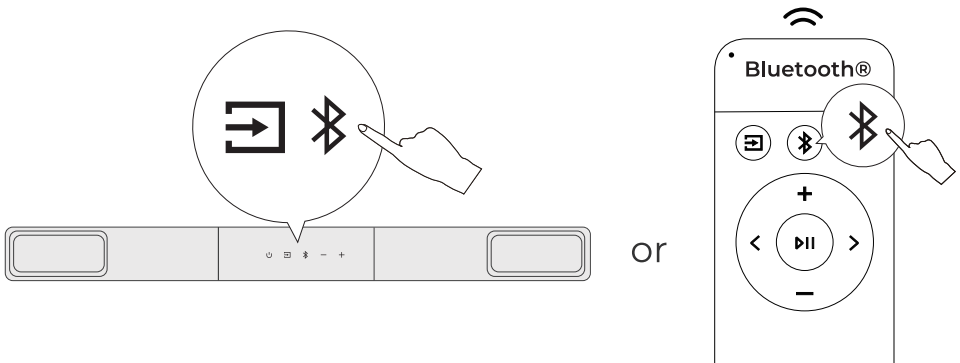

Press the Source and Bluetooth® buttons on the main unit simultaneously, or double-click the Bluetooth® button on the remote to enter Auracast™ Receive Mode and join an available broadcast.

Repeat the action (or press Source) to stop broadcast playback.

15. RE-PAIR SUBWOOFER

Normally, the Soundbar and subwoofer are pre-paired. If the connection is lost, please follow the steps below to re-pair them:

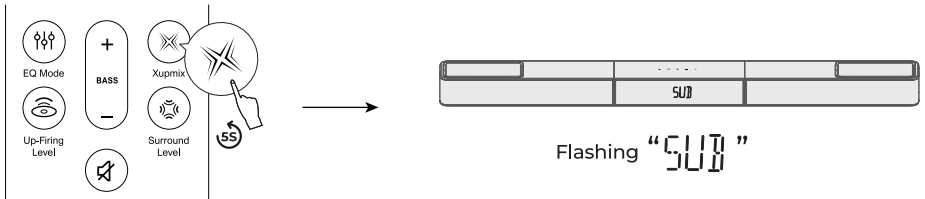

- 1 Press and hold the "Xupmix" button on the remote control for 5 seconds. The main unit display will flash "SUB" to indicate pairing mode

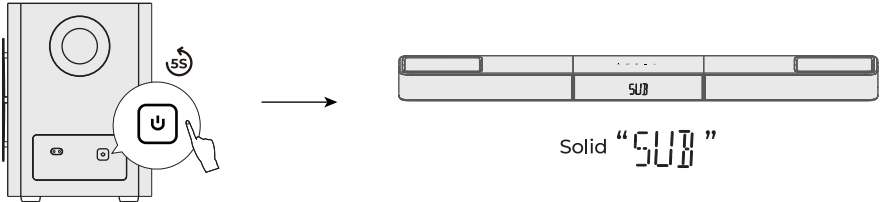

- 2 Press and hold the pairing button on the back of the subwoofer for 5 seconds to enter pairing mode
- 3 When pairing is successful, the main unit display will stop flashing and the subwoofer indicator light will remain steadily on

16. RE-PAIR SURROUND

Normally, the Soundbar and Surround are pre-paired. If the connection is lost, please follow the steps below to re-pair them:

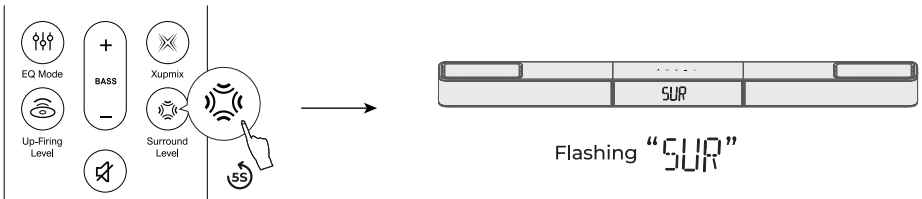

- 1 Press and hold the "Surround Level" button on the remote control for 5 seconds. The main unit display will flash "SUR" to indicate pairing mode

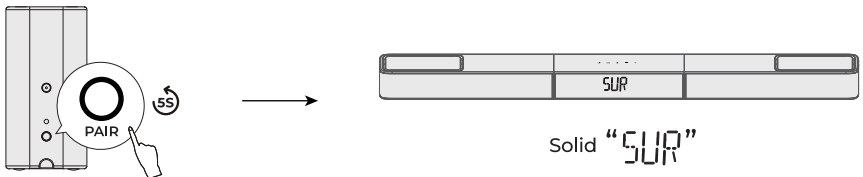

- 2 Press and hold the pairing button on the back of the Surround for 5 seconds to enter pairing mode
- 3 When pairing is successful, the main unit display will stop flashing and the Surround indicator light will remain steadily on

17. REMOTE RECONNECTION

The soundbar and remote control are usually paired at the factory. If the connection is lost, please follow the steps below to re-pair:

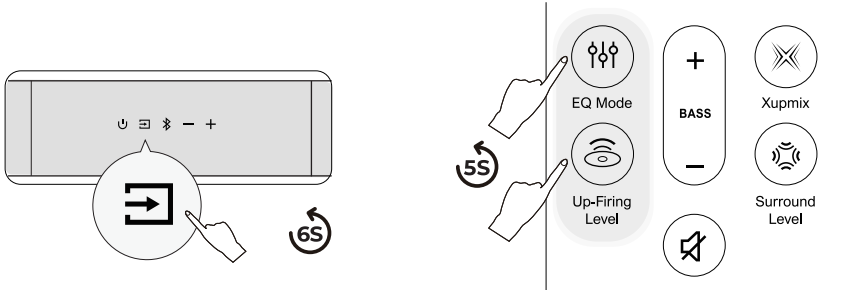

- 1 Switch the soundbar to Bluetooth® mode and press and hold the Source button for about 6 seconds
- 2 At the same time, press and hold the "EQ Mode" and "Up-Firing Level" buttons on the remote for about 5 seconds to enter remote pairing mode

18. RESTORE FACTORY SETTINGS

Press and hold the MUTE button for 5 seconds to restore factory settings

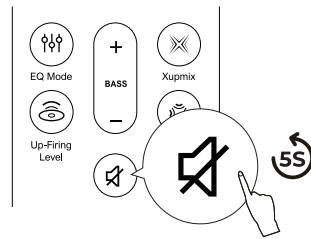

19. ADJUST PROMPT SOUND VOLUME

If you find the Soundbar's prompt tone too loud, you can adjust its volume through the ULTIMEA App.



Download Ultimea App

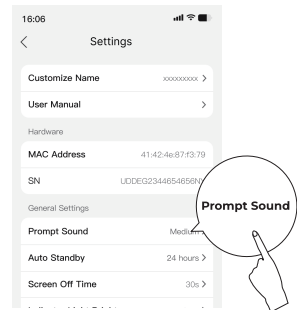
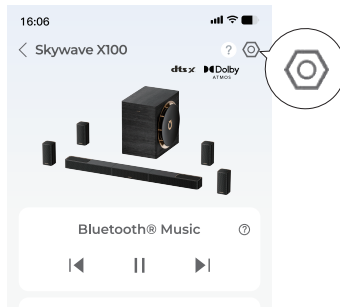

- 1 Scan the QR code to download the ULTIMEA App, then add your Soundbar to the app.
- 2 Open the Soundbar's Device Details page, tap the Settings icon in the upper-right corner, and select "Prompt Sound Volume". Adjust the level as needed.

Model Number	U622B
Power Supply	DC 18V 5A(Soundbar) / DC 18V 1.5A(Surround)/ AC 110~220V(Subwoofer)
Soundbar Drivers	Soundbar:2.25" x6 + 2.25" x 2 , Surround: 2.25" x 4 + 2.25" x4, Subwoofer: 10" x1
Auto Standby	The soundbar will turn to standby mode if there is no audio signal for 15 minutes. You can set the standby time in the App
Standby Power	<0.5W
Operating Temperature	-10 C -45 C / 14 °F-113°F
Bluetooth® Version	6.0

Soundbar	1102 x 100 x 70 mm / 43.39" × 3.94" × 2.76"
Subwoofer	260 x 355 x 355 mm / 10.2" × 14.0" × 14.0"
Surround Speaker	85 x85 x 170 mm / 3.35"× 3.35" × 6.69"
Packaging	550 × 550 × 650 mm / 21.6" × 21.6" × 25.6"
Net Weight	21.8kg / 48. lbs
Gross Weight	27.5kg / 60.6 lbs

USB Output	5V 500mA
Operating Altitude	2000 meters above sea level
Wall Mount Screw	4 x 35 mm / 0.16" x 1.4"
Bracket Screws Diameter	M5*10mm / 0.2" x 0.4"
Remote Control Battery Type	2 x AAA (NOT INCLUDED)
Notice: Risk of fire or explosion if the battery is replaced by an incorrect type.	

PROPER DISPOSAL INSTRUCTIONS



This mark shown on the product or its packaging, indicates that this product should not be disposed of with other household waste at the end of its working life. To prevent possible harm to the environment or human health from uncontrolled waste disposal, please separate this from other types of wastes and recycle it responsibly to promote the sustainable reuse of material resources.

WASTE ELECTRICAL & ELECTRONIC EQUIPMENT

Household user should contact either the retailer where they purchased this product, or their local government office, for details of where and how they can take this item for environmentally safe recycling. Business users should contact their suppliers and check the terms and conditions of the purchase contract. This product should not be mixed with other commercial wastes for disposal.

WIRELESS FREQUENCY RANGE AND WIRELESS OUTPUT POWER:

Frequency: 2.402GHz-2.48GHz,5.8GHz
 Soundbar Bluetooth® Max.transmit power:10dBm
 Soundbar wireless Max.transmit power: 10dBm
 Surround wireless Max.transmit power: 10dBm

FCC REGULATORY COMPLIANCE

Any changes or modifications not expressly approved by the party responsible for compliance could void the user's authority to operate the equipment.

This device complies with Part 15 of the FCC Rules.

Operation is subject to the following two conditions:

(1) This device may not cause harmful interference.

(2) This device must accept any interference received, including interference that may cause undesired operation.

NOTE: This equipment has been tested and found to comply with the limits for a Class B digital device, pursuant to part 15 of the FCC Rules. These limits are designed to provide reasonable protection against harmful interference in a residential installation. This equipment generates, uses, and can radiate radio frequency energy, and if not installed and used in accordance with the instructions, may cause harmful interference to radio communications.

However, there is no guarantee that interference will not occur in a particular installation. If this equipment does cause harmful interference to radio or television reception, which can be determined by turning the equipment off and on, the user is encouraged to try to correct the interference by one or more of the following measures:

- Reorient or relocate the receiving antenna.

- Increase the separation between the equipment and the receiver.

- Connect the equipment to an outlet on a circuit different from that to which the receiver is connected.

- Consult the dealer or an experienced radio / TV technician for help.

This equipment complies with FCC radiation exposure limits set forth for an uncontrolled environment. This equipment should be installed and operated with a minimum distance of 20cm between the radiator & your body. This transmitter must not be co-located or operating in conjunction with any other antenna or transmitter.

CE WARNINGS

(1) Do not install this equipment in a confined or building-in space such as a book case or similar unit, and remain a well ventilation conditions. The ventilation should not be impeded by covering the ventilation openings with items such as newspaper, table-cloths, curtains etc.

(2) WARNING: To reduce the risk of fire or electric shock, do not expose this apparatus to rain or moisture. The apparatus shall not be exposed to dripping or splashing and that objects filled with liquids, such as vases, shall not be placed on apparatus.

(3) WARNING: The adapter plug is used as disconnect device, the disconnect device shall remain readily operable.

(4) Frequency: 2.402GHz-2.48GHz

(5) The Max. transmit power: 10 dBm

▲ WARNING: This product can expose you to chemicals including lead, which is known to the State of California to cause cancer and birth defects or other reproductive harm. For more information, go to www.P65Warnings.ca.gov.

Trade Marks:



Dolby, Dolby Atmos, and the double-D symbol are registered trademarks of Dolby Laboratories Licensing Corporation. Manufactured under license from Dolby Laboratories. Confidential unpublished works. Copyright © 2012–2024 Dolby Laboratories. All rights reserved.



Manufactured under license from DTS, Inc. and/or its affiliates. For patents, see <https://xperi.com/dts-patents/>. DTS, the DTS logo, DTS:X, the DTS:X logo, Virtual:X, and the DTS Virtual:X logo are trademarks or registered trademarks of DTS, Inc. and/or its affiliates in the U.S. and/or other countries. © DTS, Inc. and/or its affiliates. All rights reserved.



The Bluetooth® word mark and logos are registered trademarks owned by Bluetooth SIG, Inc. The Auracast™ word mark and logos are trademarks owned by the Bluetooth SIG. Any use of such marks by Ultimea Technology (Shenzhen) Limited is under license. Other trademarks and trade names are those of their respective owners.



The terms HDMI, HDMI High-Definition Multimedia Interface, HDMI trade dress and the HDMI Logos are trademarks or registered trademarks of HDMI Licensing Administrator, Inc.



THX and the THX Logo are the property of THX Ltd., registered in the U.S. and other countries. Tuned by THX is a trademark belonging to THX Ltd.

ULTIMEA

Product Name: Soundbar
Model No.: U622B

EC REP Ultimea GmbH
Buchenring 57, 22359 Hamburg, Germany

UK REP EVATOST CONSULTING LTD
Office 101 32 Threadneedle Street, London, United Kingdom, EC2R 8AY

@Ultimea Inc. All rights reserved, registered in the United States and other countries. 801 S. Dupont Ave., Ste G, Ontario, CA, 91761, USA

Made in China
Manufacturer: Ultimea Technology (Shenzhen) Limited
Address: 20th Floor, Building 4, Tianan Cloud Park, Bantian St., Longgang District, Shenzhen, China 518000

Manufacturer Contact Information:

☎ +1 888-598-8875 (US) Mon-Fri 9am-5pm (PST) ☎ +49 89-628-25828 (EU) Mon-Fri 9am-5pm (CET) ✉ support@ultimea.com 🌐 support.ultimea.com

If you need our support, kindly reach out to our service team. We are always glad to help.



Warranty Extension Plan

EU DECLARATION OF CONFORMITY

We (Manufacturer) is responsible for this declaration)
20th Floor, Building 4, Tianan Cloud Park, Bantian St.,
Declare under our sole responsibility that the product
Trade Mark: ULTIMEA
Product Name: Soundbar
Model No.: U622B

Ultimea Technology (Shenzhen) Limited
Longgang District Shenzhen, China 518000

The product to which this declaration relates is in conformity with the essential requirements set out in the Council Directive on the Approximation of the laws of the Member States relating to the Radio Equipment Directive (2014/53/EU), the Restriction of Hazardous Substances Directive (2011/65/EU), the Electromagnetic Compatibility Directive (2014/30/EU), and the Low Voltage Directive (2014/35/EU). The product is responsible for affixing the CE marking, and the following standards were applied:

EN 55032:2015/A1:2020
EN 55035:2017/A1:2020
EN IEC 61000-3-2:2019/A2:2024
EN 61000-3-3:2013/A2:2021

ETSI EN 301 489-1 V2.2.3 (2019-11)
ETSI EN 301 489-17 V3.2.4 (2020-09)
ETSI EN 300 328 V2.2.2 (2019-07)
EN IEC 62311:2020
EN IEC 62368-1:2020+A11:2020

Full Name: Yoyo.Yu
Position: Approbation Manager
Signature: 
Place/Date: Shenzhen, China / March 10, 2026