

ULTIMEA



Ultimea Skywave X100 Dual

用户手册



最新说明书

1. 重要安全说明

- 请阅读并妥善保存本说明。请遵循所有警告提示，并按照说明进行操作。
- 请勿在靠近水源、潮湿环境或雨中使用本设备。避免将液体洒在设备上，或在设备上放置盛有液体的物品（如花瓶）。
- 仅可使用干布清洁。请勿使用液体清洁剂。
- 请勿堵塞通风口，也不要将设备安装在密闭空间内。请确保良好通风，并按照制造商的说明进行安装。
- 请勿将设备安装在散热器、炉具、功放或其他产生热量的设备附近。请勿用报纸、窗帘等物品覆盖通风口。
- 仅使用制造商指定的附件、支架或配件。使用带滚轮的设备时，移动过程中请小心，防止倾倒。
- 请保护电源线，避免被踩踏、夹压或弯折，尤其是在插头、插座以及电源线从设备引出处。
- 请勿改动插头的极性 or 接地结构。如插头无法插入插座，请联系专业电工更换插座。
- 雷雨天气或长时间不使用时，请拔下电源插头。
- 请勿在设备上放置任何明火源，如点燃的蜡烛。
- 请勿尝试拆开设备。内部存在高压电，可能导致触电或死亡。所有维修必须由专业人员进行。
- 设备的安装高度不得超过2米。

2. 配件清单

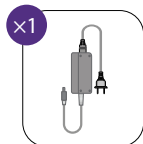
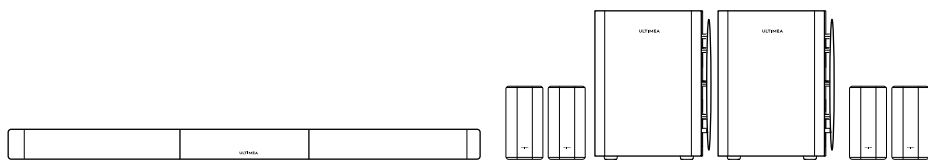

音箱电源适配器
(3 m / 118")

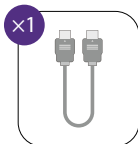

HDMI线
(1.5 m / 59")

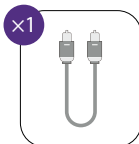

数字光纤线
(1.5 m / 59")

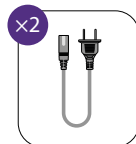

低音炮电源线
(2 m / 78")

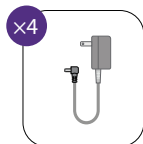

环绕电源适配器
(3 m / 118")

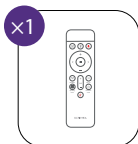

遥控器

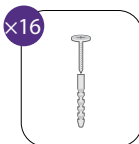

壁挂螺丝
及膨胀管

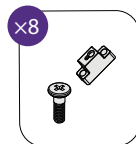

安装支架及
螺丝

3. Soundbar 控制说明

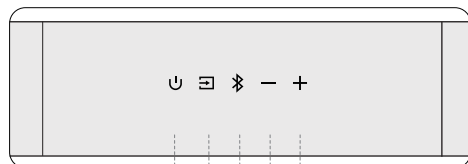

控制面板



- 1 “**⏻**”：电源键
按下开机或进入待机模式。
- 2 “**📺**”：信号源
按下切换输入源：eARC - HDMI IN - OPT (OPTICAL) - Bluetooth® - USB。
- 3 “**📶**”：Bluetooth®
按下切换至Bluetooth®模式，Soundbar 将自动进入配对状态。长按 3 秒断开当前设备，并通过手机、电脑或电视手动配对新设备。
- 4 “**—**”：音量减
- 5 “**+**”：音量加

4. 遥控器

- 1 “**U**”: 电源键
按下开机 / 待机
- 2 “**⇐**”: SOURCE
按下切换输入源
- 3 “**Bluetooth**”: Bluetooth®
按下切换至Bluetooth®模式
- 4 “**+**”: 音量增加
- 5 “**-**”: 音量降低
- 6 “**<**”: 上一曲
仅在Bluetooth®和USB模式下使用
切换至上一曲
- 7 “**>**”: 下一曲
仅在Bluetooth®和USB模式下使用
切换至下一曲
- 8 “**▶||**”: 播放 / 暂停
仅在Bluetooth®和USB模式下使用
- 9 “**EQ**”: EQ模式
按下切换EQ模式
标准、影院、音乐、人声、游戏、夜间
- 10 “**Xupmix**”
默认设置为“开启”，可统一控制6种音效模式的启用与关闭
Xupmix 开启 环绕声道通过算法处理为多声道信号，带来更沉浸的听觉体验
Xupmix 关闭 环绕声道基于左右声道信号进行优化，呈现更宽广的声场效果
- 11 BASS
按下调节低音等级
- 12 “**Up-Firing Level**”
按下调节天空声音量
- 13 “**Surround Level**”
按下调节环绕声等级
- 14 “**MUTE**”
按下静音
长按5秒恢复出厂设置

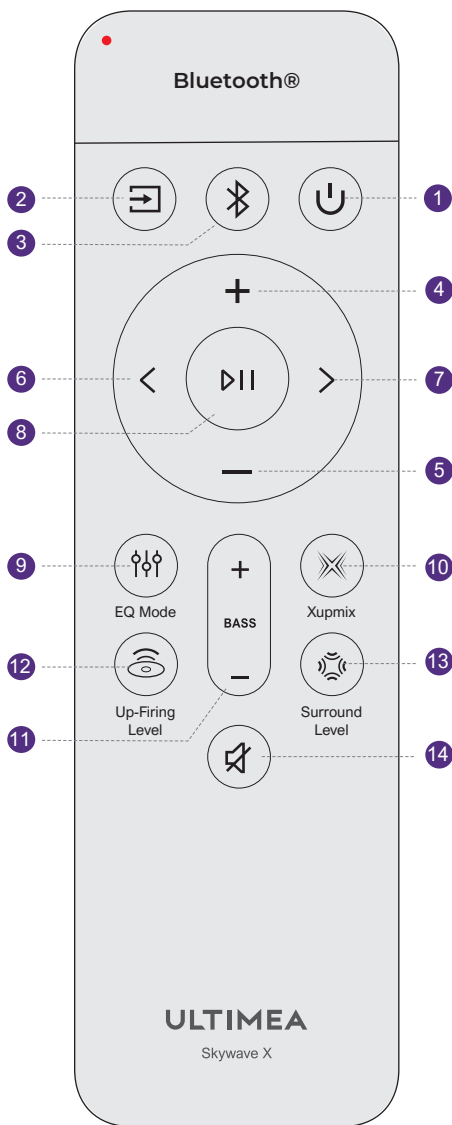

注意：同时长按“<”和“>”3秒可调节遥控器背光熄灭时间。
设置更短的熄灭时间有助于延长电池寿命。

5. Soundbar 安装

将三段接口对齐后旋转拧紧，直至牢固连接。

注意：组装过程中请确保 Soundbar 处于断电状态。

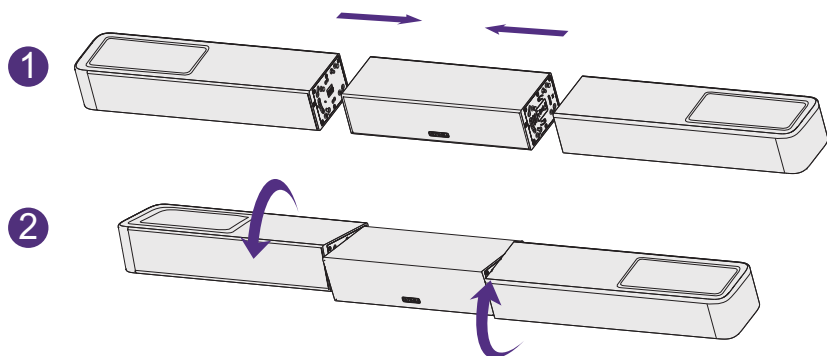

6. 后面板

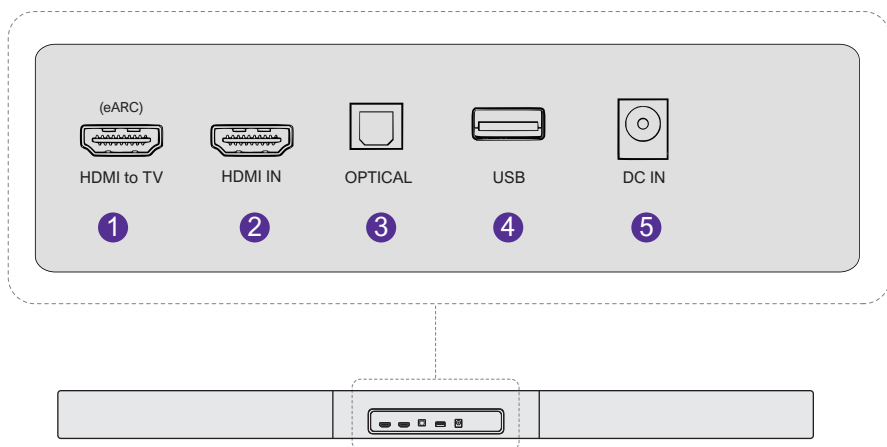

注意：USB 支持 MP3 或 FLAC 文件。

7. 系统摆放

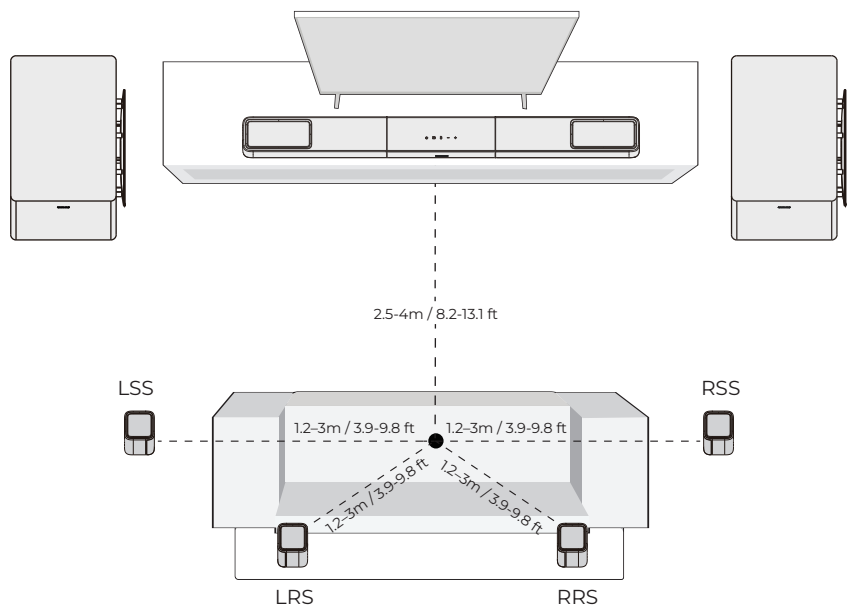

8. 壁挂安装

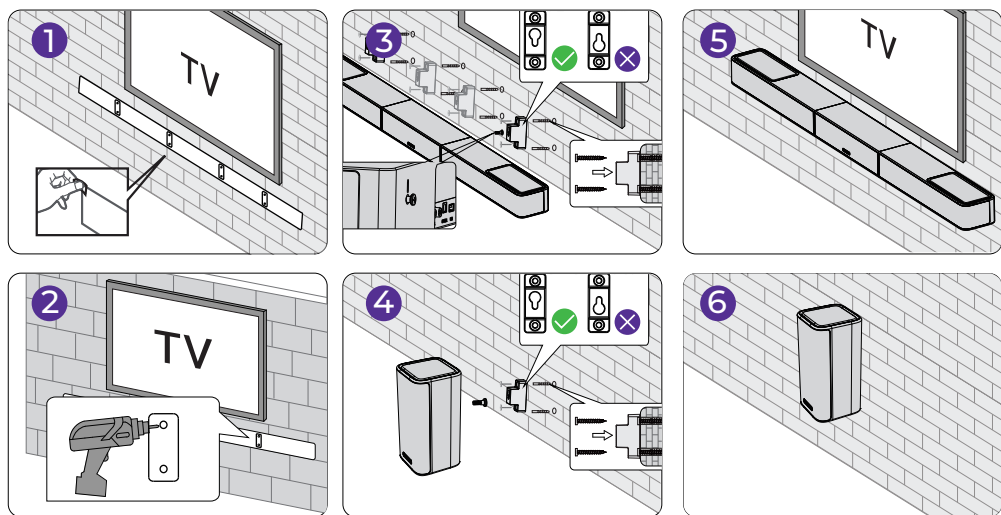

注意：环绕音箱使用的壁挂支架与 Soundbar 相同，垂直孔距与 Soundbar 一致。详见挂墙安装指南。

9. 连接并开机

- 1 将 Soundbar 电源适配器插入电源插座。

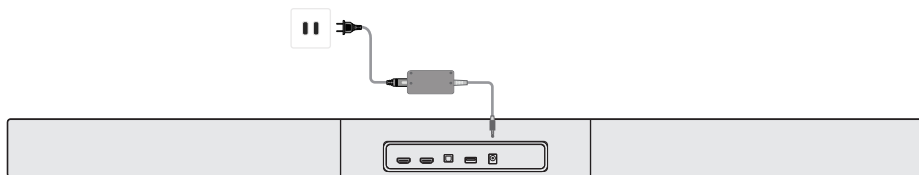

- 2 将低音炮电源线插入电源插座。

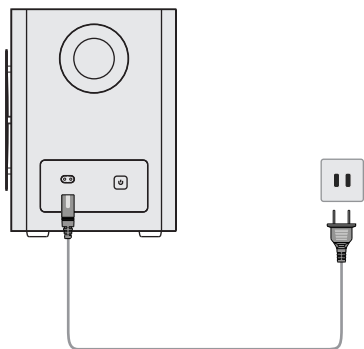

- 3 将每个环绕音箱电源适配器插入墙壁插座。

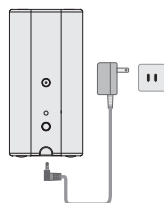

- 4 注意：建议使用一次性碱性电池，不建议使用可充电电池。

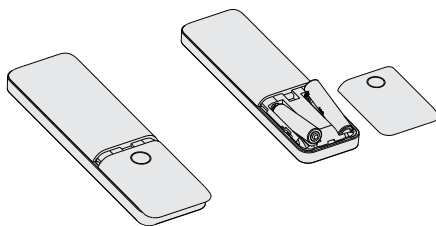

电池不包含在内。

10. 通过 HDMI eARC 连接电视

- 1 将 HDMI 线一端连接至电视背面的 eARC/ARC 接口。

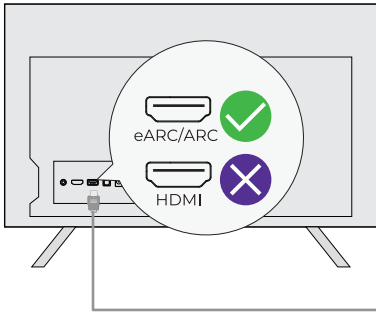

- 2 将另一端连接至 Soundbar 的 eARC 接口。

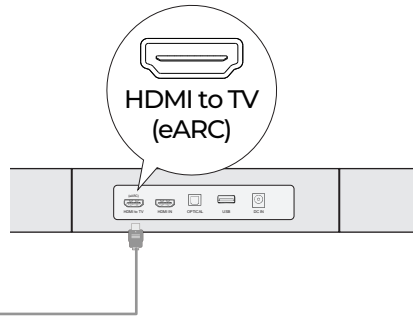

- 3 按下遥控器上的“Source”按键，选择“eARC”输入源。

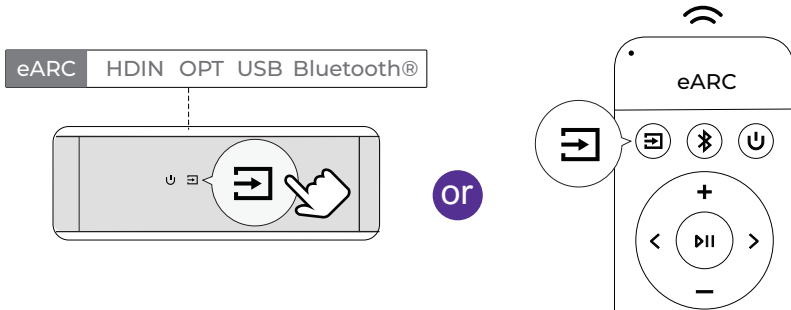

注意：请确认电视 HDMI 接口支持 eARC，否则无法传输 Dolby Atmos 音频信号。

Dolby Atmos: 如播放 Dolby Atmos 格式内容，请将电视音频输出设置为 Pass Through。

电视设置 > 首页 > 设置 > 声音 > 数字音频输出 > Pass Through

HDMI IN、HDMI ARC 和 HDMI eARC 有什么区别？

HDMI IN 是标准 HDMI 输入接口，用于连接外部设备，不支持 ARC 或 eARC。

HDMI ARC 支持电视与音响系统之间的双向音频传输。

HDMI eARC 是 ARC 的升级版，支持更高品质音频格式，如 Dolby Atmos。

注意：请开启电视的“CEC”功能。连接 eARC 或 ARC 后，电视遥控器可同时控制电视和 Soundbar：

- (1) 开机 / 待机
- (2) 调节音量

11. 通过光纤线连接电视

- 1 请确认电视接口为 OPTICAL OUT，并将光纤线两端分别连接至电视和音箱的 OPTICAL 接口。

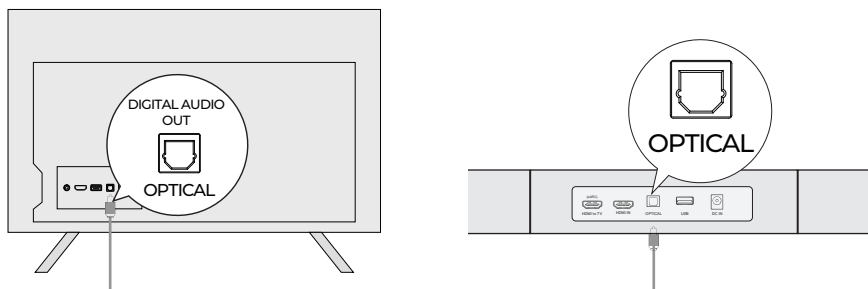

- 2 请确认光纤插头按照图示正确插入。请勿倒置插入，以免损坏光纤接口。

- 3 电视设置 > 主页 > 设置 > 声音 > 数字音频输出 > PCM

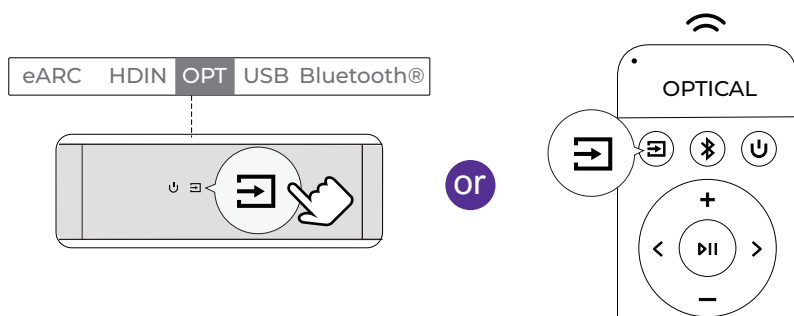

注意：如果声音仍从电视内置扬声器播放，请将电视静音或将音量调至最低。光纤接口不支持 Dolby Atmos，仅支持 Dolby Digital Plus (7.1)。如需获得最佳 Dolby Atmos 体验，请使用 HDMI IN 或 HDMI eARC 连接。

12. 连接外部设备

- 1 将 HDMI 线连接到电视的 HDMI eARC/ARC 接口。
- 2 将外部设备的 HDMI OUT 连接到 Soundbar 的 HDMI IN。

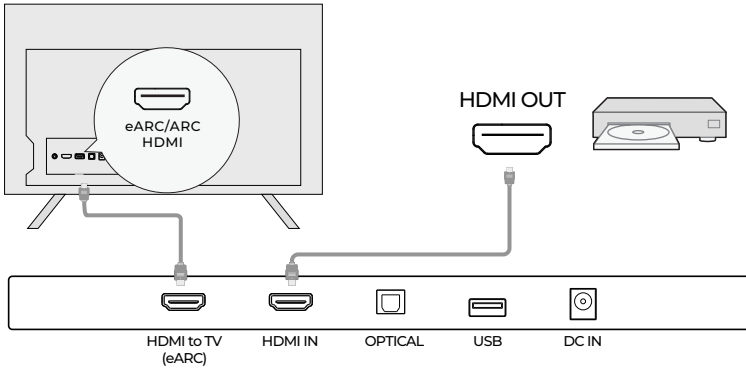

- 3 按下 Soundbar 或遥控器上的 “Source” 按键，选择 “HDIN” 输入。

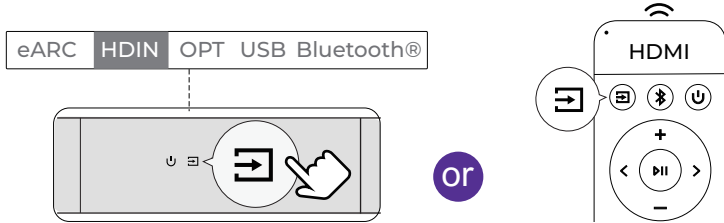

连接外部设备：电视盒子、DVD 播放器、Amazon Fire TV Cube、游戏主机等
示例：DVD 连接方式

步骤 1: 将 HDMI 线从 DVD 播放器（或其他外部设备）的 HDMI OUT 接口连接至音箱的 HDMI IN 接口。

步骤 2: 再使用一根 HDMI 线，将音箱的 HDMI OUT (eARC) 接口连接至电视的 HDMI eARC/ARC 接口。

注意：若需将 Dolby Atmos 音频传输至音箱，电视的 HDMI 接口必须支持 eARC 功能。

步骤 3: 按下音箱或遥控器上的 “Source” 按钮，切换至 HDMI IN 通道。

步骤 4: 将 DVD 播放器的音频输出格式设置为 “Bitstream” 或 “Auto”。

外部设备的替代连接方式

示例：Chromecast / Fire TV Stick

将 Chromecast 或 Fire TV Stick 插入电视的任意 HDMI IN 接口。

使用 HDMI 线将电视的 HDMI eARC/ARC 接口连接至音箱的 HDMI OUT (eARC) 接口。

将电视音频输出设置为 “外接扬声器” 或 “HDMI (ARC/eARC)”。

在音箱上选择 “TV/eARC” 作为输入源。

在电视上切换至 Chromecast 或 Fire TV Stick 所连接的 HDMI 输入源。

13. 连接Bluetooth®

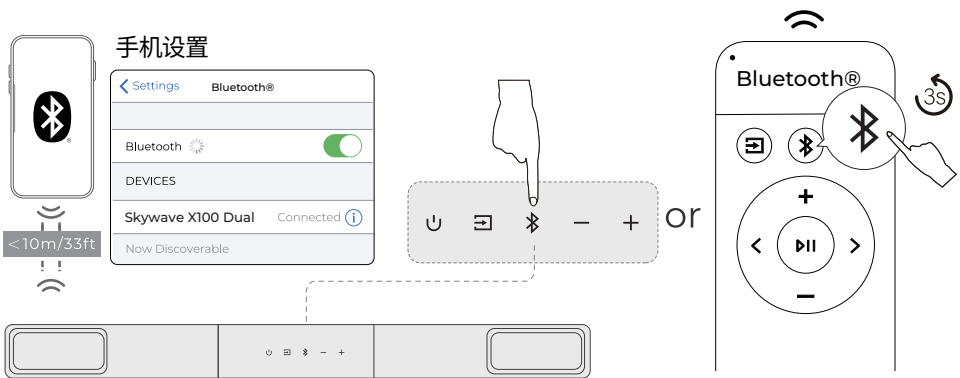

- 1 按下音箱上的 "Bluetooth" 按钮，或按下遥控器上的 "Bluetooth" 按钮进入Bluetooth®配对模式
- 2 打开手机Bluetooth®设置，找到并选择 "Skywave X100 Dual" 以连接音箱
- 3 注意：如果已处于Bluetooth®模式并已连接，请长按 "Bluetooth" 按钮3秒断开当前设备，然后在手机/PC/电视上手动选择新的设备进行连接

14. Auracast™ 接收模式

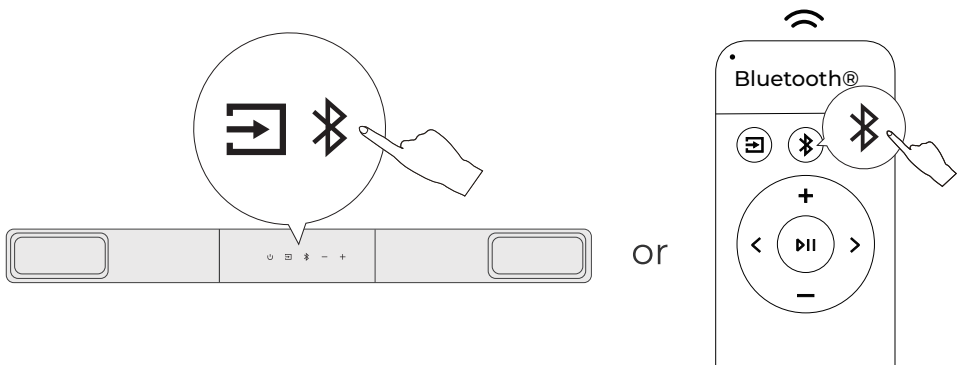

同时按下主机上的 Source 和 Bluetooth® 按键，或双击遥控器上的 Bluetooth® 按键，即可进入 Auracast™ 接收模式并加入可用广播。
重复该操作（或按 Source）可停止广播播放。

15. 重新配对低音炮

通常情况下，音箱与低音炮已在出厂时完成配对。如连接断开，请按照以下步骤重新配对：

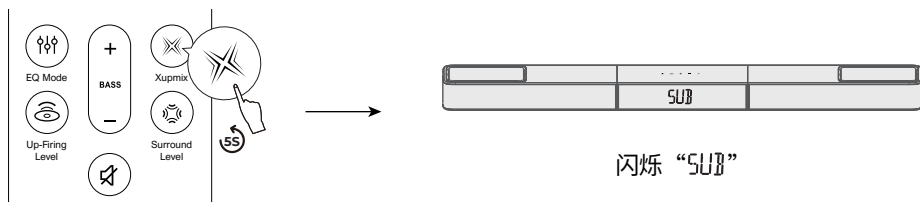

- 1 长按遥控器上的 "Xupmix" 按钮5秒，主机显示屏将闪烁 "SUB" 以表示进入配对模式

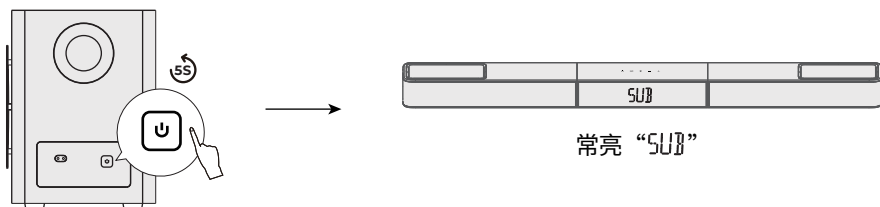

- 2 长按低音炮背面的配对按钮5秒，进入配对模式
- 3 配对成功后，主机显示屏将停止闪烁，低音炮指示灯将保持常亮

16. 重新配对环绕音箱

通常情况下，音箱与环绕音箱已在出厂时完成配对。如连接断开，请按照以下步骤重新配对：

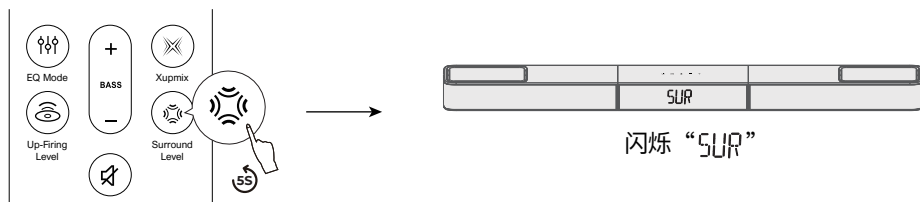

- 1 长按遥控器上的 "Surround Level" 按钮5秒，主机显示屏将闪烁 "SUR" 以表示进入配对模式

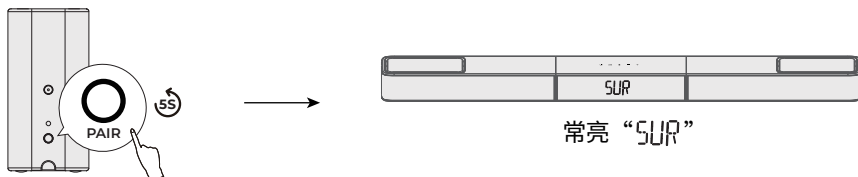

- 2 长按环绕音箱背面的配对按钮5秒，进入配对模式
- 3 配对成功后，主机显示屏将停止闪烁，环绕音箱指示灯将保持常亮

17. 遥控器重新连接

通常情况下，音箱与遥控器在出厂时已完成配对。如连接断开，请按照以下步骤重新配对：

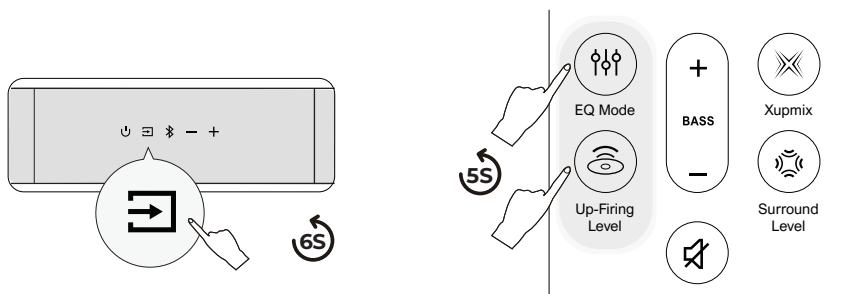

- 1 将音箱切换至 Bluetooth® 模式，并长按 Source 按钮约 6 秒
- 2 同时长按遥控器上的 "EQ Mode" 和 "Up-Firing Level" 按钮约 5 秒，进入遥控器配对模式

18. 恢复出厂设置

长按 MUTE 按钮 5 秒恢复出厂设置

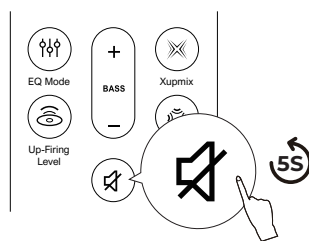

19. 调整提示音音量

如果您觉得Soundbar的提示音过大，可以通过ULTIMEA App调整音量。

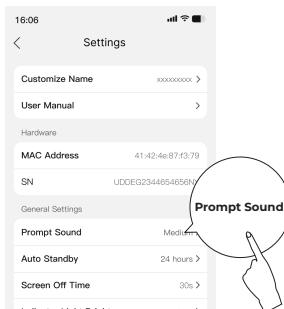
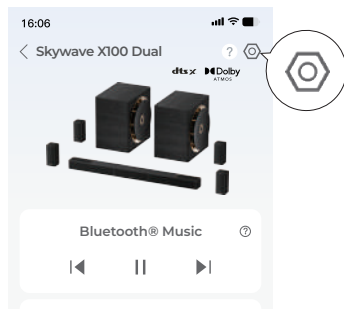

- 1 扫描二维码下载ULTIMEA App，然后在App中添加您的Soundbar。
- 2 打开Soundbar的设备详情页面，点击右上角的设置图标，选择“Prompt Sound Volume”，根据需要调整音量。

Model Number	U622A
Power Supply	DC 18V 5A(Soundbar) / DC 18V 1.5A(Surround)/ AC 110~220V(Subwoofer)
Soundbar Drivers	Soundbar:2.25" x6 + 2.25" x 2 , Surround: 2.25" x 4 + 2.25" x4, Subwoofer: 10" x 2
Auto Standby	The sounddbar will turn to standby mode if there is no audio signal for 15 minutes. You can set the standby time in the App
Standby Power	<0.5W
Operating Temperature	-10 C -45 C / 14 °F-113 °F
Bluetooth® Version	6.0

Soundbar	1102 x 100 x 70 mm / 43.39" × 3.94" × 2.76"
Subwoofer	260 x 355 x 355 mm / 10.2" × 14.0" × 14.0"
Surround Speaker	85 x85 x 170 mm / 3.35"× 3.35" × 6.69"
Packaging	1009 x 543 x 514 mm / 39.7" × 21.3" × 21.2"
Net Weight	37.2kg / 82 lbs
Gross Weight	45,5kg / 100.3 lbs

USB Output	5V 500mA
Operating Altitude	2000 meters above sea level
Wall Mount Screw	4 x 35 mm / 0.16" x 1.4"
Bracket Screws Diameter	M5*10mm / 0.2" x 0.4"
Remote Control Battery Type	2 x AAA (NOT INCLUDED)
Notice: Risk of fire or explosion if the battery is replaced by an incorrect type.	

PROPER DISPOSAL INSTRUCTIONS



This mark shown on the product or its packaging, indicates that this product should not be disposed of with other household waste at the end of its working life. To prevent possible harm to the environment or human health from uncontrolled waste disposal, please separate this from other types of wastes and recycle it responsibly to promote the sustainable reuse of material resources.

WASTE ELECTRICAL & ELECTRONIC EQUIPMENT

Household user should contact either the retailer where they purchased this product, or their local government office, for details of where and how they can take this item for environmentally safe recycling. Business users should contact their suppliers and check the terms and conditions of the purchase contract. This product should not be mixed with other commercial wastes for disposal.

WIRELESS FREQUENCY RANGE AND WIRELESS OUTPUT POWER:

Frequency: 2.402GHz-2.48GHz,5.8GHz
Soundbar Bluetooth® Max.transmit power: 10dBm
Soundbar wireless Max.transmit power: 10dBm
Surround wireless Max.transmit power: 10dBm

FCC REGULATORY COMPLIANCE

Any changes or modifications not expressly approved by the party responsible for compliance could void the user's authority to operate the equipment.

This device complies with Part 15 of the FCC Rules.

Operation is subject to the following two conditions:

(1) This device may not cause harmful interference.

(2) This device must accept any interference received, including interference that may cause undesired operation.

NOTE: This equipment has been tested and found to comply with the limits for a Class B digital device, pursuant to part 15 of the FCC Rules. These limits are designed to provide reasonable protection against harmful interference in a residential installation. This equipment generates, uses, and can radiate radio frequency energy, and if not installed and used in accordance with the instructions, may cause harmful interference to radio communications.

However, there is no guarantee that interference will not occur in a particular installation. If this equipment does cause harmful interference to radio or television reception, which can be determined by turning the equipment off and on, the user is encouraged to try to correct the interference by one or more of the following measures:

- Reorient or relocate the receiving antenna.

- Increase the separation between the equipment and the receiver.

- Connect the equipment to an outlet on a circuit different from that to which the receiver is connected.

- Consult the dealer or an experienced radio / TV technician for help.

This equipment complies with FCC radiation exposure limits set forth for an uncontrolled environment. This equipment should be installed and operated with a minimum distance of 20cm between the radiator & your body. This transmitter must not be co-located or operating in conjunction with any other antenna or transmitter.

CE WARNINGS

(1) Do not install this equipment in a confined or building-in space such as a book case or similar unit, and remain a well ventilation conditions. The ventilation should not be impeded by covering the ventilation openings with items such as newspaper, table-cloths, curtains etc.

(2) WARNING: To reduce the risk of fire or electric shock, do not expose this apparatus to rain or moisture. The apparatus shall not be exposed to dripping or splashing and that objects filled with liquids, such as vases, shall not be placed on apparatus.

(3) WARNING: The adapter plug is used as disconnect device, the disconnect device shall remain readily operable.

(4) Frequency: 2.402GHz-2.48GHz

(5) The Max. transmit power: 10 dBm

▲ WARNING: This product can expose you to chemicals including lead, which is known to the State of California to cause cancer and birth defects or other reproductive harm. For more information, go to www.P65Warnings.ca.gov.

Trade Marks:



Dolby, Dolby Atmos, and the double-D symbol are registered trademarks of Dolby Laboratories Licensing Corporation. Manufactured under license from Dolby Laboratories. Confidential unpublished works. Copyright © 2012–2024 Dolby Laboratories. All rights reserved.



Manufactured under license from DTS, Inc. and/or its affiliates. For patents, see <https://xperi.com/dts-patents/>. DTS, the DTS logo, DTS:X, the DTS:X logo, Virtual:X, and the DTS Virtual:X logo are trademarks or registered trademarks of DTS, Inc. and/or its affiliates in the U.S. and/or other countries. © DTS, Inc. and/or its affiliates. All rights reserved.



The Bluetooth® word mark and logos are registered trademarks owned by Bluetooth SIG, Inc. The Auracast™ word mark and logos are trademarks owned by the Bluetooth SIG. Any use of such marks by Ultimea Technology (Shenzhen) Limited is under license. Other trademarks and trade names are those of their respective owners.



The terms HDMI, HDMI High-Definition Multimedia Interface, HDMI trade dress and the HDMI Logos are trademarks or registered trademarks of HDMI Licensing Administrator, Inc.



THX and the THX Logo are the property of THX Ltd., registered in the U.S. and other countries. Tuned by THX is a trademark belonging to THX Ltd.

ULTIMEA

Product Name: Soundbar
Model No.: U622A

EC REP Ultimea GmbH
Buchenring 57, 22359 Hamburg, Germany

UK REP EVATOST CONSULTING LTD
Office 101 32 Threadneedle Street, London, United Kingdom, EC2R 8AY

@Ultimea Inc. All rights reserved, registered in the United States and other countries. 801 S. Dupont Ave., Ste G, Ontario, CA, 91761, USA

Made in China
Manufacturer: Ultimea Technology (Shenzhen) Limited
Address: 20th Floor, Building 4, Tianan Cloud Park, Bantian St., Longgang District, Shenzhen, China 518000

Manufacturer Contact Information:

☎ +1 888-598-8875 (US) ☎ +49 89-628-25828 (EU) ✉ support@ultimea.com 🌐 support.ultimea.com
Mon-Fri 9am-5pm (PST) Mon-Fri 9am-5pm (CET)

If you need our support, kindly reach out to our service team. We are always glad to help.



Warranty Extension Plan

EU DECLARATION OF CONFORMITY

We (Manufacturer) is responsible for this declaration)
20th Floor, Building 4, Tianan Cloud Park, Bantian St.,
Declare under our sole responsibility that the product
Trade Mark: ULTIMEA
Product Name: Soundbar
Model No.: U622A

Ultimea Technology (Shenzhen) Limited
Longgang District Shenzhen, China 518000

The product to which this declaration relates is in conformity with the essential requirements set out in the Council Directive on the Approximation of the laws of the Member States relating to the Radio Equipment Directive (2014/53/EU), the Restriction of Hazardous Substances Directive (2011/65/EU), the Electromagnetic Compatibility Directive (2014/30/EU), and the Low Voltage Directive (2014/35/EU). The product is responsible for affixing the CE marking, and the following standards were applied:

EN 55032:2015/A1:2020
EN 55035:2017/A11:2020
EN IEC 61000-3-2:2019/A2:2024
EN 61000-3-3:2013/A2:2021

ETSI EN 301 489-1 V2.2.3 (2019-11)
ETSI EN 301 489-17 V3.2.4 (2020-09)
ETSI EN 300 328 V2.2.2 (2019-07)
EN IEC 62311:2020
EN IEC 62368-1:2020+A11:2020

Full Name: Yoyo.Yu
Position: Approval Manager
Signature: 
Place/Date: Shenzhen, China / March 10, 2026