

ULTIMEA



Ultimea Skywave X100 Dual

使用手冊



最新說明書

1 重要安全說明

- 請閱讀並妥善保存本說明。請遵循所有警告提示，並依照說明操作。
- 請勿在靠近水源、潮濕環境或雨中使用本設備。避免將液體灑在設備上，或放置盛有液體的物品（如花瓶）。
- 僅可使用乾布清潔。請勿使用液體清潔劑。
- 請勿堵塞通風孔，亦不可將設備安裝於密閉空間。請確保良好通風，並依照製造商說明安裝。
- 請勿將設備安裝於散熱器、爐具、擴大機或其他產生熱量的設備附近。請勿以報紙、窗簾等物品覆蓋通風孔。
- 僅使用製造商指定之附件或配件。使用帶輪設備移動時，請小心避免傾倒。
- 請保護電源線，避免踩踏、夾壓或彎折，特別是在插頭與設備連接處。
- 請勿改動插頭之極性或接地功能。如插頭無法插入插座，
- 請諮詢電工更換插座。
- 雷雨期間或長時間不使用時，請拔除電源插頭。
請勿在設備上放置任何明火，如點燃的蠟燭。
- 請勿嘗試拆解設備。內部高電壓可能導致觸電或死亡。
維修必須由專業人員進行。
- 安裝高度不得超過2公尺。

2 配件清單

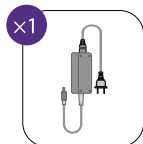
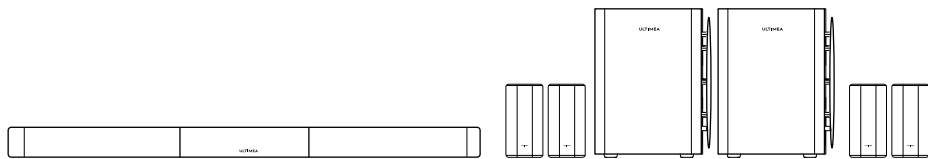

音響電源轉接器
(3 m / 118")

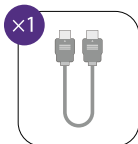

HDMI 線
(1.5 m / 59")

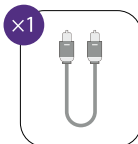

數位光纖線
(1.5 m / 59")



重低音電源線
(2 m / 78")

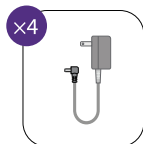

環繞電源轉接器
(3 m / 118")

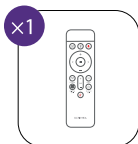

遙控器

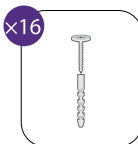

壁掛螺絲
及膨脹管

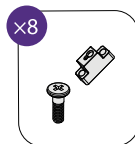



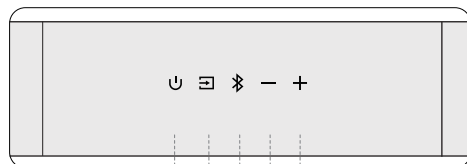

安裝支架及
螺絲

3 Soundbar 控制說明



1 2 3 4 5

控制面板

- 1 “”: 電源鍵
按下開機或進入待機模式。
- 2 “”: 訊號源
按下切換輸入來源: eARC - HDMI IN - OPT (OPTICAL) - Bluetooth® - USB。
- 3 “”: Bluetooth®
按下切換至 Bluetooth® 模式, Soundbar 將自動進入配對模式。長按 3 秒可中斷目前裝置連線, 並透過手機、電腦或電視手動配對新裝置。
- 4 “”: 音量降低
- 5 “”: 音量增加

4 遙控器

- 1 “U”：電源鍵
按下開機 / 待機
- 2 “☐”：SOURCE
按下切換輸入來源
- 3 “Bluetooth®”
按下切換至Bluetooth®模式
- 4 “+”：音量增加
- 5 “-”：音量降低
- 6 “<”：上一曲
僅於Bluetooth®及USB模式使用 切換至上一曲
- 7 “>”：下一曲
僅於Bluetooth®及USB模式使用 切換至下一曲
- 8 “▶||”：播放 / 暫停
僅於Bluetooth®及USB模式使用
- 9 “EQ”：EQ模式
按下切換EQ模式
標準、影院、音樂、人聲、遊戲、夜間
- 10 “Xupmix”：Xupmix
預設為「開啟」，
可統一控制6種音效模式的啟用與關閉
Xupmix 開啟 環繞聲道經由演算法處理為多
聲道訊號，帶來更沉浸的聆聽體驗
Xupmix 關閉 環繞聲道依據左右聲道訊號進
行優化，呈現更寬廣的音場效果
- 11 BASS
按下調整低音等級
- 12 “Up-Firing Level”
按下調整天空聲道音量
- 13 “Surround Level”
按下調整環繞聲等級
- 14 “MUTE”
按下靜音
長按5秒恢復出廠設定

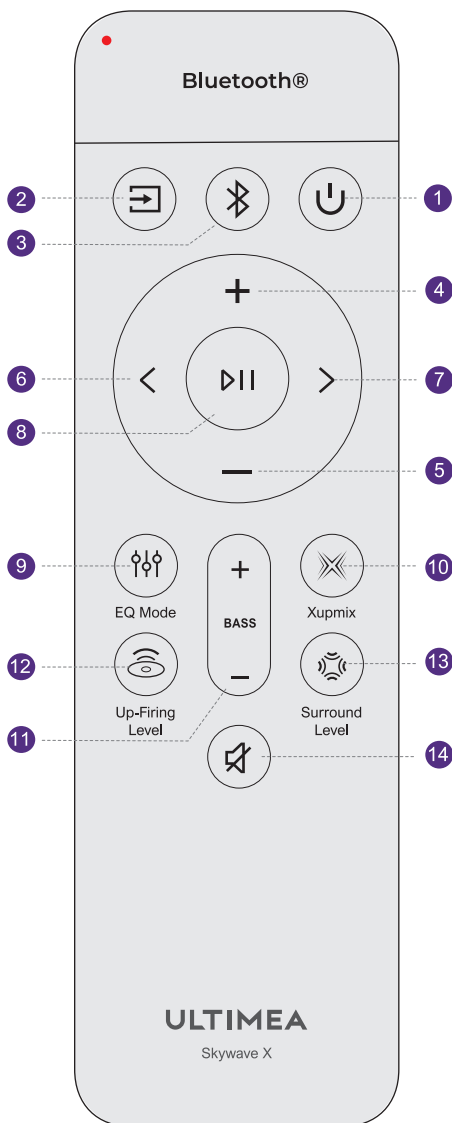

注意：同時長按「<」與「>」3秒可調整遙控器背光熄滅時間。設定較短的熄滅時間有助於延長電池壽命。

5 Soundbar 安裝

將三段接頭對齊後旋轉鎖緊，直至牢固連接。

注意：組裝過程中請確保 Soundbar 已關閉電源。

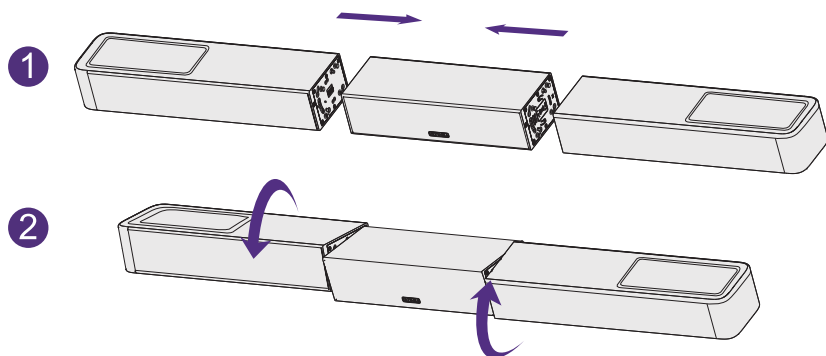

6 后面板

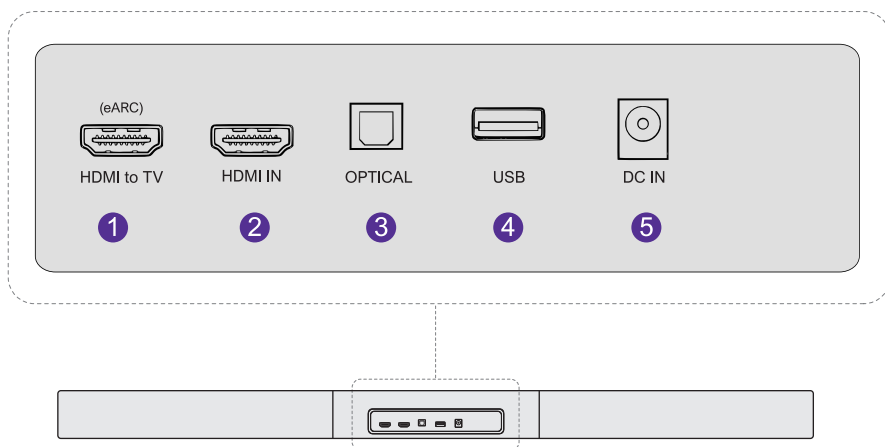

注意：USB 支援 MP3 或 FLAC 檔案。

7 系統擺放

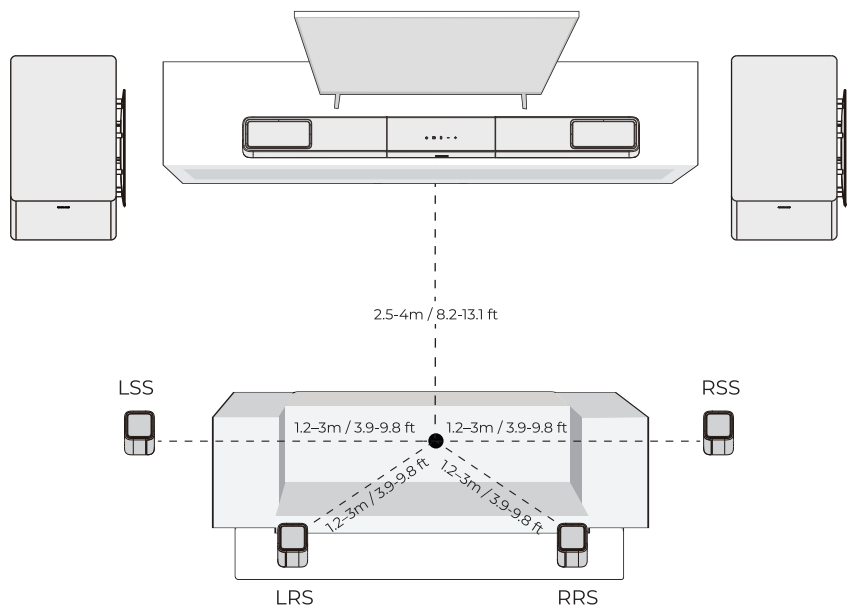

8 壁掛安裝

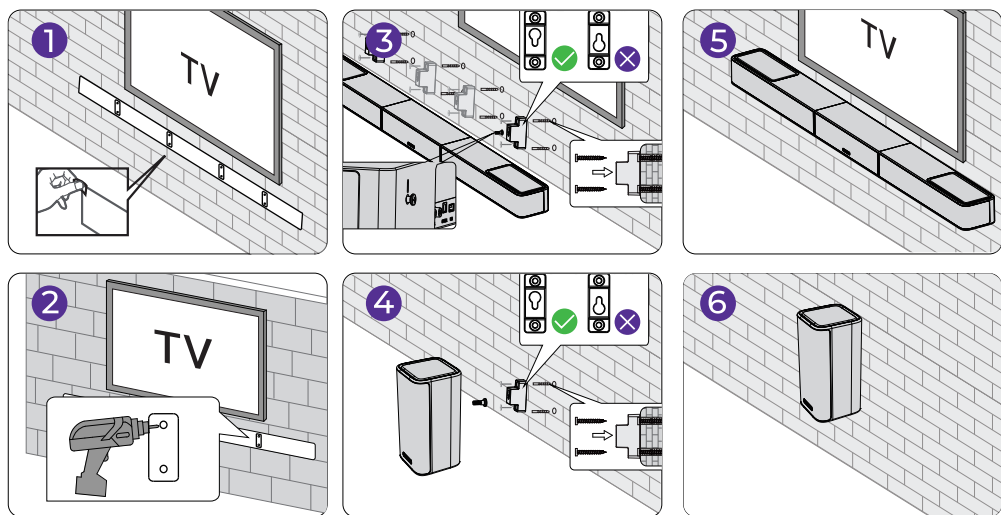

注意：環繞喇叭使用的壁掛支架與 Soundbar 相同，垂直孔距與 Soundbar 一致。詳見壁掛安裝指南。

9 連接並開機

- 1 將 Soundbar 電源轉接器插入電源插座。

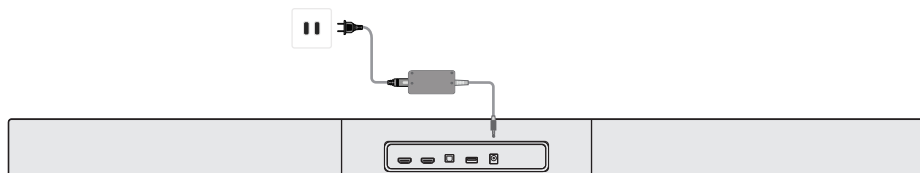

- 2 將重低音電源線插入電源插座。

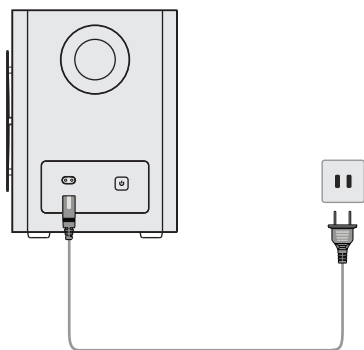

- 3 將環繞音箱連接至電源插座。

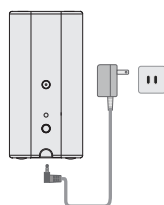

- 4 注意：建議使用一次性鹼性電池，不建議使用可充電電池。

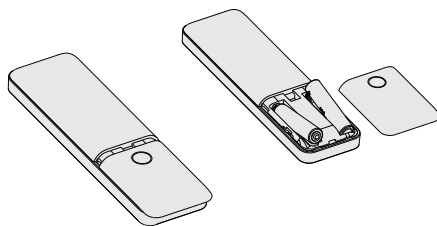

電池不包含在內。

10 透過 HDMI eARC 連接電視

- 1 將 HDMI 線一端連接至電視背面的 eARC/ARC 連接埠。
- 2 將另一端連接至 Soundbar 的 eARC 連接埠。

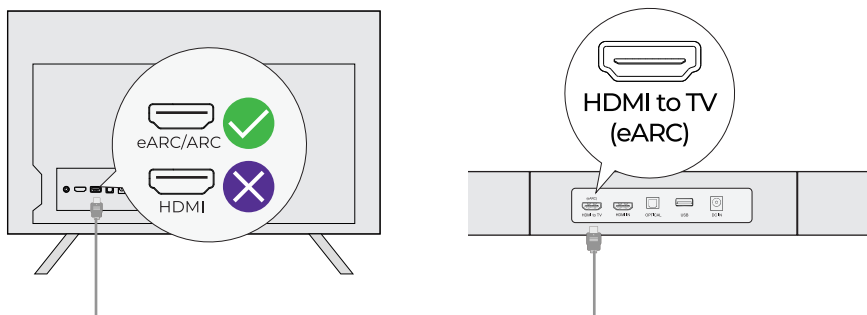

- 3 按下遙控器上的「Source」按鍵，選擇「eARC」輸入來源。

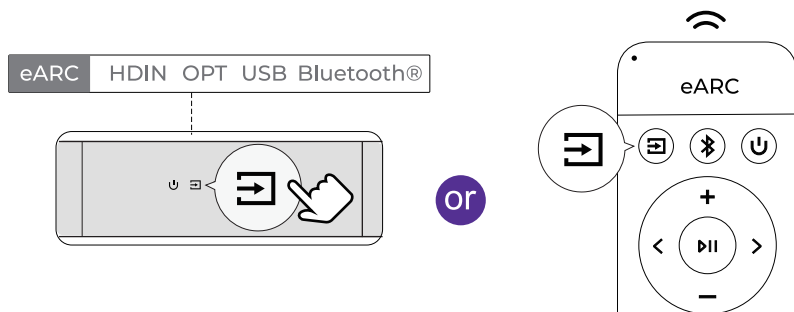

注意：請確認電視 HDMI 連接埠支援 eARC，否則無法傳輸 Dolby Atmos 音訊訊號 Atmos 音頻信號。

Dolby Atmos：如播放 Dolby Atmos 格式內容，請將電視音訊輸出設定為 **Pass Through**。

電視設定 > 首頁 > 設定 > 聲音 > 數位音訊輸出 > **Pass Through**

HDMI IN、**HDMI ARC** 和 **HDMI eARC** 有何差異？

HDMI IN 為標準 HDMI 輸入接口，不支援 **ARC** 或 **eARC**。

HDMI ARC 支援電視與音響系統之間的雙向音訊傳輸。

HDMI eARC 為 **ARC** 的升級版本，支援 **Dolby Atmos** 等高品質音訊格式。

注意：請開啟電視的「**CEC**」功能。連接 **eARC** 或 **ARC** 後，電視遙控器可同時控制電視與 **Soundbar**：

- (1) 開機 / 待機
- (2) 調整音量

11 透過光纖線連接電視

- 1 請確認電視接口為 **OPTICAL OUT**，並將光纖線兩端分別連接至電視與音響的 **OPTICAL** 接口的 **OPTICAL** 接口。

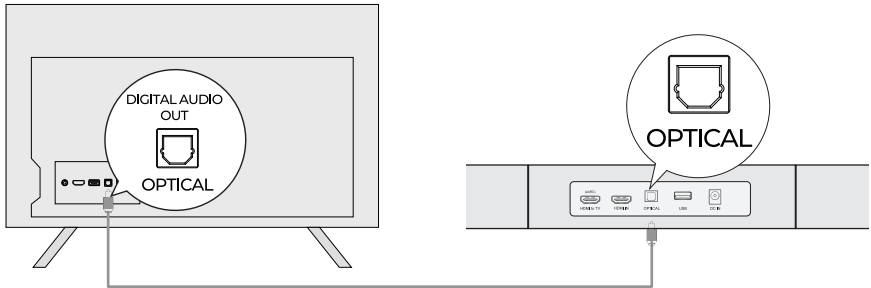

- 2 請確認光纖插頭依照圖示正確插入。請勿上下顛倒插入，以免損壞光纖接口。
- 3 電視設定 > 主頁 > 設定 > 聲音 > 數位音訊輸出 > PCM

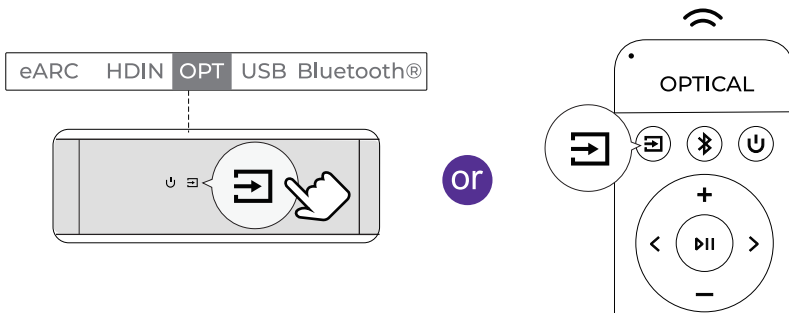

注意：若聲音仍由電視內建喇叭播放，請將電視靜音或將音量調至最低。光纖接口不支援 **Dolby Atmos**，僅支援 **Dolby Digital Plus (7.1)**。如需最佳 **Dolby Atmos** 體驗，請使用 **HDMI IN** 或 **HDMI eARC**。

12 連接外部裝置

- 1 將 HDMI 線連接到電視的 eARC/ARC/HDMI 接口。

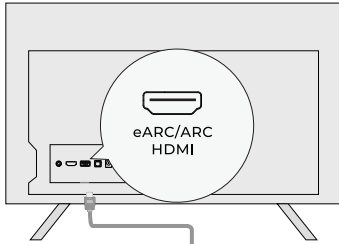

- 2 將外部裝置的 HDMI OUT 連接到 Soundbar 的 HDMI IN。

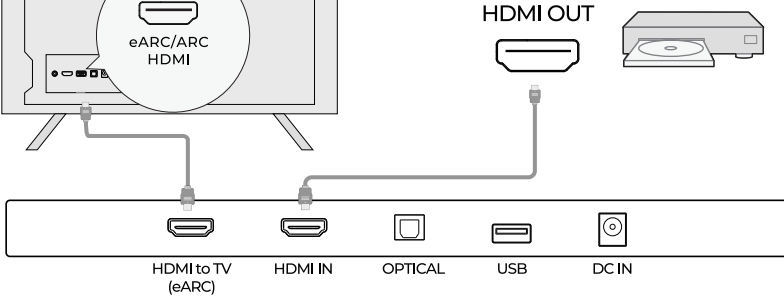

- 3 按下 Soundbar 或遙控器上的「Source」按鍵，選擇「HDIN」輸入。

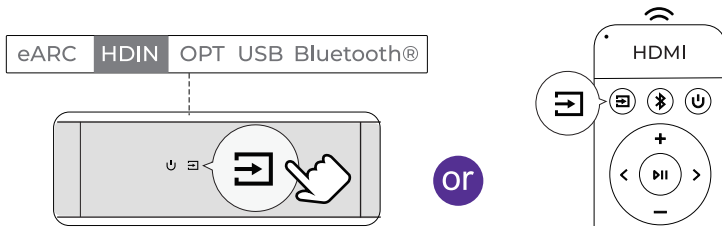

連接外部設備：電視盒子、DVD 播放器、Amazon Fire TV Cube、遊戲主機等
範例：DVD 連接方式

- 步驟 1: 將 HDMI 線從 DVD 播放器（或其他外部設備）的 HDMI OUT 端口連接至音響的 HDMI IN 端口。
步驟 2: 再使用一條 HDMI 線，將音響的 HDMI OUT（eARC）端口連接至電視的 HDMI eARC/ARC 端口。
注意：若需將 Dolby Atmos 音訊傳輸至音響，電視的 HDMI 端口必須支援 eARC 功能。
步驟 3: 按下音響或遙控器上的「Source」按鈕，切換至 HDMI IN 頻道。

設置

- 步驟 1: 將音響輸入模式設定為「HDMI IN」。
步驟 2: 將 DVD 播放器的音訊輸出格式設定為「Bitstream」或「Auto」。

外部設備的替代連接方式

範例：Chromecast / Fire TV Stick

- 將 Chromecast 或 Fire TV Stick 插入電視的其中一個 HDMI IN 端口。
使用 HDMI 線將電視的 HDMI eARC/ARC 端口連接至音響的 HDMI OUT（eARC）端口。
將電視音訊輸出設定為「外接喇叭」或「HDMI（ARC/eARC）」。
在音響上選擇「TV/eARC」作為輸入來源。
在電視上切換至 Chromecast 或 Fire TV Stick 所連接的 HDMI 輸入來源。

13 連接Bluetooth®

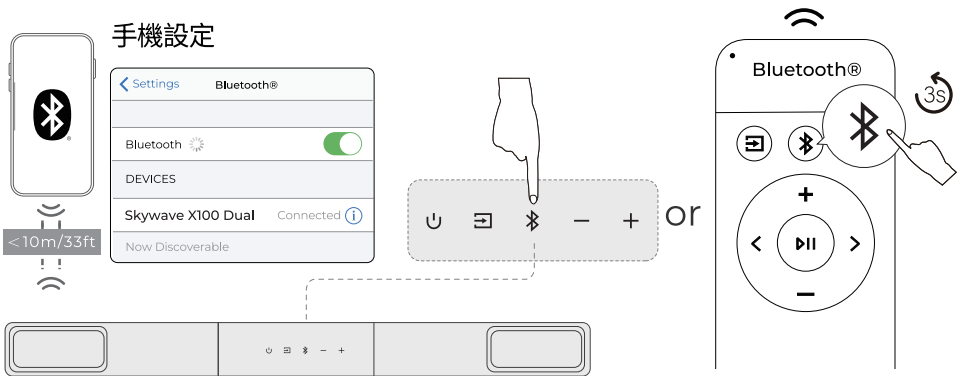

- 1 按下音響上的 "Bluetooth" 按鈕，或按下遙控器上的 "Bluetooth" 按鈕進入Bluetooth® 配對模式
- 2 開啟手機Bluetooth®設定，找到並選擇 "Skywave X100 Dual" 以連接音響
- 3 注意：若已處於Bluetooth®模式且已連接，請長按 "Bluetooth" 按鈕3秒以中斷目前裝置，然後在手機 / PC / 電視上手動選擇新的裝置進行連接

14 Auracast™ 接收模式

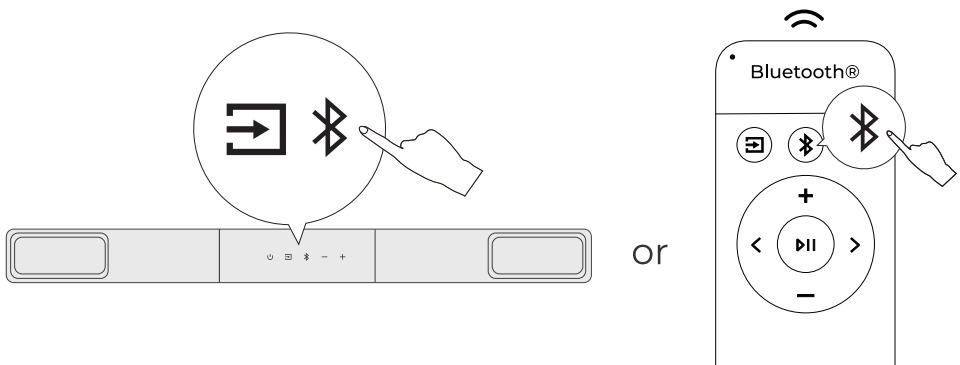

同時按下主機上的 **Source** 和 Bluetooth® 按鍵，或雙擊遙控器上的 Bluetooth® 按鍵，即可進入 Auracast™ 接收模式 並加入可用廣播。
重複此操作（或按 **Source**）即可停止廣播播放。

15 重新配對重低音

通常情況下，音響與重低音已在出廠時完成配對。如連線中斷，請依照以下步驟重新配對：

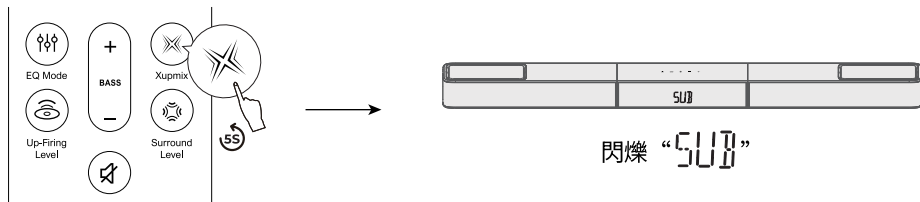

- 1 長按遙控器上的 "Xupmix" 按鈕5秒，主機顯示幕將閃爍 "SUB" 表示進入配對模式

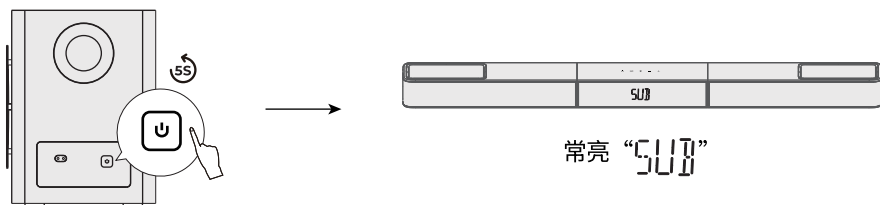

- 2 長按重低音背面的配對按鈕5秒，進入配對模式
- 3 配對成功後，主機顯示幕將停止閃爍，重低音指示燈將保持常亮

16 重新配對環繞音箱

通常情況下，音響與環繞喇叭已在出廠時完成配對。如連線中斷，請依照以下步驟重新配對：

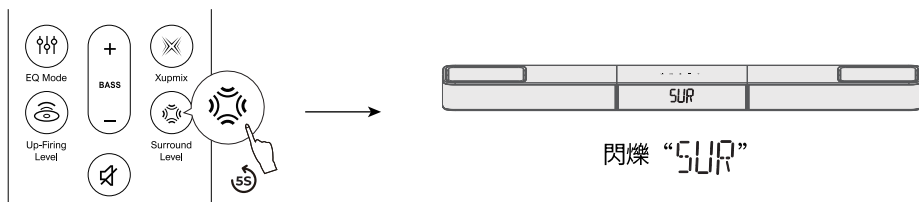

- 1 長按遙控器上的 "Surround Level" 按鈕5秒，主機顯示幕將閃爍 "SUR" 表示進入配對模式

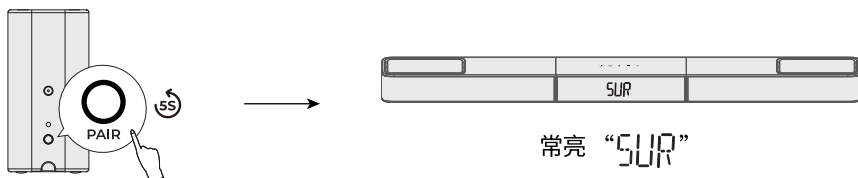

- 2 長按環繞喇叭背面的配對按鈕5秒，進入配對模式
- 3 配對成功後，主機顯示幕將停止閃爍，環繞喇叭指示燈將保持常亮

17 遙控器重新連接

通常情況下，音響與遙控器在出廠時已完成配對。如連線中斷，請依照以下步驟重新配對：

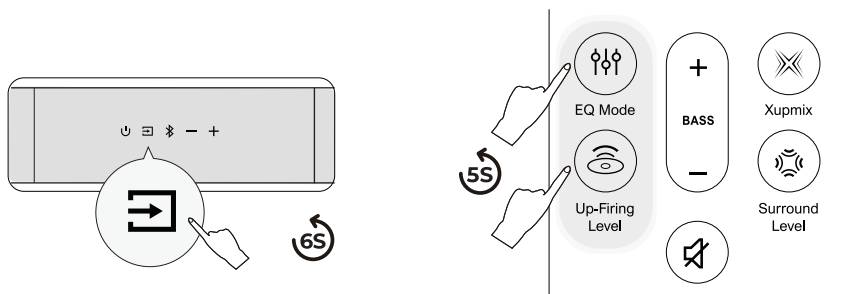

- 1 將音響切換至 Bluetooth® 模式，並長按 Source 按鈕約 6 秒
- 2 同時長按遙控器上的 "EQ Mode" 和 "Up-Firing" 按鈕約 5 秒，進入遙控器配對模式

18 恢復出廠設定

長按 MUTE 按鈕 5 秒恢復出廠設定

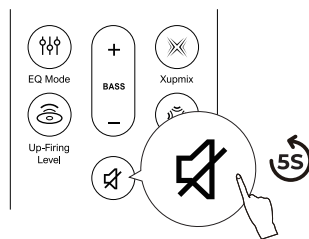

19 調整提示音音量

如果您覺得Soundbar的提示音過大，可以透過ULTIMEA App調整音量。

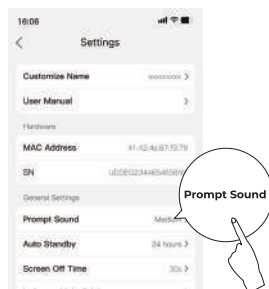
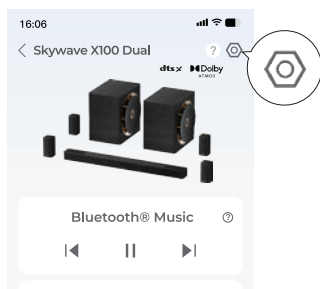

- 1 掃描QR碼下載ULTIMEA App，然後在App中新增您的Soundbar。
- 2 開啟Soundbar的裝置詳細頁面，點擊右上角的設定圖示，選擇「Prompt Sound Volume」，並依需求調整音量。

Model Number	U622A
Power Supply	18V--5A(Soundbar) / DC 18V--1.5A(Surround)/ AC 110~220V(Subwoofer)
Soundbar Drivers	Soundbar:2.25" x6 + 2.25" x 2 , Surround: 2.25" x 4 + 2.25" x4, Subwoofer: 10" x 2
Frequency Response	18Hz - 20kHz (-6dB)
Auto Standby	The soundbar will turn to standby mode if there is no audio signal for 15 minutes. You can set the standby time in the App
Standby Power	<0.5W
Operating Temperature	-10 C -45 C / 14°F-113°F
Bluetooth® Version	6.0

Soundbar	1102 x 100 x 70 mm / 43.39" x 3.94" x 2.76"
Subwoofer	260 x 355 x 355 mm / 10.2" x 14.0" x 14.0"
Surround Speaker	85 x85 x 170 mm / 3.35" x 3.35" x 6.69"
Packaging	1009 x 543 x 514 mm / 39.7" x 21.3" x 21.2"
Net Weight	37.2kg / 82 lbs
Gross Weight	45.5kg / 100.3 lbs

USB Output	5V 500mA
Operating Altitude	2000 meters above sea level
Wall Mount Screw	4 x 35 mm / 0.16" x 1.4"
Bracket Screws Diameter	M5*10mm / 0.2" x 0.4"
Remote Control Battery Type	2 x AAA (NOT INCLUDED)
Notice: Risk of fire or explosion if the battery is replaced by an incorrect type.	

PROPER DISPOSAL INSTRUCTIONS



This mark shown on the product or its packaging, indicates that this product should not be disposed of with other household waste at the end of its working life. To prevent possible harm to the environment or human health from uncontrolled waste disposal, please separate this from other types of wastes and recycle it responsibly to promote the sustainable reuse of material resources.

WASTE ELECTRICAL & ELECTRONIC EQUIPMENT

Household user should contact either the retailer where they purchased this product, or their local government office, for details of where and how they can take this item for environmentally safe recycling. Business users should contact their suppliers and check the terms and conditions of the purchase contract. This product should not be mixed with other commercial wastes for disposal.

WIRELESS FREQUENCY RANGE AND WIRELESS OUTPUT POWER:

Frequency: 2.402GHz-2.48GHz,5.8GHz
Soundbar Bluetooth® Max.transmit power: 10dBm
Soundbar wireless Max.transmit power: 10dBm
Surround wireless Max.transmit power: 10dBm

FCC REGULATORY COMPLIANCE

Any changes or modifications not expressly approved by the party responsible for compliance could void the user's authority to operate the equipment.

This device complies with Part 15 of the FCC Rules.

Operation is subject to the following two conditions:

(1) This device may not cause harmful interference.

(2) This device must accept any interference received, including interference that may cause undesired operation.

NOTE: This equipment has been tested and found to comply with the limits for a Class B digital device, pursuant to part 15 of the FCC Rules. These limits are designed to provide reasonable protection against harmful interference in a residential installation. This equipment generates, uses, and can radiate radio frequency energy, and if not installed and used in accordance with the instructions, may cause harmful interference to radio communications.

However, there is no guarantee that interference will not occur in a particular installation. If this equipment does cause harmful interference to radio or television reception, which can be determined by turning the equipment off and on, the user is encouraged to try to correct the interference by one or more of the following measures:

- Reorient or relocate the receiving antenna.

- Increase the separation between the equipment and the receiver.

- Connect the equipment to an outlet on a circuit different from that to which the receiver is connected.

- Consult the dealer or an experienced radio / TV technician for help.

This equipment complies with FCC radiation exposure limits set forth for an uncontrolled environment. This equipment should be installed and operated with a minimum distance of 20cm between the radiator & your body. This transmitter must not be co-located or operating in conjunction with any other antenna or transmitter.

CE WARNINGS

(1) Do not install this equipment in a confined or building-in space such as a book case or similar unit, and remain a well ventilation conditions. The ventilation should not be impeded by covering the ventilation openings with items such as newspaper, table-cloths, curtains etc.

(2) WARNING: To reduce the risk of fire or electric shock, do not expose this apparatus to rain or moisture. The apparatus shall not be exposed to dripping or splashing and that objects filled with liquids, such as vases, shall not be placed on apparatus.

(3) WARNING: The adapter plug is used as disconnect device, the disconnect device shall remain readily operable.

(4) Frequency: 2.402GHz-2.48GHz

(5) The Max. transmit power: 10 dBm

▲ WARNING: This product can expose you to chemicals including lead, which is known to the State of California to cause cancer and birth defects or other reproductive harm. For more information, go to www.P65Warnings.ca.gov.

ULTIMEA

Product Name: Soundbar

Model No.: U622A

EC REP Utimea GmbH
Buchenring 57, 22359 Hamburg, Germany

UK REP EVATOST CONSULTING LTD
Office 101 32 Threadneedle Street, London, United Kingdom, EC2R 8AY

@Utimea Inc. All rights reserved, registered in the United States and other countries. 801 S. Dupont Ave., Ste G, Ontario, CA, 91761, USA

Made in China

Manufacturer: Utimea Technology (Shenzhen) Limited

Address: 20th Floor, Building 4, Tianan Cloud Park, Bantian St., Longgang District, Shenzhen, China 518000

Manufacturer Contact Information:

+1 888-598-8875 (US)
Mon-Fri 9am-5pm (PST)

+49 89-628-25828 (EU)
Mon-Fri 9am-5pm (CET)

✉ support@ultimea.com

🌐 support.ultimea.com

If you need our support, kindly reach out to our service team. We are always glad to help.



RoHS



FR
Cet appareil,
ses accessoires,
et cordons
se recyclent

REPRISE
À LA LIVRAISON

OU

À DÉPOSER
EN MAGASIN

OU

À DÉPOSER
EN DÉCHÈTERIE

OU

Points de collecte sur www.uefairedemesdechets.fr



Warranty Extension Plan

Trade Marks:



Dolby, Dolby Atmos, and the double-D symbol are registered trademarks of Dolby Laboratories Licensing Corporation. Manufactured under license from Dolby Laboratories. Confidential unpublished works. Copyright © 2012–2024 Dolby Laboratories. All rights reserved.



Manufactured under license from DTS, Inc. and/or its affiliates. For patents, see <https://xperi.com/dts-patents/>. DTS, the DTS logo, DTS:X, the DTS:X logo, Virtual:X, and the DTS Virtual:X logo are trademarks or registered trademarks of DTS, Inc. and/or its affiliates in the U.S. and/or other countries. © DTS, Inc. and/or its affiliates. All rights reserved.



The Bluetooth® word mark and logos are registered trademarks owned by Bluetooth SIG, Inc. The Auracast™ word mark and logos are trademarks owned by the Bluetooth SIG. Any use of such marks by Ultimea Technology (Shenzhen) Limited is under license. Other trademarks and trade names are those of their respective owners.



The terms HDMI, HDMI High-Definition Multimedia Interface, HDMI trade dress and the HDMI Logos are trademarks or registered trademarks of HDMI Licensing Administrator, Inc.



THX and the THX Logo are the property of THX Ltd., registered in the U.S. and other countries. Tuned by THX is a trademark belonging to THX Ltd.

EU DECLARATION OF CONFORMITY

We (Manufacturer is responsible for this declaration)
20th Floor, Building 4, Tianan Cloud Park, Bantian St.,
Declare under our sole responsibility that the product
Trade Mark: ULTIMEA
Product Name: Soundbar
Model No.: U622A

Ultimea Technology (Shenzhen) Limited
Longgang District Shenzhen, China 518000

The product to which this declaration relates is in conformity with the essential requirements set out in the Council Directive on the Approximation of the laws of the Member States relating to the Radio Equipment Directive (2014/53/EU), the Restriction of Hazardous Substances Directive (2011/65/EU), the Electromagnetic Compatibility Directive (2014/30/EU), and the Low Voltage Directive (2014/35/EU). The product is responsible for affixing the CE marking, and the following standards were applied:

EN 55032:2015/A1:2020
EN 55035:2017/A11:2020
EN IEC 61000-3-2:2019/A2:2024
EN 61000-3-3:2013/A2:2021

ETSI EN 301 489-1 V2.2.3 (2019-11)
ETSI EN 301 489-17 V3.2.4 (2020-09)
ETSI EN 300 328 V2.2.2 (2019-07)
EN IEC 62311:2020
EN IEC 62368-1:2020+A11:2020

Full Name: Yoyo.Yu
Position: Approval Manager
Signature: 
Place/Date: Shenzhen, China / March 10, 2026