

ULTIMEA

 Dolby Atmos

 **HDMI**TM
HIGH DEFINITION MULTIMEDIA INTERFACE

 Bluetooth[®]



User Manual

Apollo S60

EN: User Manual

DE: Benutzerhandbuch

JP: ユーザーマニュアル

FR: Manuel de l'Utilisateur

IT: Manuale d'uso

ES: Manual del usuario

Model No.: U3620

Apollo S60 4.1 Channel Dolby Atmos Detachable Soundbar

Contents

01	User Manual	English
	Connection and Installation	02
07	Benutzerhandbuch	Deutsch
	Anschluss und Installation	08
13	ユーザーマニュアル	日本語
	接続と設置	14
19	Mode d'Emploi	Français
	Raccordement et installation	20
25	Manuale d'uso	Italiano
	Connessione e installazione	26
31	Manual del usuario	Español
	Conexión e instalación	32

User Manual

WE ARE
READY
TO HELP



support@ultimea.com



Model No.: U3620

Prefer video tutorial?

Setup guidance video, USER MANUAL or Trouble Shooting on ULTIMEA website.

@ultimea_official



support.ultimea.com

+1 888-598-8875 (US) Mon-Fri 9am-5pm (PST)
 +49 89-628-25828 (EU) Mon-Fri 9am-5pm (CET)

1 ACCESSORIES LIST



Soundbar

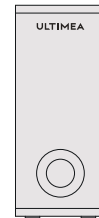

Subwoofer

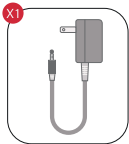

Power Adaptor

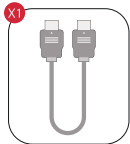

HDMI Cable

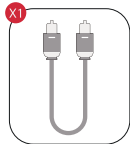

Digital Optical Cable

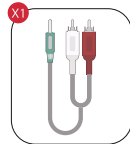

Stereo RCA to 3.5mm Audio Cable

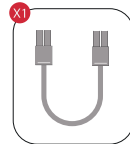

4-pin Cable for Soundbar Connection(100mm)

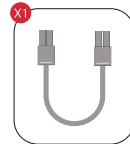

4-pin Cable for Soundbar Connection(2.5m)

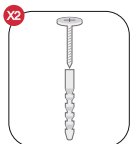

Wall Mounting Kit

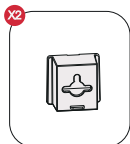

Wall Bracket



Remote Control

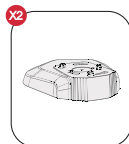

Base



User Manual

2 SOUNDBAR CONTROLS

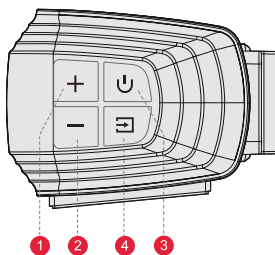

Control Panel

- 1 **VOL+**: Volume Up.
- 2 **VOL-**: Volume Down.
- 3 **Power Button**: Press to power button to turn on / off
- 4 **INPUT**: Press to switch channels: eARC-HDIN-OPT(OPTICAL)-BT-AUX-USB. Hold for 3 seconds to disconnect the current device and connect to a new device manually on your mobile phone / PC / TV (BT ID: Apollo S60)

Remote Control

- 1 "⏻": **Power Button**
Press to power button to turn on / off.
- 2 "eARC": **eARC**
Press to switch to HDMI eARC channel.
- 3 "HD IN": **HDIN**
Press to switch to HDMI IN channel.
- 4 "OPT": **OPT**
Press to switch to OPTICAL channel.
- 5 "AUX": **AUX**
Press to switch to AUX channel.
- 6 "BT": **BT**
Press to switch to Bluetooth channel and enter pairing mode.
Hold for 3 seconds to disconnect current device and connect to a new device manually on your mobile phone / PC / TV (BT ID: Apollo S60).
- 7 "USB": **USB**
Press to switch to USB channel.
- 8 "+": **Volume Up**
- 9 "-": **Volume Down**
- 10 "<": **Previous**
For BT and USB mode only: Skip to previous track.
- 11 ">": **Next**
For BT and USB mode only: Skip to next track.
- 12 "▶||": **Play / Pause**
For BT and USB mode only.
USB mode: Hold for 3 seconds to switch between single loop playback and list loop playback.
- 13 "MOVIE": **MOVIE**
Press to switch to MOVIE mode.
- 14 "GAME": **GAME**
Press to switch to GAME mode.
- 15 "MUSIC": **MUSIC**
Press to switch to MUSIC mode.
- 16 "BASS MAX": **BASSMAX**
Press to adjust bass level, the display will show: "b5-2", "b5-1", "b5 0", "b5 1", "b5 2".
- 17 "🔇": **Mute / Recover the volume.**

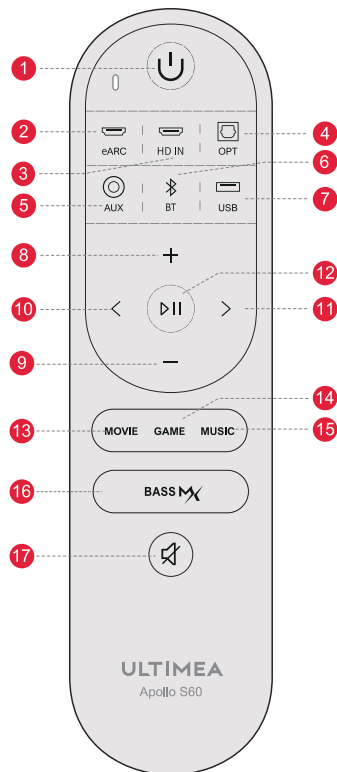

3 SOUNDBAR INSTALLATION

Assembly steps:

- 1 Align the joints of the two parts.

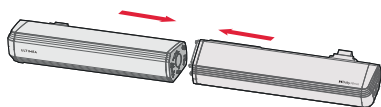

- 2 Twist to connect.

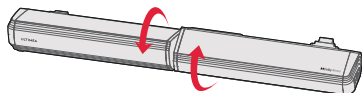

- 3 Plug in the 4-pin Cable for Soundbar Connection.

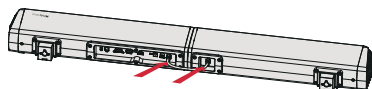

Detached and stand on base:

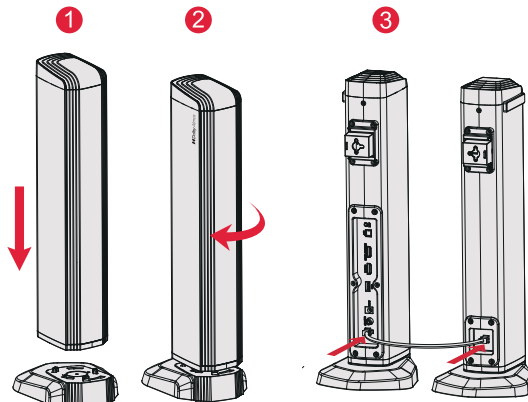

- 1 Set the soundbar on the base and align the joints.
- 2 Twist to connect with the base.
- 3 Plug in the 4-pin Cable for Soundbar Connection.

4 CONNECT TO SUBWOOFER

EN

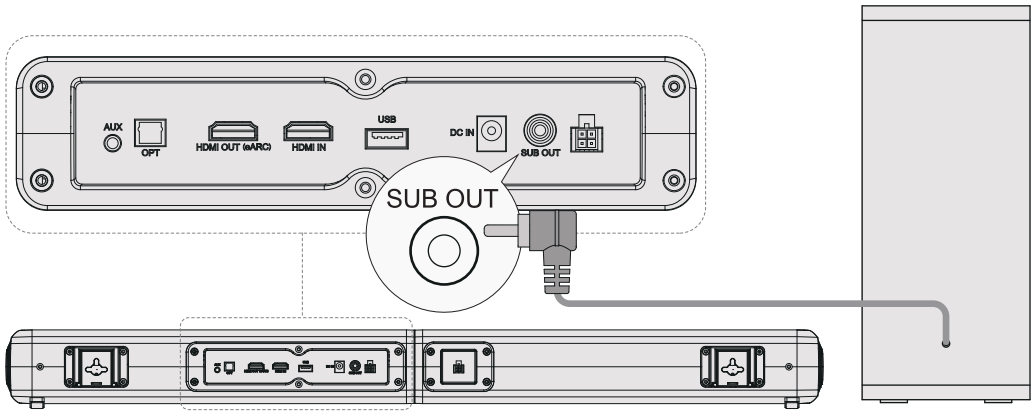

5 CONNECT TO TV VIA HDMI OUT eARC / ARC

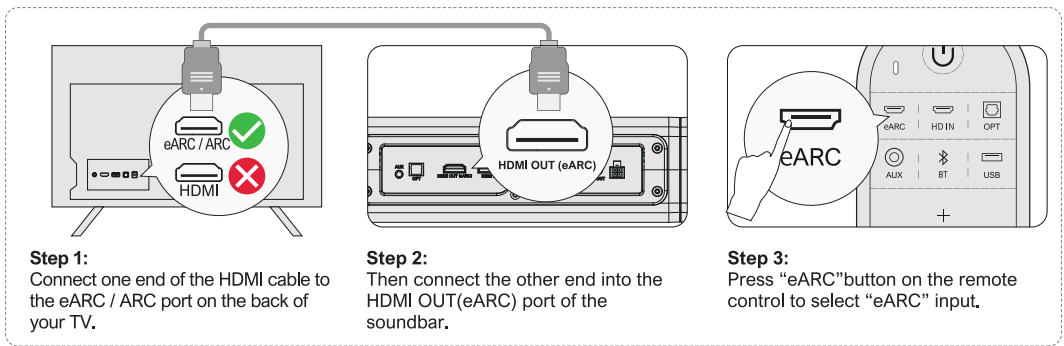

6 CONNECT TO OTHER DEVICE VIA HDMI IN

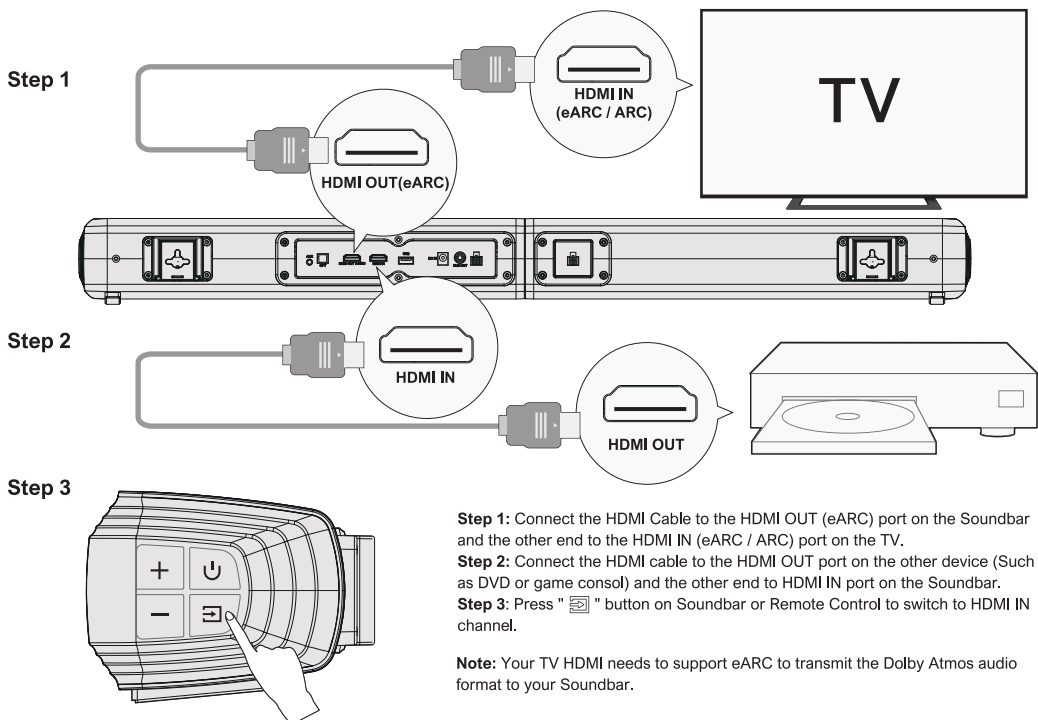

Note:

Make sure your TV HDMI supports eARC, otherwise the Dolby Atmos audio signal cannot be transmitted.

Atmos: If you are watching movie in the Dolby Atmos format, please set the audio output on your TV to Pass Through:
TV Settings > Home > Settings > Sound > Digital Audio Output > Pass Through

DTS: If you are watching a movie in the DTS format, please set the audio output on your TV to PCM:
TV Settings > Home > Settings > Sound > Digital Audio Output > PCM

What's the difference between: HDMI IN, HDMI ARC, HDMI eARC?

HDMI IN is a standard HDMI input that allows you to connect devices to your TV or audio system. It supports audio and video signals, but it does not support audio return channel (ARC) or enhanced audio return channel (eARC) functionality.

HDMI ARC is a special HDMI port that supports two-way communication between your TV and audio system. This means that audio can be sent from your TV to your audio system, and audio system can send audio back to your TV.

HDMI eARC (Enhanced Audio Return Channel) is an updated version of HDMI ARC that supports higher quality audio formats such as Dolby Atmos and DTS:X.

Note: Please turn on the "CEC" function on your TV.

When eARC / ARC is connected, your TV remote control can control the soundbar and TV simultaneously:

- ① Turn on / off
- ② Adjust the volume

7 CONNECT TO TV VIA OPTICAL / AUX

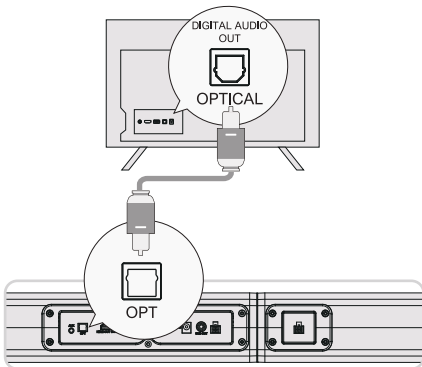
OPTICAL**OPTION 1: OPTICAL**

- ① Make sure the TV's port is OPTICAL OUT, connect both sides of the cable to OPTICAL, for both the TV and the soundbar.
- ② Make sure the optical plug is inserted correctly as it shows in the picture. Do not insert the plug upside down and break the optical.

Note: If audio is coming from the internal TV speakers, mute or minimize the TV volume.

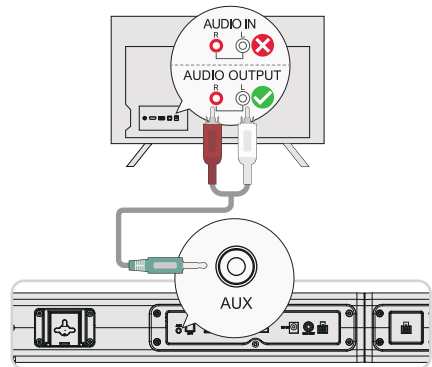
AUX**OPTION 2: AUX**

- ① Connect the 3.5mm to RCA audio cable to connect to your TV's RCA AUDIO OUTPUT port.
- ② Make sure the color of the cables ends matches the color of the TV ports.

Note: Please remember to unplug the AUX cable from TV and Soundbar when you want to switch other mode.

In Optical Mode: If there is no sound, try setting the TV audio output to PCM: TV Settings > Home > Settings > Sound > Digital Audio Output > PCM

8 CONNECT TO BLUETOOTH®

- ① Press the "⏻" button on the soundbar or press the "🔗" button on the remote control to enter Bluetooth pairing mode.
- ② Go to the Bluetooth setting on your phone, find and select "Apollo S60" to connect the soundbar.

Note: If it's already in the Bluetooth mode and connected, press and hold "🔗" button for 3 seconds to disconnect current device and choose to connect to a new device manually on your mobile phone / PC / TV.

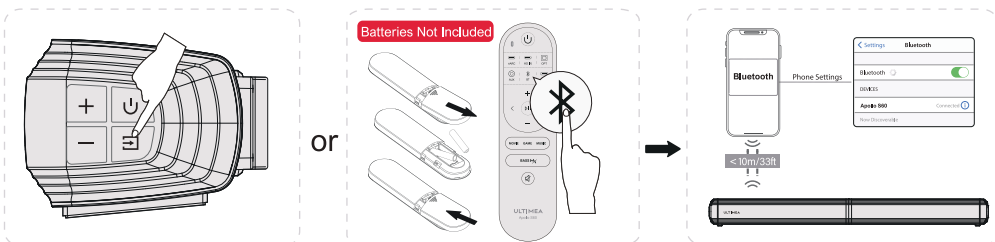

Detached and stand on base

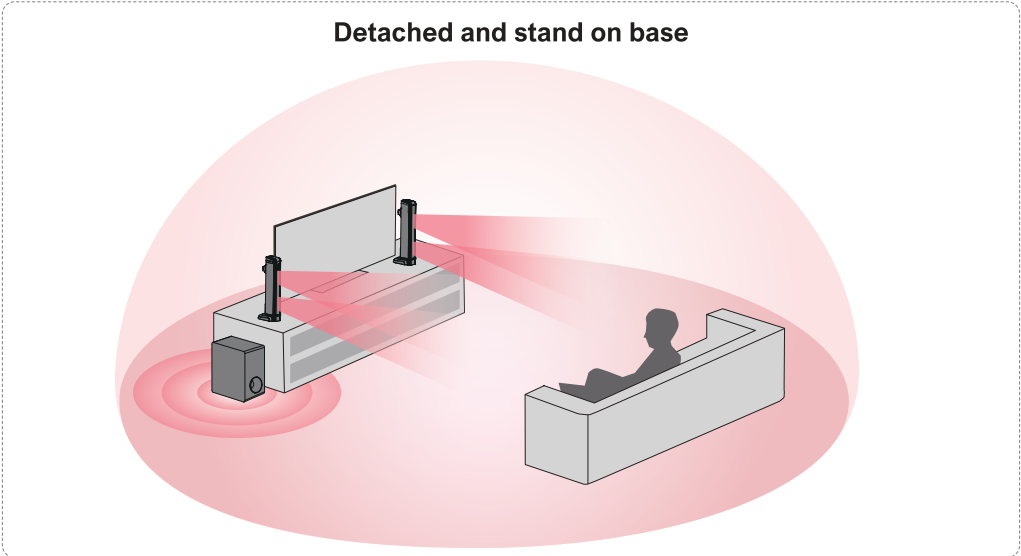

Horizontal placement

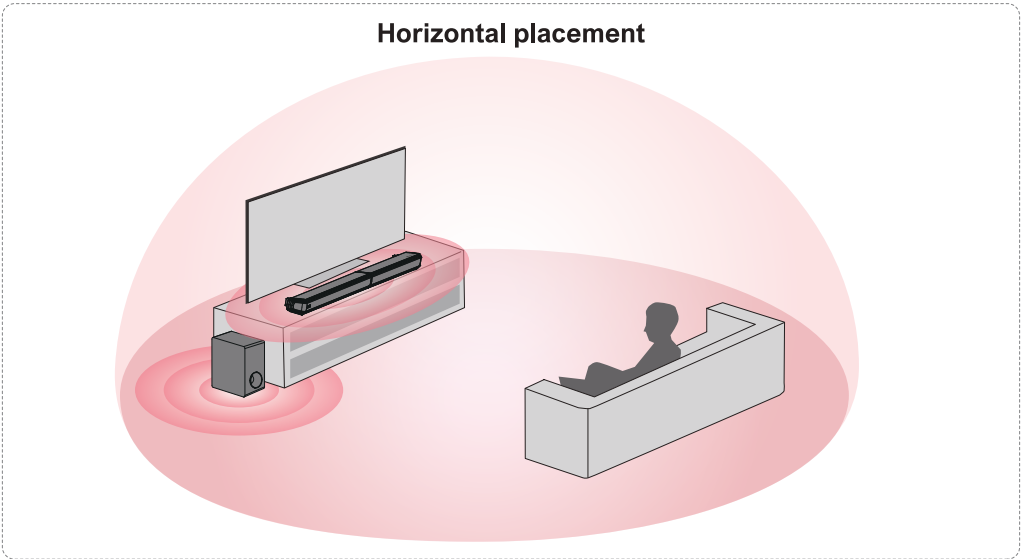

Note: The soundbar should be placed at or near ear level.

10 WALL MOUNT INSTALLATION

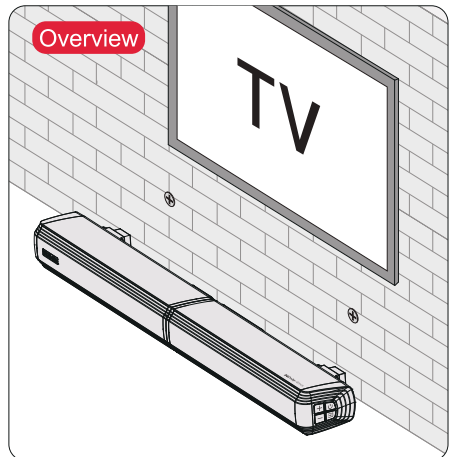
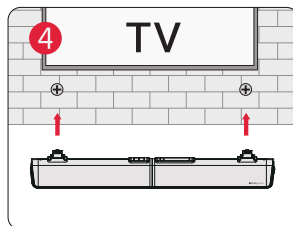
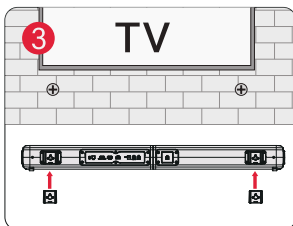
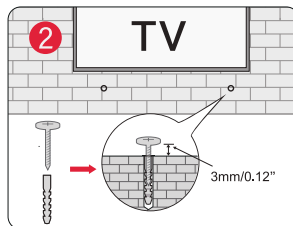
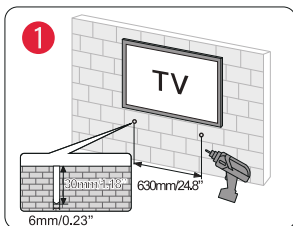

Model Number	U3620
Power Supply	AC 100-240V, ~50/60Hz
Soundbar Drivers	2.25" x 4 (Soundbar) + 5.25" (Subwoofer)
Frequency Response	45Hz - 18kHz
Standby Power	<0.5W
Operating Temperature	0°C - 45°C/32°F - 113°F
Bluetooth Vision	5.3

Dimensions and Weight		
Soundbar	811(W) × 98(D) × 70(H)	31.9" x 3.9" x 2.8"
Subwoofer	270(W) × 115(D) × 270(H)	10.6" x 4.5" x 10.6"
Packaging	436(W) × 306(D) × 236(H)	17.2" x 12.15" x 9.3"
Net Weight	4.6kg / 10.14lbs	
Gross Weight	6.7kg / 14.77lbs	

ULTIMEA

Apollo S60

Benutzerhandbuch



Modell Nr.: U3620

WIR SIND BEREIT ZU HELFEN



support@ultimea.com

DE

Bevorzugen Sie ein Video-Tutorial?

Video-Anleitung, HANDBUCH
oder Fehlerbehebung auf der
ULTIMEA Website.

@ultimea_official



support.ultimea.com

+1 888-598-8875 (US) Mon-Fri 9am-5pm (PST)
+49 89-628-25828 (EU) Mon-Fri 9am-5pm (CET)

1 ZUBEHÖRLISTE

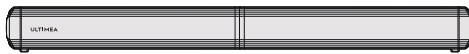

Soundbar

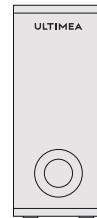

Subwoofer

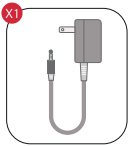

Netzadapter



HDMI-Kabel

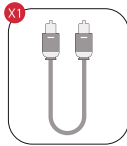

Optisches Digitalkabel

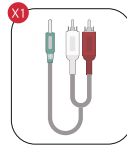

Stereo 3,5mm auf
RCA Audiokabel

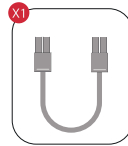

4-poliges Kabel für
Soundbar-Anschluss
(100 mm)

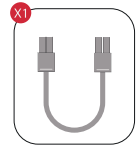

4-poliges Kabel für
Soundbar-Anschluss
(2,5m)



Wandmontage-Kit

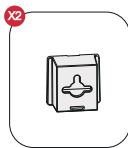

Wandhalterung



Fernbedienung

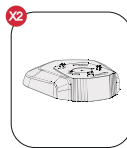

Socket



Benutzerhandbuch

2 SOUNDBAR-STEUERUNG

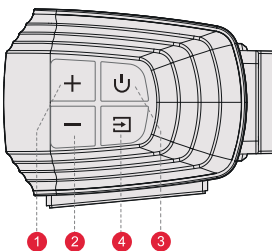

Bedienfeld

- 1 **VOL+:** Lautstärke erhöhen
- 2 **VOL-:** Lautstärke verringern
- 3 **Power-Taste:**
Drücken Sie die Ein-/Aus-Taste zum Ein-/Ausschalten
- 4 **QUELLE:**
Drücken, um den Kanal zu wechseln: eARC-OPT(OP-TISCH)-BT-AUX-USB.
Halten Sie die Taste 3 Sekunden lang gedrückt, um die Verbindung zum aktuellen Gerät zu trennen und manuell eine Verbindung zu einem neuen Gerät auf Ihrem Mobiltelefon/P-C/Fernseher herzustellen (BT-ID: Apollo S60).

Fernsteuerung

- 1 "U": **Einschalttaste**
Zum Einschalten drücken / zum Ausschalten.
- 2 "eARC": **eARC**
Drücken Sie diese Taste, um zum HDMI eARC-Kanal zu wechseln.
- 3 "HD IN": **HD IN**
Drücken Sie diese Taste, um zum HDMI IN-Kanal zu wechseln.
- 4 "OPT": **OPT**
Drücken Sie diese Taste, um zum OPTICAL-Kanal zu wechseln.
- 5 "AUX": **AUX**
Drücken Sie diese Taste, um zum AUX-Kanal zu wechseln.
- 6 "BT": **BT**
Drücken Sie diese Taste, um zum Bluetooth-Kanal zu wechseln und den Kopplungsmodus zu aktivieren.
Halten Sie die Taste 3 Sekunden lang gedrückt, um die Verbindung zum aktuellen Gerät zu trennen und manuell eine Verbindung zu einem neuen Gerät auf Ihrem Mobiltelefon / PC / TV herzustellen (BT-ID: Apollo S60).
- 7 "USB": **USB**
Drücken Sie diese Taste, um zum USB-Kanal zu wechseln.
- 8 "+": **Lautstärke erhöhen**
- 9 "-": **Lautstärke verringern**
- 10 "<": **Zurück**
Nur im BT- und USB-Modus: Zum vorherigen Titel springen.
- 11 ">": **Weiter**
Nur für den BT- und USB-Modus: Zum nächsten Titel springen.
- 12 "DII": **Abspielen / Pause**
Nur für den BT- und USB-Modus.
USB-Modus: 3 Sekunden lang gedrückt halten, um zwischen Einzel- und Listenschleifenwiedergabe umzuschalten.
- 13 "MOVIE": **FILM**
Drücken Sie diese Taste, um in den FILM-Modus zu wechseln.
- 14 "GAME": **GAME**
Drücken Sie, um in den GAME-Modus zu wechseln.
- 15 "MUSIC": **MUSIC**
Drücken Sie, um in den MUSIC-Modus zu wechseln.
- 16 "BASS MAX": **BASSMAX**
Drücken Sie diese Taste, um den Basspegel einzustellen; auf dem Display wird angezeigt: "b5-2", "b5-1", "b5 0", "b5 1", "b5 2".
- 17 "Mute": **Stummschaltung / Lautstärke wiederherstellen**

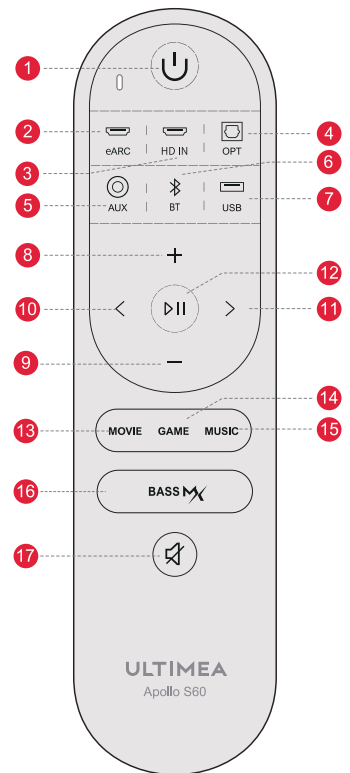

3 SOUNDBAR-INSTALLATION

Montageschritte:

- 1 Richten Sie die Verbindungen der beiden Teile aus.

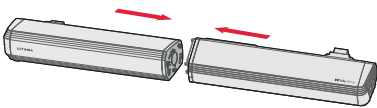

- 2 Zum Verbinden verdrehen.

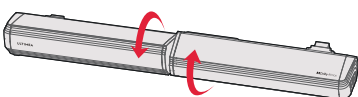

- 3 Stecken Sie das 4-polige Kabel für den Soundbar-Anschluss ein.

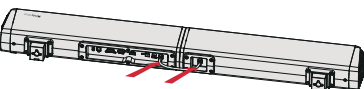

Abnehmen und auf den Sockel stellen:

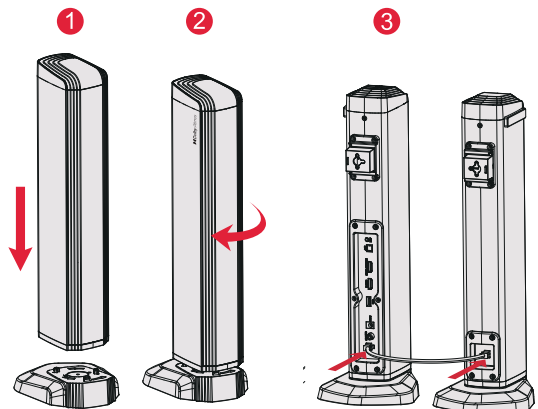

- 1 Setzen Sie die Soundbar auf den Sockel und richten Sie die Gelenke aus.
- 2 Drehen Sie sie, um sie mit dem Sockel zu verbinden.
- 3 Stecken Sie das 4-polige Kabel für den Soundbar-Anschluss ein.

4 ANSCHLUSS AN SUBWOOFER

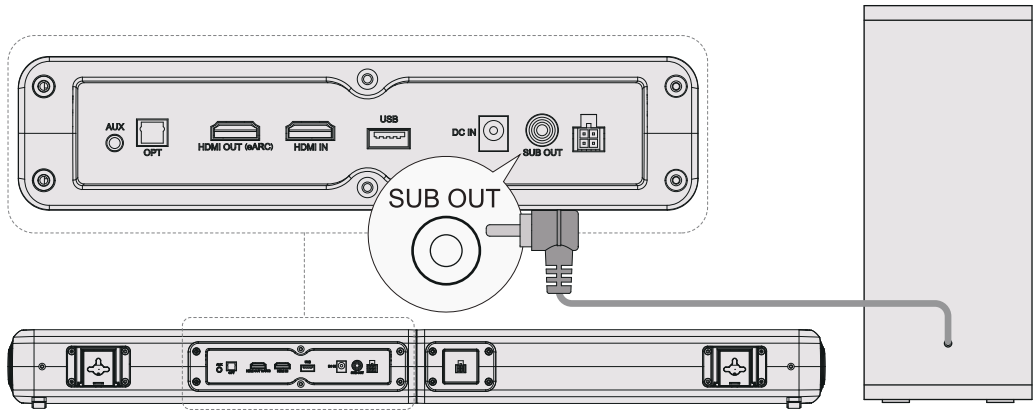

DE

5 ANSCHLUSS AN FERNSEHER ÜBER ARC

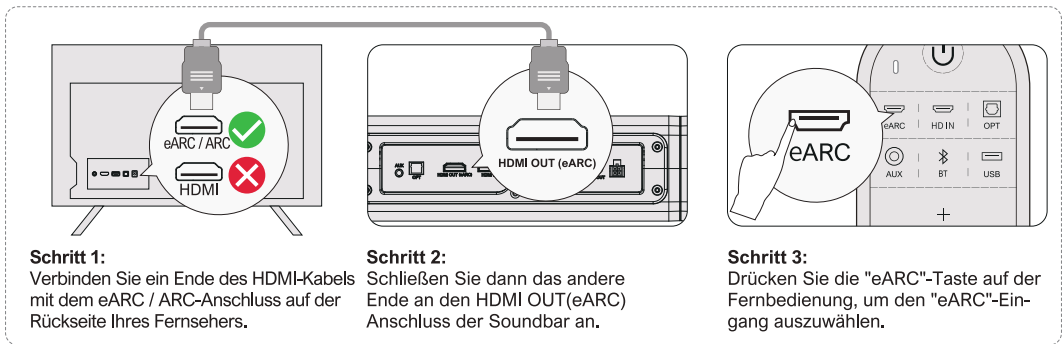

Schritt 1:

Verbinden Sie ein Ende des HDMI-Kabels mit dem eARC / ARC-Anschluss auf der Rückseite Ihres Fernsehers.

Schritt 2:

Schließen Sie dann das andere Ende an den HDMI OUT (eARC) Anschluss der Soundbar an.

Schritt 3:

Drücken Sie die "eARC"-Taste auf der Fernbedienung, um den "eARC"-Eingang auszuwählen.

6 ANSCHLUSS AN EIN ANDERES GERÄT ÜBER HDMI IN

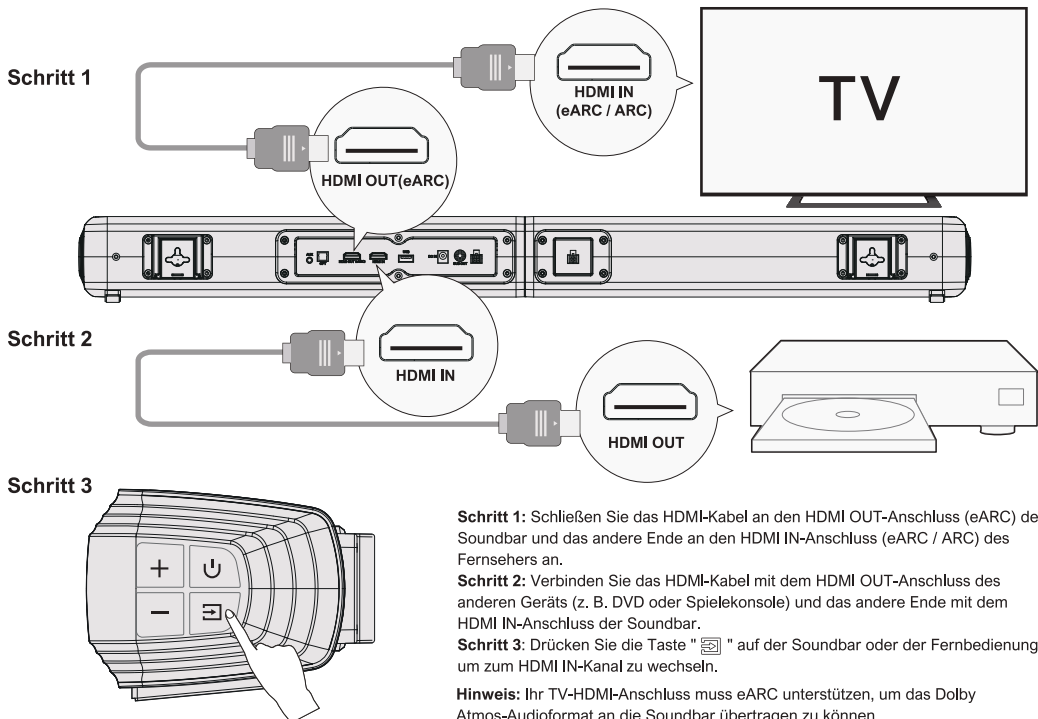

Schritt 1

Schritt 2

Schritt 3

Schritt 1: Schließen Sie das HDMI-Kabel an den HDMI OUT-Anschluss (eARC) der Soundbar und das andere Ende an den HDMI IN-Anschluss (eARC / ARC) des Fernsehers an.

Schritt 2: Verbinden Sie das HDMI-Kabel mit dem HDMI OUT-Anschluss des anderen Geräts (z. B. DVD oder Spielekonsole) und das andere Ende mit dem HDMI IN-Anschluss der Soundbar.

Schritt 3: Drücken Sie die Taste "HDMI IN" auf der Soundbar oder der Fernbedienung, um zum HDMI IN-Kanal zu wechseln.

Hinweis: Ihr TV-HDMI-Anschluss muss eARC unterstützen, um das Dolby Atmos-Audioformat an die Soundbar übertragen zu können.

Anmerkung:

Vergewissern Sie sich, dass Ihr Fernsehgerät eARC unterstützt, sonst kann das Dolby Atmos-Audiosignal nicht übertragen werden.

Atmos: Wenn Sie einen Film im Dolby Atmos-Format ansehen, stellen Sie bitte die Audioausgabe Ihres Fernsehers auf "Durchlassen" ein:

TV-Einstellungen > Startseite > Einstellungen > Ton > Digitaler Audioausgang > Pass Through

DTS: Wenn Sie sich einen Film im DTS-Format ansehen, stellen Sie den Audioausgang an Ihrem Fernsehgerät auf PCM ein:
TV-Einstellungen > Startseite > Einstellungen > Ton > Digitaler Audioausgang > PCM

Was ist der Unterschied zwischen: HDMI IN, HDMI ARC, HDMI eARC?

HDMI IN ist ein standardmäßiger HDMI-Eingang, über den Sie Geräte an Ihren Fernseher oder Ihr Audiosystem anschließen können. Er unterstützt Audio- und Er unterstützt Audio- und Videosignale, nicht aber den Audio-Rückkanal (ARC) oder den erweiterten Audio-Rückkanal (eARC).

HDMI ARC ist ein spezieller HDMI-Anschluss, der die Zwei-Wege-Kommunikation zwischen Ihrem Fernsehgerät und Ihrem Audiosystem unterstützt. Das bedeutet, dass Audiosignale von Ihrem Fernsehgerät an Ihr Audiosystem gesendet werden können und das Audiosystem Audiosignale an Ihr Fernsehgerät zurücksenden kann.

HDMI eARC (Enhanced Audio Return Channel) ist eine aktualisierte Version von HDMI ARC, die Audioformate in höherer Qualität unterstützt wie Dolby Atmos und DTS:X.

Hinweis: Bitte schalten Sie die Funktion "CEC" an Ihrem Fernseher ein.

Wenn eARC / ARC angeschlossen ist, kann Ihre TV-Fernbedienung die Soundbar und den Fernseher gleichzeitig steuern:

- ❶ Einschalten / Ausschalten ❷ Lautstärke einstellen

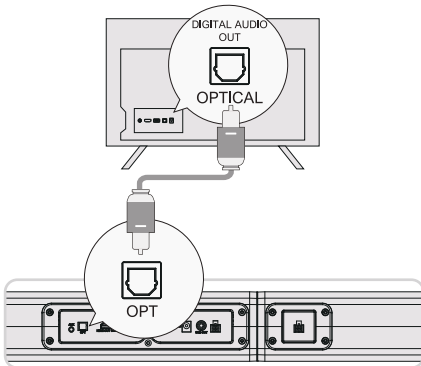
7 ANSCHLUSS AN FERNSEHER ÜBER OPTISCH / AUX**OPTISCH****OPTION 1: OPTISCH**

- ❶ Vergewissern Sie sich, dass der Anschluss des Fernsehers auf OPTICAL OUT eingestellt ist, und verbinden Sie beide Seiten des OPTICAL-Kabels, sowohl für den Fernseher als auch für die Soundbar.
- ❷ Vergewissern Sie sich, dass der optische Stecker richtig eingesteckt ist, wie auf dem Bild zu sehen. Stecken Sie den Stecker nicht verkehrt herum ein, um das optische Kabel nicht zu beschädigen.

Hinweis: Wenn der Ton aus den internen TV-Lautsprechern kommt, schalten Sie die TV-Lautstärke stumm oder minimieren Sie sie.

Im optischen Modus: Wenn kein Ton zu hören ist, versuchen Sie, den Audioausgang des Fernsehers auf PCM einzustellen:
TV-Einstellungen > Startseite > Einstellungen > Ton > Digitaler Audioausgang > PCM

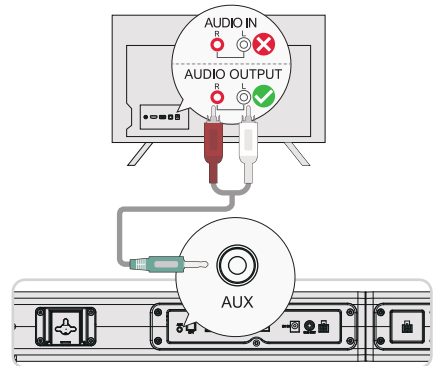
AUX**OPTION 2: AUX**

- ❶ Schließen Sie das 3,5mm RCA-Audiokabel an den RCA-Audioausgang Ihres Fernsehers an.
- ❷ Achten Sie darauf, dass die Farbe der Kabelenden mit der Farbe des TV-Anschlusses übereinstimmt.

Hinweis: Bitte denken Sie daran, das AUX-Kabel vom Fernseher und der Soundbar zu trennen, wenn Sie in einen anderen Modus wechseln möchten.

8 VERBINDEN MIT BLUETOOTH®

- ❶ Drücken Sie die Taste "☰" auf der Soundbar oder die Taste "⌘" auf der Fernbedienung, um den Bluetooth-Kopplungsmodus zu aktivieren.
- ❷ Öffnen Sie die Bluetooth-Einstellungen auf Ihrem Handy, suchen Sie nach "Apollo S60" und wählen Sie es aus, um eine Verbindung mit der Soundbar herzustellen

Hinweis: Wenn es sich bereits im Bluetooth-Modus befindet und eine Verbindung besteht, halten Sie die Taste "⌘" 3 Sekunden lang gedrückt, um das aktuelle Gerät zu trennen und die Verbindung zu einem neuen Gerät manuell auf Ihrem Mobiltelefon / PC / Fernseher herzustellen.

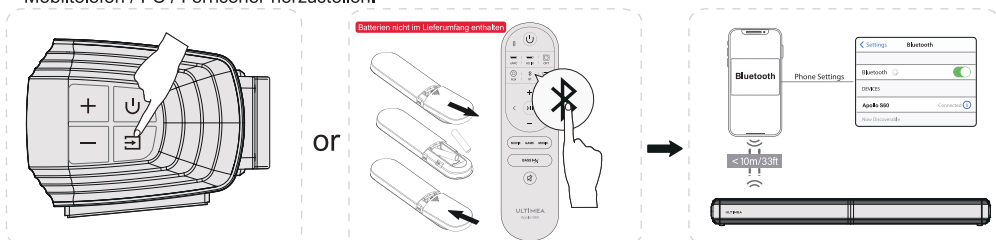

Abnehmen und auf Sockel stehend

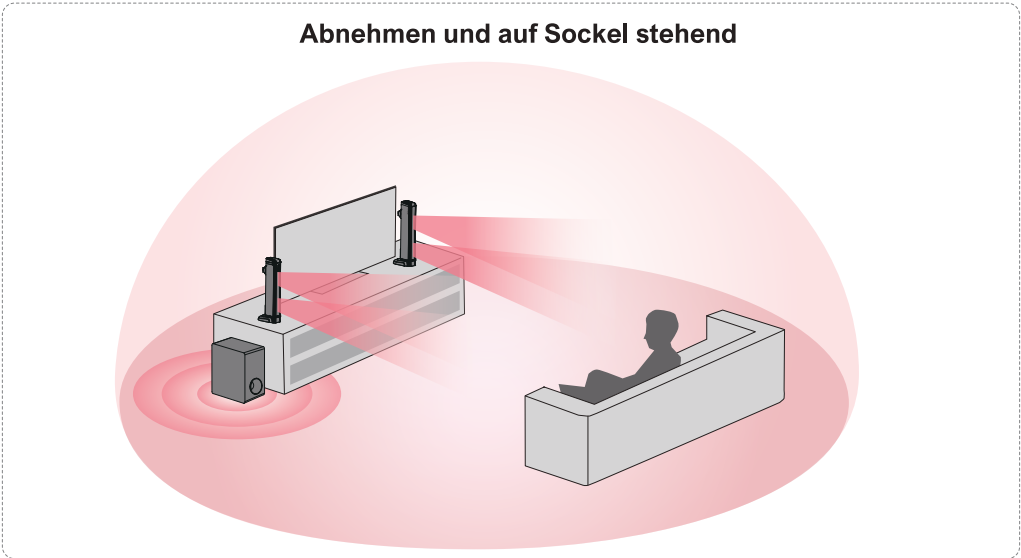

Horizontale Aufstellung

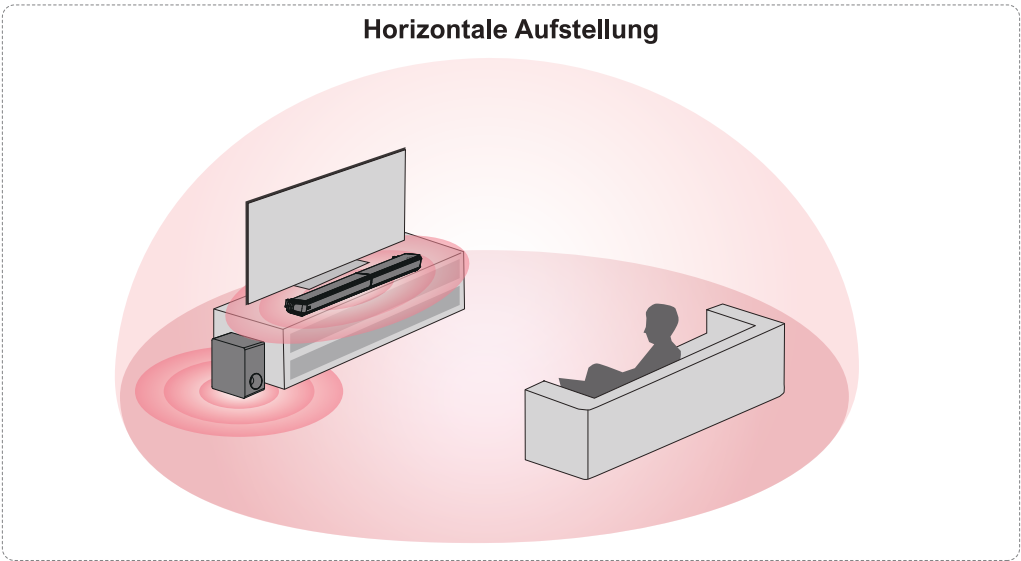

Hinweis: Die Soundbar sollte in Ohrhöhe oder in der Nähe des Ohres aufgestellt werden.

10 WANDMONTAGE

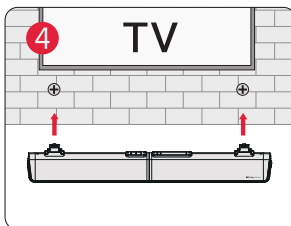
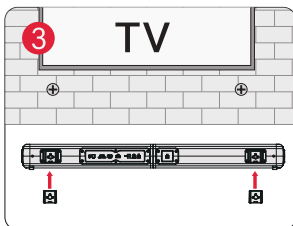
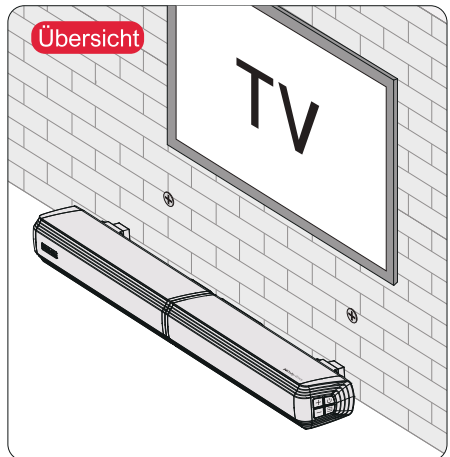
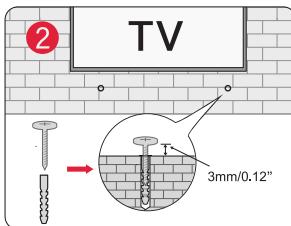
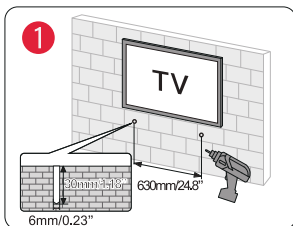

Modell Nummer	U3620
Stromversorgung	AC 100-240V, ~50/60Hz
Soundbar-Treiber	2.25" x 4 (Soundbar) + 5.25" (Subwoofer)
Frequenzgang	45Hz - 18kHz
Standby-Leistung	<0,5W
Betriebstemperatur	0°C - 45°C/32°F - 113°F
Bluetooth-Version	5.3

Abmessung und Gewicht		
Soundbar	811(W) × 98(D) × 70(H)	31.9" x 3.9" x 2.8"
Subwoofer	270(W) × 115(D) × 27(H)	10.6" x 4.5" x 10.6"
Verpackung	436(W) × 306(D) × 236(H)	17.2" x 12.15" x 9.3"
Nettogewicht	4.6kg / 10.14lbs	
Bruttogewicht	6.7kg / 14.77lbs	

ULTIMEA

Apollo S60

ユーザー取扱説明書

うちにご支援
させていただ
く準備が整い
ております



support@ultimea.com

JP



モデル番号: U3620

ビデオチュートリアル
をご希望ですか？

設定方法のビデオ、或いは
ULTIMEAホームページの取扱
説明書をご参照ください。

@ultimea_official



support.ultimea.com

+1 888-598-8875 (US) Mon-Fri 9am-5pm (PST)
 +49 89-628-25828 (EU) Mon-Fri 9am-5pm (CET)

1 付属品リスト



サウンドバー

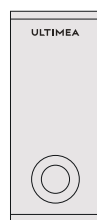

サブウーファー

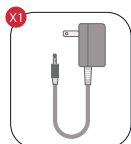

電源アダプター

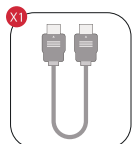

HDMIケーブル

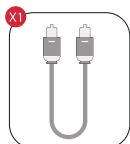

光デジタルケーブル

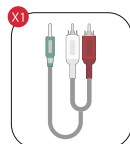

3.5mm-RCAオーディオケーブル

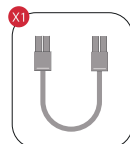

4-pin サウンドバー
接続用ケーブル(100mm)

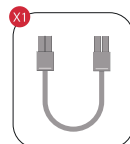

4-pin サウンドバー
接続用ケーブル(2.5M)

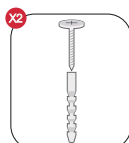

壁掛けネジキット

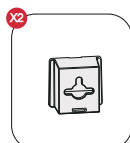

壁掛け固定スタンド



リモコン

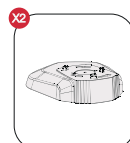

固定用ベース



ユーザーマニュアル

2 サウンドバーコントロール

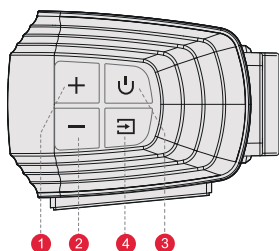

コントロールパネル

- ① VOL+: ボリュームアップ
- ② VOL-: ボリュームダウン
- ③ 電源ボタン:
電源ボタンを押すとオン/オフになります
- ④ 入力ソース:

押してチャンネルを切り替える: earc-opt(optcal)-bt-aux-usb
3秒間長押しすると、現在のデバイスが切断され、スマホ/PC/TV
(BT ID: Apollo S60) の新しいデバイスに手動で接続されます。

リモコン

- 1 “**U**”: 電源ボタン
電源ボタンを押すとオン/オフになります。
- 2 “**eARC**”: ARC
押すとHDMI/ARCに切り替えます。
- 3 “**HD IN**”: HD IN
押すとHDMI IN チャンネルに切り替えます。
- 4 “**OPT**”: OPT
押すとOPTICALに切り替えます。
- 5 “**AUX**”: AUX
押すとAUXに切り替えます。
- 6 “**BT**”: BT
押すとBluetoothに切り替え、ペアリングモードに入ります。
3秒間長押しすると、現在のデバイスが切断され、携帯電話/PC/TV
(BT ID: Apollo S60)で新しいデバイスに手動で接続されます。
- 7 “**USB**”: USB
押すとUSBに切り替わります。
- 8 “**+**”: ボリュームアップ
- 9 “**-**”: ボリュームダウン
- 10 “**<**”: 前
BTおよびUSBモードのみ 前のトラックにスキップする。
- 11 “**>**”: 次へ
BTおよびUSBモードのみ: 次のトラックにスキップします。
- 12 “**▶||**”: 再生 / 一時停止
BTおよびUSBモードのみ
USBモード: 3秒間長押しすると、単一曲循環再生とリスト循環再生
が切り替わります。
- 13 “**MOVIE**”: MOVIE
押すと映画モードに切り替わり: “E9 1”と表示されます。
- 14 “**GAME**”: ゲーム
押すとゲームモードに切り替わり: “E9 2”と表示されます。
- 15 “**MUSIC**”: 音楽
押すと音楽モードに切り替わり: “E9 3”と表示されます。
- 16 “**BASS MAX**”: バスマックス
押してベースの音量を調節します: “b5-2”, “b5-1”, “b5 0”, “b5 1”, “b5 2”。
- 17 “**🔇**”: 音量ミュート / リストア。

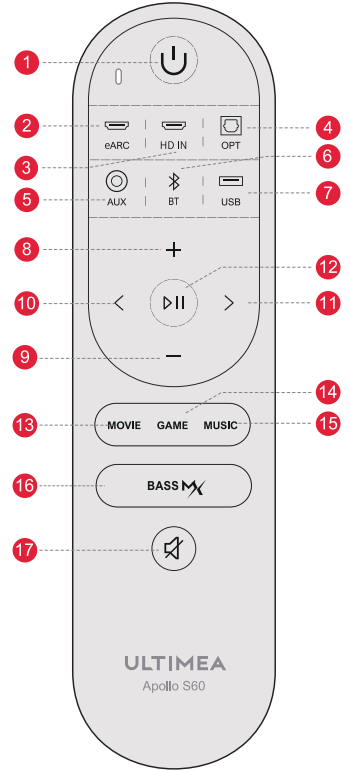

3 サウンドバーの設置

組み立ての手順:

- 1 2つのパーツの接合部を合わせます。

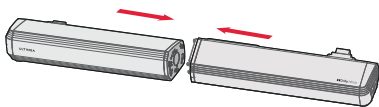

- 2 ねじって接続します。

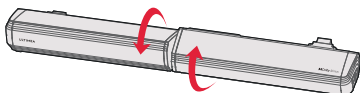

- 3 4-pinサウンドバー接続用のケーブルを差し込みます。

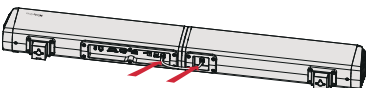

サウンドバーを取り外し、ベースの上に置きます:

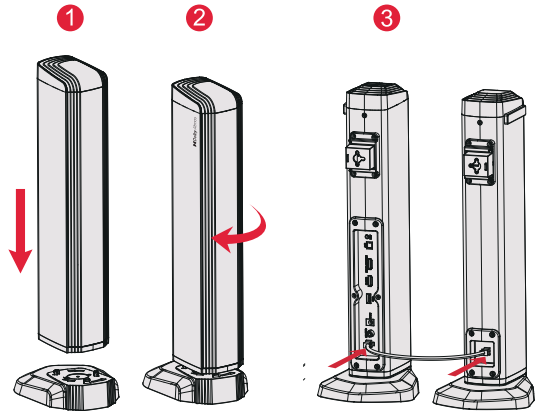

- 1 サウンドバーをベースにセットし、接合部を合わせます。
- 2 ねじってベースと接続します。
- 3 4-pinサウンドバー接続用のケーブルを差し込みます。

4 サブウーファーに接続

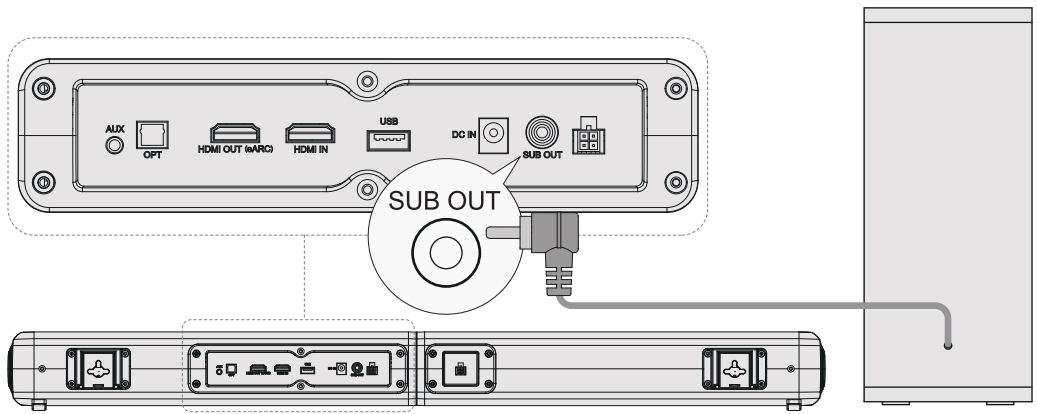

JP

5 HDMI OUT ARC でテレビに接続

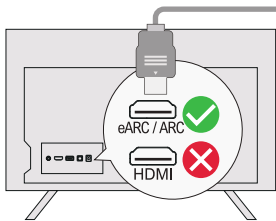

ステップ1:
HDMIケーブルの一端をテレビ背面のeARC / ARCポートに接続します。

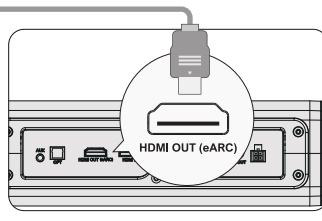

ステップ2:
もう一方の端子をサウンドバーのHDMI OUT(eARC)ポートに接続します。

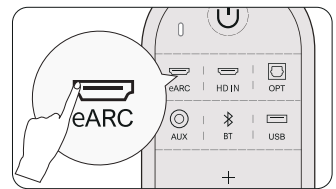

ステップ3:
リモコンの「eARC」ボタンを押して「eARC」入力を選択します。

6 HDMI入力で他の機器に接続する

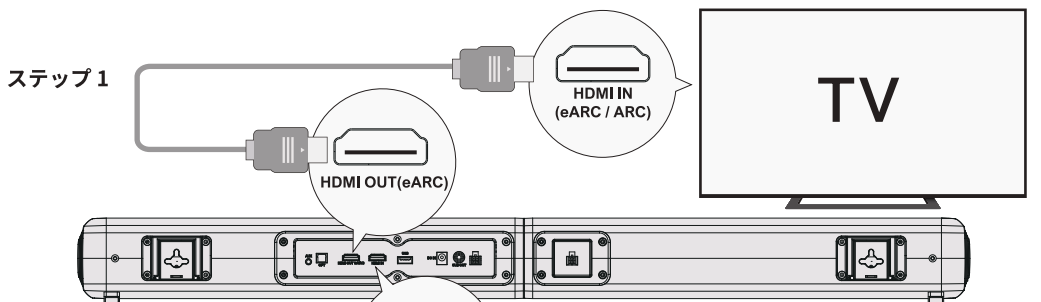

ステップ1

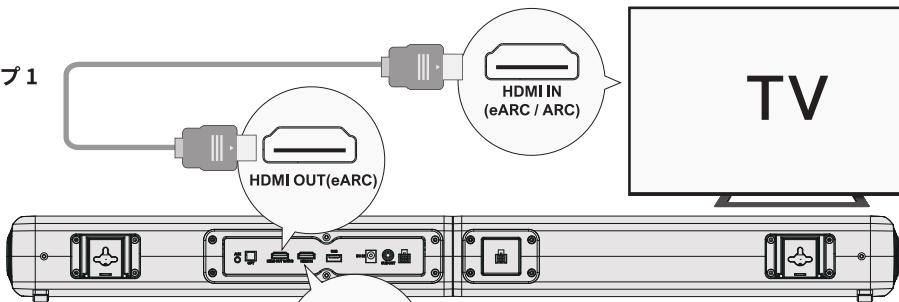

ステップ2

ステップ3

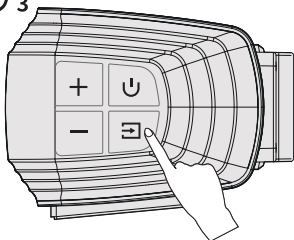

ステップ1: HDMIケーブルをサウンドバーのHDMI OUT (eARC)ポートに接続し、もう一方をテレビのeARC / ARCポートに接続します。
ステップ2: HDMIケーブルを他の機器 (DVDやゲーム機など) のHDMI OUTポートに接続し、もう一方をサウンドバーのHDMI INポートに接続します。
ステップ3: サウンドバーまたはリモコンの "HDMI IN" ボタンを押して、HDMI INチャンネルに切り替えます。

注意: Dolby Atmosオーディオ・フォーマットをサウンドバーに伝送するには、テレビのHDMIがeARCに対応している必要があります。

注意:

Dolby Atmos音声フォーマットをサウンドバーに伝送するには、テレビのHDMIポートがeARCに対応している必要があります。

Atmos: Dolby Atmosフォーマットの映画を視聴する場合は、テレビの音声出力をパススルーに設定してください:

テレビの設定 > ホーム > 設定 > サウンド > デジタル音声出力 > パススルー

DTS: DTSフォーマットの映画を視聴する場合は、テレビの音声出力をPCMに設定してください:

テレビの設定 > ホーム > 設定 > サウンド > デジタル音声出力 > PCM

HDMI IN、HDMI ARC、HDMI eARCの違いは何ですか?

HDMI IN は、テレビやオーディオシステムに機器を接続するための標準的なHDMI入力です。オーディオとビデオ信号に対応していますが、オーディオ・リターン・チャンネル (ARC) やエンハンスド・オーディオ・リターン・チャンネル (eARC) 機能には対応していません。

HDMI ARC は、テレビとオーディオシステム間の双方向通信をサポートする特別なHDMIポートです。つまり、オーディオはテレビからオーディオ・システムに送られ、オーディオ・システムはテレビにオーディオを送り返すことができます。

HDMI eARC (Enhanced Audio Return Channel) は、Dolby AtmosやDTS:Xなどの高品質オーディオフォーマットをサポートするHDMI ARCのアップデートバージョンです。

注: テレビの「CEC」機能をオンにしてください。

eARC / ARCが接続されている場合、テレビのリモコンでサウンドバーとテレビを同時に操作できます:

- ① 電源オン/オフ
- ② 音量調整

JP

7 オプティカル/AUXでテレビに接続

OPTICAL

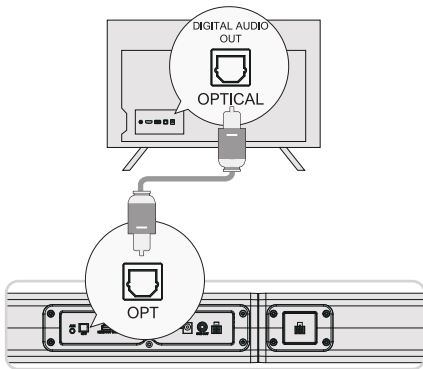

AUX

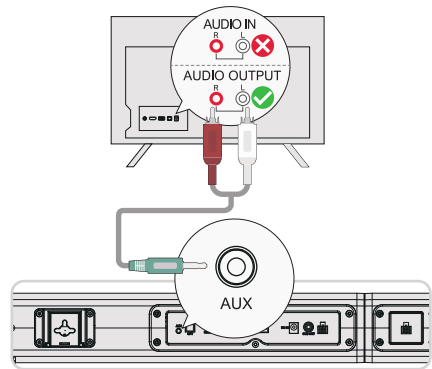

接続方法1: OPTICAL

- ① テレビのポートがOPTICAL OUTであることを確認し、ケーブルの両側をテレビとサウンドバーの両方でOPTICALに接続します。
 - ② 光デジタルケーブルが写真図のように正しく差し込んであることを確認してください。(間違っていると差し込んだ場合には、本機を損傷する恐れがあります。)
- 注: 接続した後、テレビのスピーカーからも音声が発生される場合は、テレビの音量をミュートまたは最小にしてください。

接続方法2: AUX

- ① 3.5mmオーディオケーブルをテレビのRCA AUDIO OUTポートに接続します。
 - ② ケーブルの端の色がテレビのポートの色と一致していることを確認してください。
- 注: 他のモードに切り替える場合は、テレビとサウンドバーからAUXケーブルを抜いてください。

オプティカルモード: 音が出ない場合は、テレビの音声出力をPCMに設定してください:
TV設定 > ホーム > 設定 > サウンド > デジタル音声出力 > PCM

8 Bluetoothへの接続

- ① サウンドバーの"Bluetooth"ボタンを押すか、リモコンの"Bluetooth"ボタンを押してBluetoothペアリングモードに入ります。
- ② 携帯電話のBluetooth設定に移動し、"Apollo S60"を見つけて選択し、サウンドバーを接続します。

注: もし本機と他のデバイスはBluetoothで既に接続している場合は、リモコンの"Bluetooth"ボタンを3秒間長押しして現在接続されているデバイスを切断し、お手持ちのスマートフォン/PC/TVに手動で接続してください。

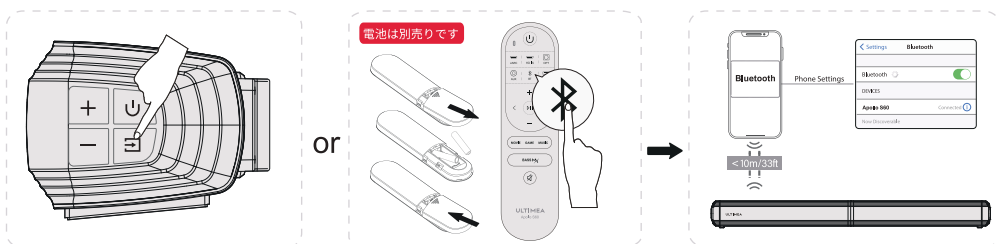

分離式サウンドバーとして、テレビの両側に置く

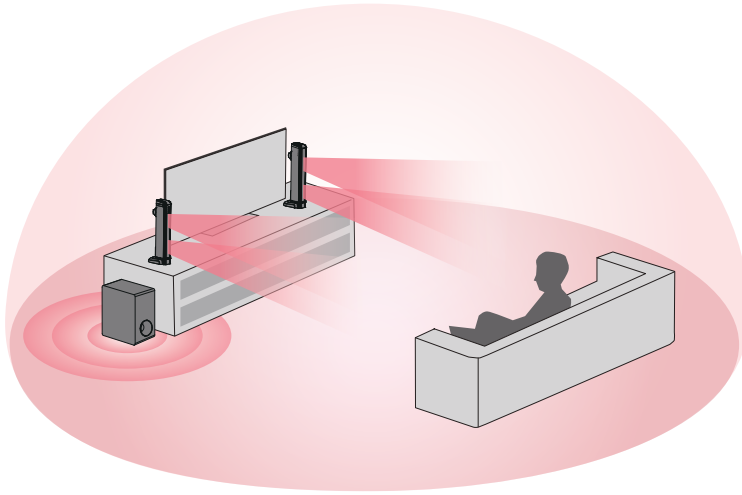

JP

一体型サウンドバーとして、テレビの下に置く

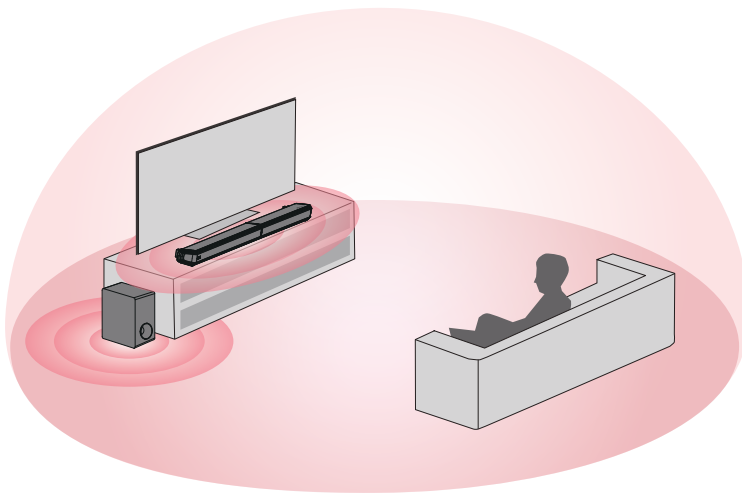

注：低音を強くするには、サブウーファーは壁や部屋の隅の近くか、いつも座っている場所の近くに置いてみてください。

10 壁掛け

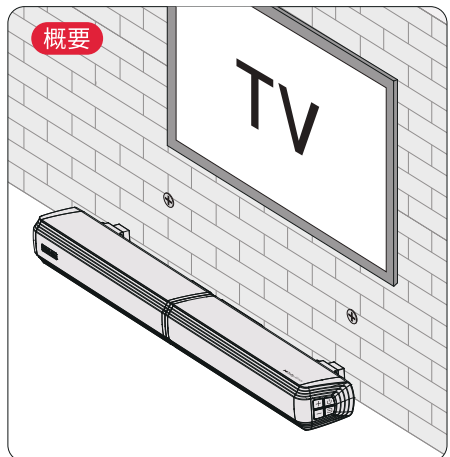
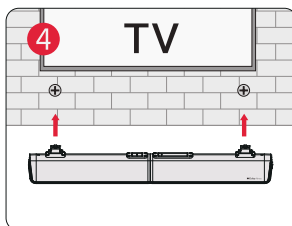
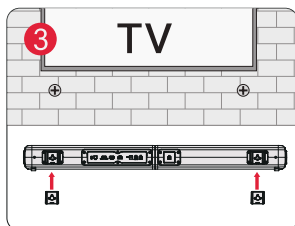
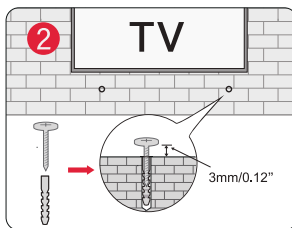
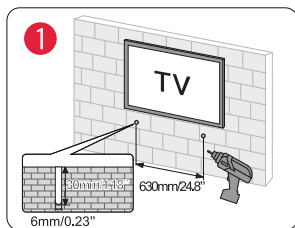

モデル番号	U3620
電源供給	AC 100-240V, ~50/60Hz
サウンドボードドライバー	2.25ch x 4 (サウンドバー) + 5.25ch(サブウーファー)
周波数帯域	45Hz - 18kHz
待機電力	<0.5W
動作温度	0°C - 45°C/32°F - 113°F
Bluetoothバージョン	5.3

寸法と重量		
サウンドバー	811(W) × 98(D) × 70(H)	31.9" x 3.9" x 2.8"
サブウーファー	270(W) × 115(D) × 27(H)	10.6" x 4.5" x 10.6"
包装	436(W) × 306(D) × 236(H)	17.2" x 12.15" x 9.3"
正味重量	4.6kg / 10.14lbs	
総重量	6.7kg / 14.77lbs	

ULTIMEA

Apollo S60

Manuel d'utilisation



Numéro de modèle: U3620

NOUS SOMMES PRÊTS À VOUS AIDER



support@ultimea.com

FR

Vous préférez un tutoriel vidéo ?

Vidéo d'aide à l'installation, ou MANUEL D'UTILISATION sur le site web d'ULTIMEA.

@ultimea_official



support.ultimea.com

+1 888-598-8875 (US) Mon-Fri 9am-5pm (PST)
+49 89-628-25828 (EU) Mon-Fri 9am-5pm (CET)

1 LISTE DES ACCESSOIRES



Barre de son

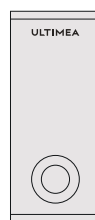

Caisson de basse

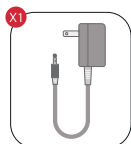

Adaptateur d'alimentation

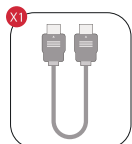

Câble HDMI

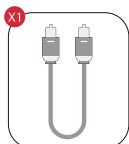

Câble optique numérique

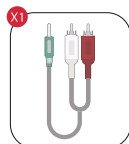

Câble audio stéréo RCA vers 3,5 mm

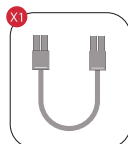

Câble à 4 broches pour la connexion de la barre de son (100mm)

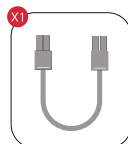

Câble à 4 broches pour la connexion de la barre de son (2,5m)

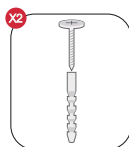

Kit de montage mural

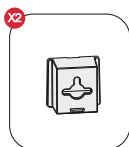

Support mural



Télécommande

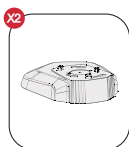

Socle

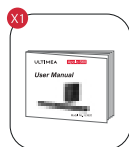

Manuel de l'utilisateur

2 COMMANDES DE LA BARRE DE SON

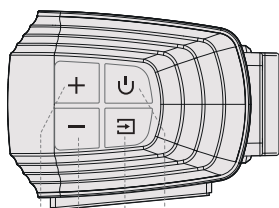

1 2 4 3

Panneau de contrôle

- 1 **VOL+**: Augmenter le volume
- 2 **VOL-**: Réduction du volume
- 3 **Bouton d'alimentation**: Appuyez sur le bouton d'alimentation pour allumer/éteindre
- 4 **SOURCE**: Appuyez sur cette touche pour changer de chaîne : eARC-OPT(OPTICAL)-BT-AUX-USB. Maintenez cette touche enfoncée pendant 3 secondes pour déconnecter l'appareil actuel et le connecter manuellement à un nouvel appareil sur votre téléphone portable / PC / TV (BT ID : Apollo S60).

Télécommande

- 1 "⏻": **Bouton d'alimentation**
Appuyez sur le bouton d'alimentation pour allumer/éteindre
- 2 "eARC": **eARC**
Appuyez sur cette touche pour passer au canal HDMI eARC.
- 3 "HD IN": **HD IN**
Appuyez sur cette touche pour passer au canal HDMI IN.
- 4 "OPT": **OPT**
Appuyez sur cette touche pour passer au canal OPTICAL.
- 5 "AUX": **AUX**
Appuyez sur cette touche pour passer au canal AUX.
- 6 "BT": **BT**
Appuyez sur cette touche pour passer au canal Bluetooth et entrer en mode d'appairage.
Maintenez cette touche enfoncée pendant 3 secondes pour déconnecter l'appareil actuel et le connecter manuellement à un nouvel appareil sur votre téléphone portable / PC / TV (BT ID : Apollo S60).
- 7 "USB": **USB**
Appuyez sur cette touche pour passer au canal USB.
- 8 "+": **Augmentation du volume**
- 9 "-": **Diminution du volume**
- 10 "<": **Précédent**
Pour les modes BT et USB uniquement : Passer à la piste précédente.
- 11 ">": **Suivant**
Pour les modes BT et USB uniquement : Passer à la piste suivante.
- 12 "▷||": **Lecture / Pause**
Pour les modes BT et USB uniquement.
Mode USB : Maintenez cette touche enfoncée pendant 3 secondes pour basculer entre la lecture d'une seule boucle et la lecture d'une liste de boucles.
- 13 "MOVIE": **MOVIE**
Appuyez sur cette touche pour passer au mode MOVIE.
- 14 "GAME": **JEU**
Appuyez sur cette touche pour passer en mode JEU.
- 15 "MUSIC": **MUSIQUE**
Appuyez sur cette touche pour passer au mode MUSIQUE.
- 16 "BASS MAX": **BASSMAX**
Appuyez sur cette touche pour régler le niveau des basses: "b5-2", "b5-1", "b5 0", "b5 1", "b5 2".
- 17 "🔊": **Mute / Récupérer le volume.**

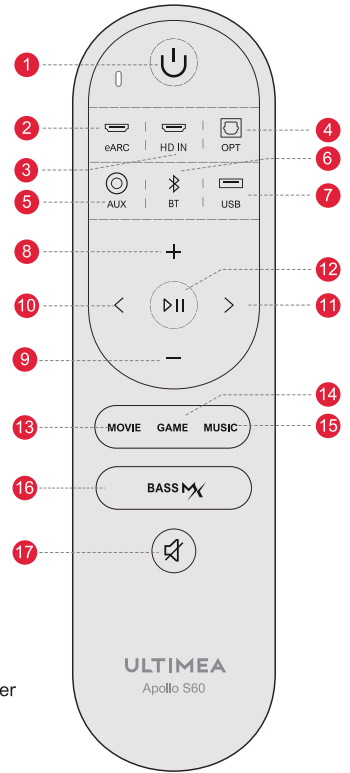

3 INSTALLATION DE LA BARRE DE SON

Étapes de l'assemblage :

- 1 Aligner les joints des deux parties.

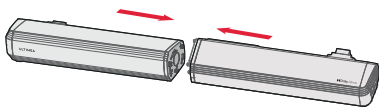

- 2 Tourner pour connecter.

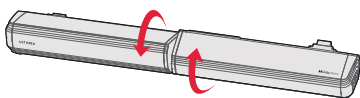

- 3 Branchez le câble à 4 broches pour la connexion de la barre de son.

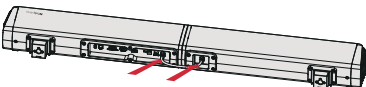

Détachée et posée sur la base :

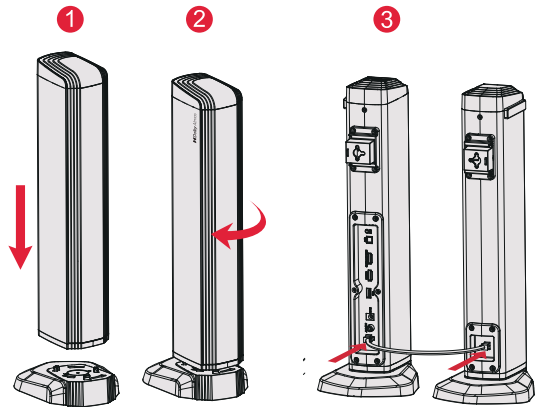

- 1 Placer la barre de son sur la base et aligner les joints.
- 2 Tourner pour connecter à la base.
- 3 Branchez le câble à 4 broches pour la connexion de la barre de son.

4 CONNECTER AU CAISSON DE BASSE

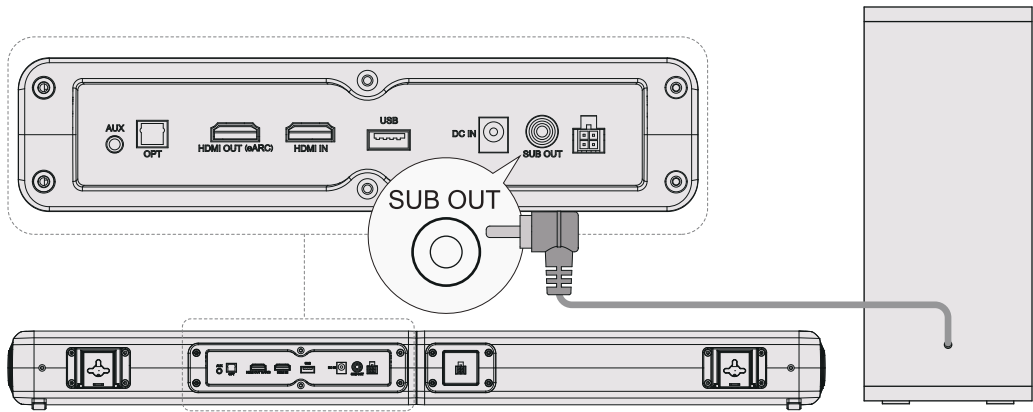

FR

5 CONNECTER AU TÉLÉVISEUR VIA ARC

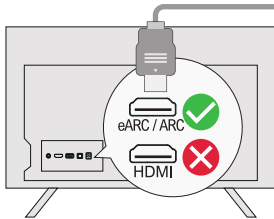

Étape 1:

Connectez une extrémité du câble HDMI au port eARC / ARC à l'arrière de votre téléviseur.

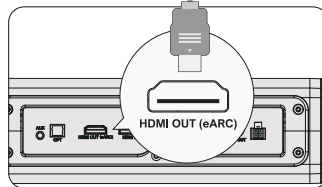

Étape 2:

Connectez ensuite l'autre extrémité au port HDMI OUT(eARC) de la barre de son.

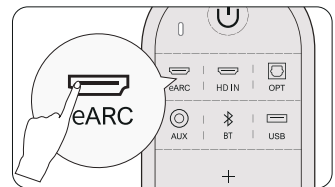

Étape 3:

Appuyez sur la touche "eARC" de la télécommande pour sélectionner l'entrée "eARC".

6 CONNEXION A UN AUTRE APPAREIL VIA HDMI IN

Étape 1

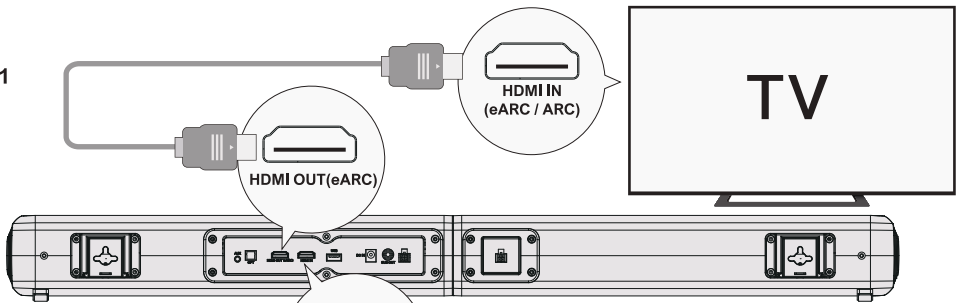

Étape 2

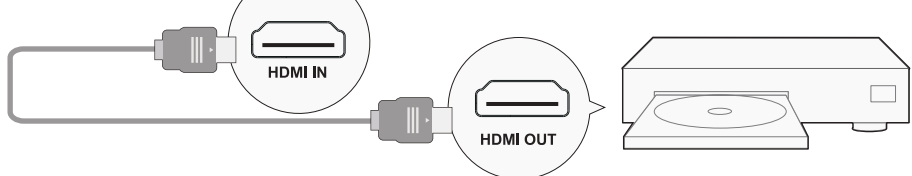

Étape 3

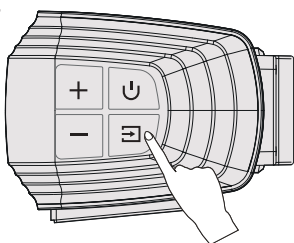

Étape 1: Connectez le câble HDMI au port HDMI OUT (eARC) de la barre de son et l'autre extrémité au port HDMI IN (eARC / ARC) du téléviseur.

Étape 2: Connectez le câble HDMI au port HDMI OUT de l'autre appareil (tel qu'un DVD ou une console de jeu) et l'autre extrémité au port HDMI IN de la barre de son.

Étape 3: Appuyez sur le bouton "HDMI IN" de la barre de son ou de la télécommande pour passer au canal HDMI IN.

Remarque: Le HDMI de votre TV doit prendre en charge l'eARC pour transmettre le format audio Dolby Atmos à votre Soundbar.

Remarque :

Assurez-vous que le HDMI de votre téléviseur prend en charge l'eARC, sinon le signal audio Dolby Atmos ne pourra pas être transmis.

Atmos: Si vous regardez un film au format Dolby Atmos, réglez la sortie audio de votre téléviseur sur Pass Through : Réglages TV > Accueil > Réglages > Son > Sortie audio numérique > Pass Through

DTS: Si vous regardez un film au format DTS, réglez la sortie audio de votre téléviseur sur PCM : Réglages TV > Accueil > Réglages > Son > Sortie audio numérique > PCM

Quelle est la différence entre : HDMI IN, HDMI ARC, HDMI eARC ?

HDMI IN est une entrée HDMI standard qui vous permet de connecter des appareils à votre téléviseur ou à votre système audio. Elle prend en charge les signaux audio et

Elle prend en charge les signaux audio et vidéo, mais ne prend pas en charge la fonctionnalité de canal de retour audio (ARC) ou de canal de retour audio amélioré (eARC).

HDMI ARC est un port HDMI spécial qui prend en charge la communication bidirectionnelle entre votre téléviseur et votre système audio. Cela signifie que

que l'audio peut être envoyé de votre téléviseur à votre système audio, et que le système audio peut renvoyer l'audio à votre téléviseur.

HDMI eARC (Enhanced Audio Return Channel) est une version actualisée du HDMI ARC qui prend en charge des formats audio de meilleure qualité tels que Dolby Atmos et DTS:X.

Remarque : veuillez activer la fonction "CEC" sur votre téléviseur.

Lorsque la fonction eARC / ARC est connectée, la télécommande de votre téléviseur peut contrôler simultanément la barre de son et le téléviseur :

- 1 Allumer / éteindre
- 2 Régler le volume

7 CONNEXION AU TÉLÉVISEUR VIA OPTIQUE / AUX

OPTIQUE

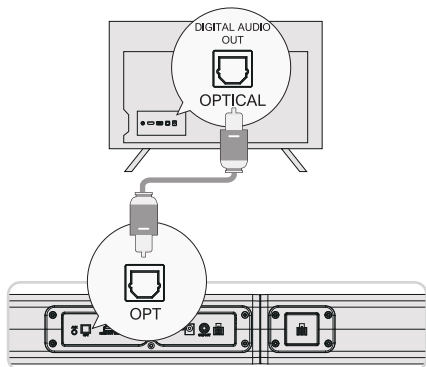

OPTION 1 : OPTIQUE

- 1 Assurez-vous que le port du téléviseur est OPTICAL OUT, connectez les deux côtés du câble à OPTICAL, à la fois pour le téléviseur et la barre de son.
- 2 Assurez-vous que la prise optique est insérée correctement, comme indiqué sur l'image. N'insérez pas la fiche à l'envers et ne cassez pas le câble optique.

Remarque: Si le son est diffusé par les haut-parleurs internes du téléviseur, mettez le volume du téléviseur en sourdine ou réduisez-le au minimum.

AUX

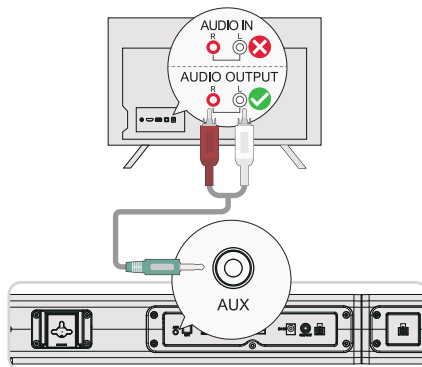

OPTION 2 : AUX

- 1 Connectez le câble audio 3.5 mm vers RCA au port RCA AUDIO OUT de votre téléviseur.
- 2 Assurez-vous que la couleur des extrémités du câble correspond à la couleur des ports du téléviseur.

Remarque: N'oubliez pas de débrancher le câble AUX de la télévision et de la barre de son lorsque vous souhaitez passer à un autre mode.

En mode optique : S'il n'y a pas de son, essayez de régler la sortie audio du téléviseur sur PCM:
Réglages du téléviseur > Accueil > Réglages > Son > Sortie audio numérique > PCM

8 CONNEXION AU BLUETOOTH®

- 1 Appuyez sur le bouton "⌂" de la barre de son ou appuyez sur le bouton "⌂" de la télécommande pour entrer dans le mode d'appairage Bluetooth.
- 2 Allez dans les paramètres Bluetooth de votre téléphone, trouvez et sélectionnez "Apollo S60" pour connecter la barre de son.

Remarque: Si la barre de son est déjà en mode Bluetooth et connectée, appuyez sur le bouton "⌂" pendant 3 secondes pour déconnecter l'appareil actuel et choisissez de vous connecter à un nouvel appareil manuellement sur votre téléphone portable / PC / TV.

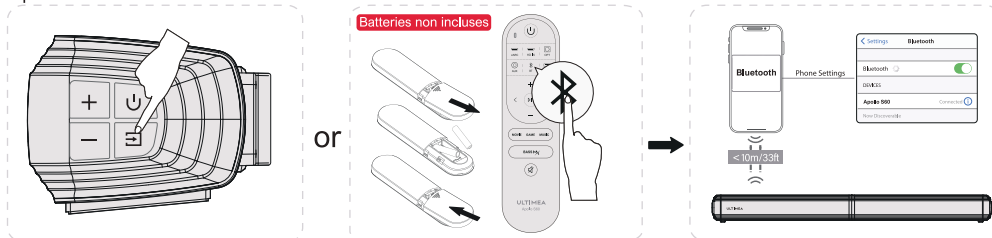

Détacher et se tenir sur la base

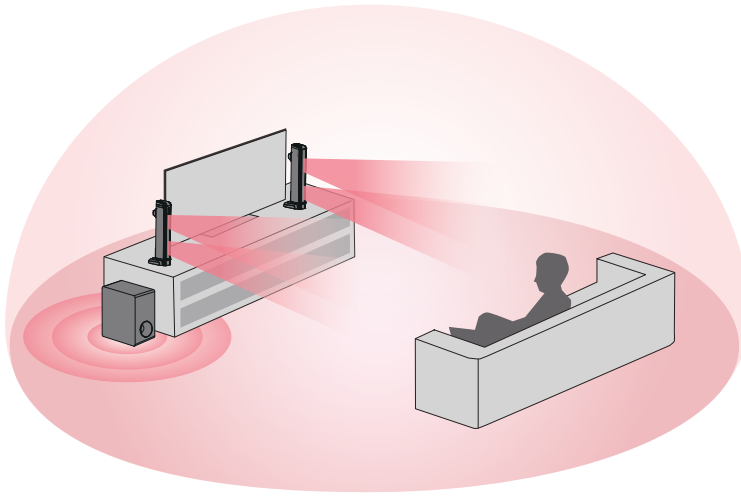

Placement horizontal

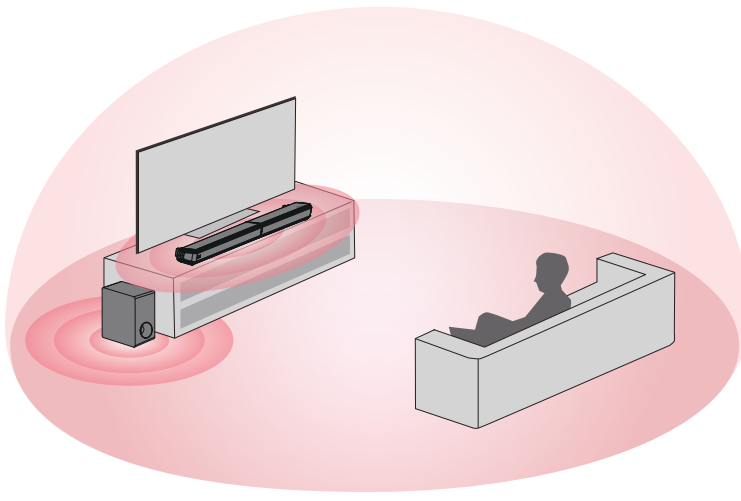

Remarque : La barre de son doit être placée à hauteur d'oreille ou presque.

10 INSTALLATION MURALE

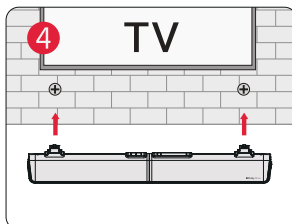
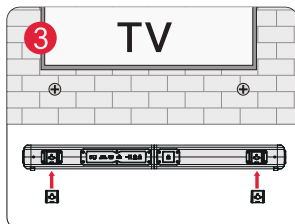
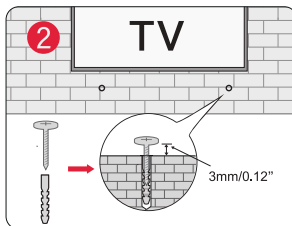
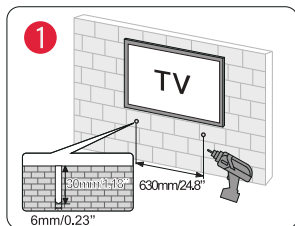

Numéro de modèle	U3620
Alimentation Électrique	AC 100-240V, ~50/60Hz
Pilotes de la barre de son	2.25" x 4 (barre de son) + 5.25" (caisson de basse)
Réponse en fréquence	45Hz - 18kHz
Puissance en veille	<0.5W
Température de fonctionnement	0°C - 45°C/32°F - 113°F
Version Bluetooth	5.3

Dimensions et poids		
Barre de son	811(W) × 98(D) × 70(H)	31.9" x 3.9" x 2.8"
Caisson de basse	270(W) × 115(D) × 27(H)	10.6" x 4.5" x 10.6"
Emballage	436(W) × 306(D) × 236(H)	17.2" x 12.15" x 9.3"
Poids net	4.6kg / 10.14lbs	
Poids brut	6.7kg / 14.77lbs	

ULTIMEA

Apollo S60

Manuale d'uso



Numero di modello: U3620

SIAMO PRONTI AD AIUTARE



support@ultimea.com

Preferite un video tutorial?

Video guida all'installazione o MANUALE D'USO sul sito web di ULTIMEA.

@ultimea_official



support.ultimea.com

+1 888-598-8875 (US) Mon-Fri 9am-5pm (PST)
+49 89-628-25828 (EU) Mon-Fri 9am-5pm (CET)

IT

1 ELENCO ACCESSORI



Soundbar

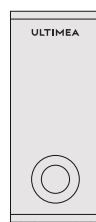

Subwoofer

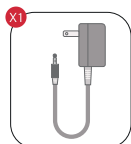

Adattatore di alimentazione

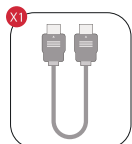

Cavo HDMI

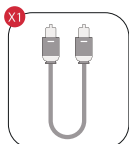

Câble optique numérique

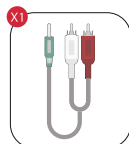

Cavo audio stereo da 3.5 mm a RCA

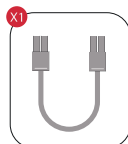

Cavo a 4 pin per il collegamento alla Soundbar (100 mm)

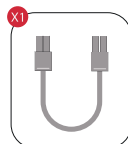

Cavo a 4 pin per il collegamento alla Soundbar (2.5 m)

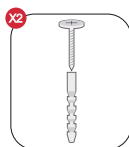

Kit per il montaggio a parete

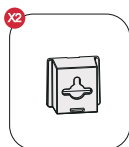

Staffa a muro



Telecomando

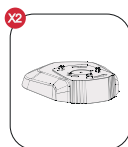

Base



Manuale d'uso

2 CONTROLLI DELLA SOUNDBAR

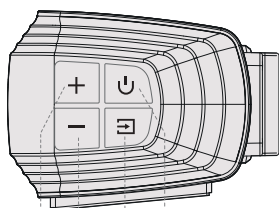

1 2 4 3

Pannello di controllo

- 1 **VOL+**: Volume su
- 2 **VOL-**: Volume giù
- 3 **Pulsante di accensione**:
Premere il pulsante di accensione per accendere/spgnere
- 4 **FONTE**:
Premere per cambiare canale: eARC-OPT(OPTICAL)-BT-AUX-USB.
Tenere premuto per 3 secondi per scollegare il dispositivo corrente e collegarlo manualmente a un nuovo dispositivo sul cellulare / PC / TV (ID BT: Apollo S60).

Telecomando

- 1 “**U**” : **Pulsante di accensione**
Premere il pulsante di accensione per accendere/spengere
- 2 “**eARC**” : **eARC**
Premere per passare al canale HDMI eARC.
- 3 “**HD IN**” : **HD IN**
Premere per passare al canale HDMI IN.
- 4 “**OPT**” : **OPT**
Premere per passare al canale OPTICAL.
- 5 “**AUX**” : **AUX**
Premere per passare al canale AUX.
- 6 “**BT**” : **BT**
Premere per passare al canale Bluetooth e accedere alla modalità di accoppiamento.
Tenere premuto per 3 secondi per scollegare il dispositivo corrente e collegarlo manualmente a un nuovo dispositivo sul telefono cellulare / PC / TV (ID BT: Apollo S60).
- 7 “**USB**” : **USB**
Premere per passare al canale USB.
- 8 “**+**” : **Volume su**
- 9 “**-**” : **Volume giù**
- 10 “**<**” : **Precedente**
Solo per la modalità BT e USB: Passa al brano precedente.
- 11 “**>**” : **successivo**
Solo per la modalità BT e USB: Passa alla traccia successiva.
- 12 “**▷||**” : **Riproduzione / Pausa**
Solo per la modalità BT e USB.
Modalità USB: Tenere premuto per 3 secondi per passare dalla riproduzione di un singolo loop alla riproduzione di un elenco di loop.
- 13 “**MOVIE**” : **FILMATO**
Premere per passare alla modalità MOVIE.
- 14 “**GAME**” : **GAME**
Premere per passare alla modalità GAME.
- 15 “**MUSIC**” : **MUSIC**
Premere per passare alla modalità MUSICA.
- 16 “**BASS MAX**” : **BASSMAX**
Premere per regolare il livello dei bassi; il display visualizza: “b5-2”, “b5-1”, “b5 0”, “b5 1”, “b5 2”.
- 17 “**🔇**” : **Silenziamento / Recupero del volume.**

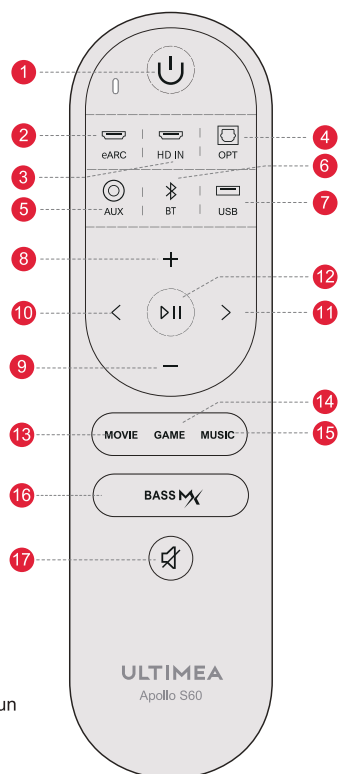

3 INSTALLAZIONE DELLA SOUNDBAR

Fasi di montaggio:

- 1 Allineare i giunti delle due parti.

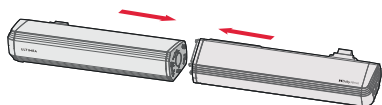

- 2 Ruotare per collegare.

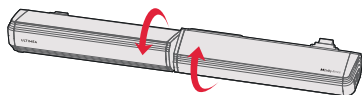

- 3 Inserire il cavo a 4 pin per il collegamento della Soundbar.

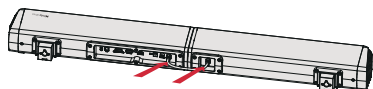

Staccare la soundbar e posizionarla sulla base:

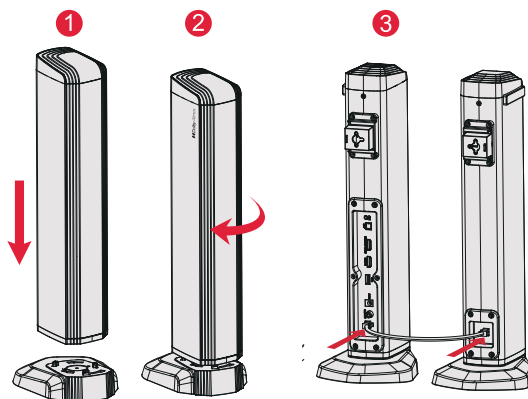

- 1 Posizionare la soundbar sulla base e allineare i giunti.
- 2 Ruotare per collegarla alla base.
- 3 Inserire il cavo a 4 pin per il collegamento della Soundbar.

4 COLLEGAMENTO AL SUBWOOFER

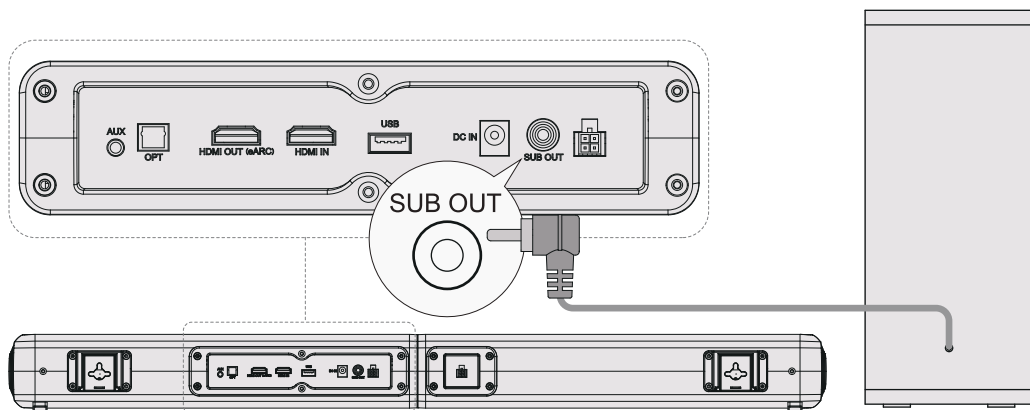

IT

5 COLLEGAMENTO ALLA TV VIA ARCO

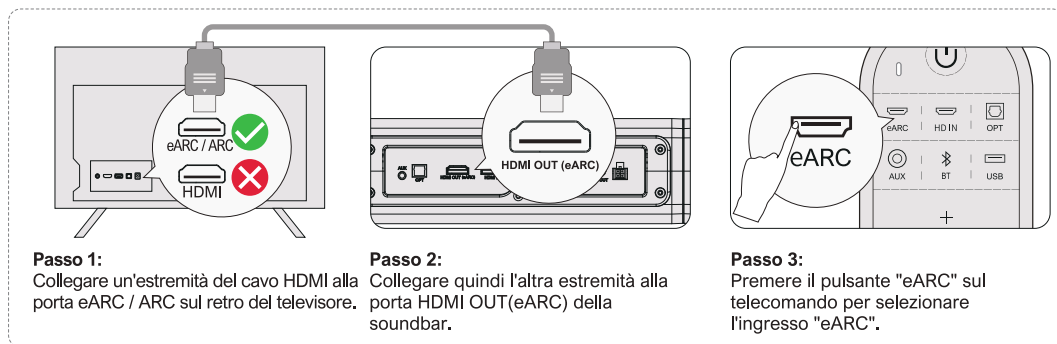

Passo 1:
Collegare un'estremità del cavo HDMI alla porta eARC / ARC sul retro del televisore.

Passo 2:
Collegare quindi l'altra estremità alla porta HDMI OUT (eARC) della soundbar.

Passo 3:
Premere il pulsante "eARC" sul telecomando per selezionare l'ingresso "eARC".

6 COLLEGAMENTO AD ALTRI DISPOSITIVI TRAMITE HDMI IN

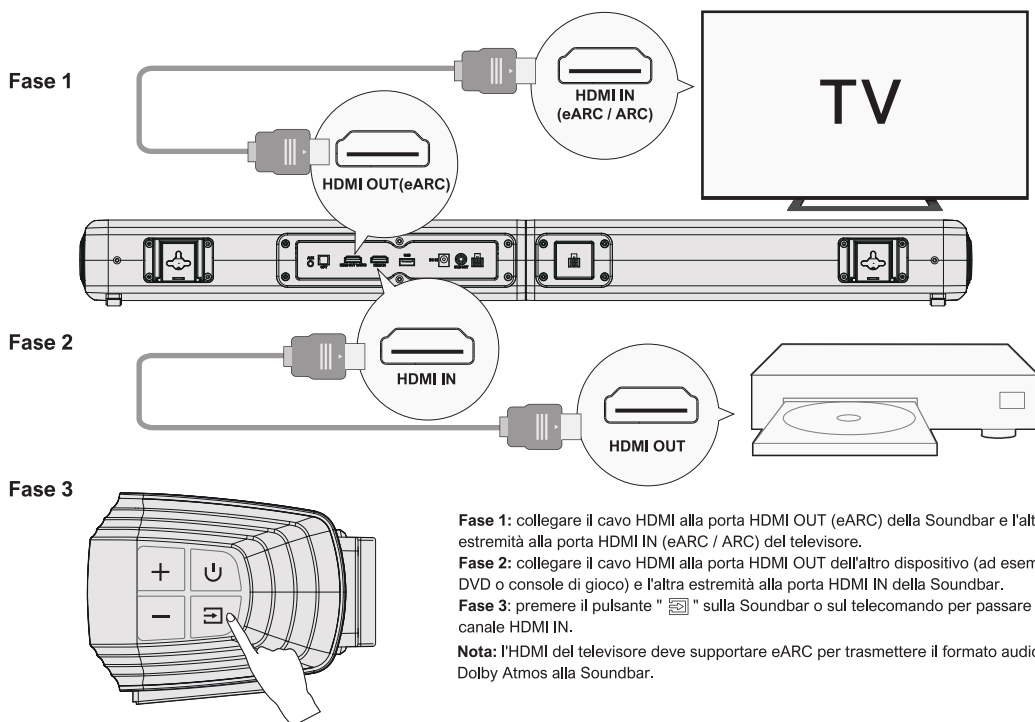

Fase 1: collegare il cavo HDMI alla porta HDMI OUT (eARC) della Soundbar e l'altra estremità alla porta HDMI IN (eARC / ARC) del televisore.

Fase 2: collegare il cavo HDMI alla porta HDMI OUT dell'altro dispositivo (ad esempio, DVD o console di gioco) e l'altra estremità alla porta HDMI IN della Soundbar.

Fase 3: premere il pulsante "HDMI IN" sulla Soundbar o sul telecomando per passare al canale HDMI IN.

Nota: l'HDMI del televisore deve supportare eARC per trasmettere il formato audio Dolby Atmos alla Soundbar.

Nota :

Assicurarsi che il televisore HDMI supporti eARC, altrimenti il segnale audio Dolby Atmos non può essere trasmesso.

Atmos: se si guarda un film in formato Dolby Atmos, impostare l'uscita audio del televisore su Pass Through:

Impostazioni TV > Home > Impostazioni > Suono > Uscita audio digitale > Passa attraverso

DTS: Se si guarda un film in formato DTS, impostare l'uscita audio del televisore su PCM:

Impostazioni TV > Home > Impostazioni > Suono > Uscita audio digitale > PCM

Qual è la differenza tra: HDMI IN, HDMI ARC, HDMI eARC?

HDMI IN è un ingresso HDMI standard che consente di collegare dispositivi al televisore o al sistema audio. Supporta segnali audio e segnali video, ma non supporta le funzionalità di canale di ritorno audio (ARC) o di canale di ritorno audio avanzato (eARC).

HDMI ARC è una porta HDMI speciale che supporta la comunicazione bidirezionale tra il televisore e il sistema audio. Ciò significa che l'audio può essere inviato dal televisore al sistema audio e il sistema audio può inviare l'audio al televisore.

HDMI eARC (Enhanced Audio Return Channel) è una versione aggiornata dell'HDMI ARC che supporta formati audio di qualità superiore, come Dolby Atmos e DSC.

come Dolby Atmos e DTS:X.

Nota: attivare la funzione "CEC" sul televisore.

Quando eARC / ARC è collegato, il telecomando del televisore può controllare contemporaneamente la soundbar e il televisore:

- 1 Accendere / spegnere
- 2 Regolare il volume

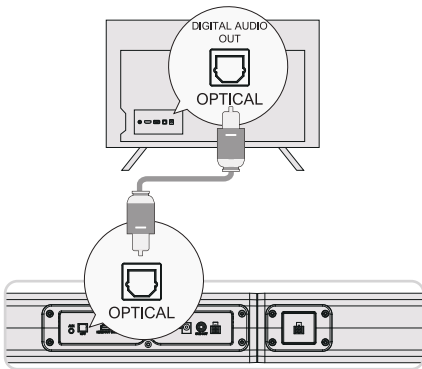
7 COLLEGAMENTO ALLA TV VIA OTTICO / AUX**OTTICO****OPZIONE 1: OTTICO**

1 Assicurarsi che la porta del televisore sia OPTICAL OUT, collegare entrambi i lati del cavo a OPTICAL, sia per il televisore che per la soundbar.

2 Assicurarsi che la spina ottico sia inserita correttamente come mostrato nell'immagine. Non inserire la spina al contrario e non rompere l'ottico.

Nota: se l'audio viene riprodotto dagli altoparlanti interni del televisore, disattivare o ridurre al minimo il volume del televisore.

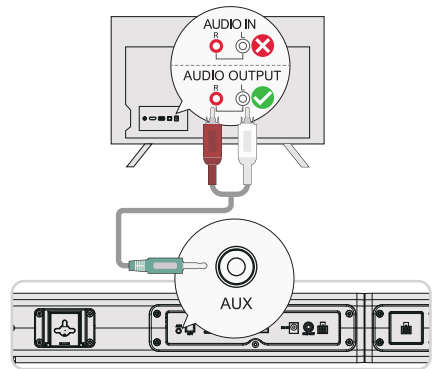
AUX**OPZIONE 2: AUX**

1 Collegare il cavo audio da 3.5 mm a RCA alla porta RCA AUDIO OUT del televisore.

2 Assicurarsi che il colore delle estremità dei cavi corrisponda a quello delle porte del televisore.

Nota: ricordarsi di scollegare il cavo AUX dal televisore e dalla Soundbar quando si desidera passare a un'altra modalità.

In modalità ottica: Se non si sente alcun suono, provare a impostare l'uscita audio del televisore su PCM:

Impostazioni TV > Home > Impostazioni > Audio > Uscita audio digitale > PCM

8 CONNESSIONE AL BLUETOOTH®

1 Premere il pulsante "⊞" della soundbar o il pulsante "⌘" del telecomando per accedere alla modalità di accoppiamento Bluetooth.

2 Accedere alle impostazioni Bluetooth del telefono, trovare e selezionare "Apollo S60" per collegare la soundbar.

Nota: se è già in modalità Bluetooth e collegata, tenere premuto il pulsante "⌘" per 3 secondi per scollegare il dispositivo corrente e scegliere di collegarsi a un nuovo dispositivo manualmente. scegliere di collegarsi a un nuovo dispositivo manualmente sul cellulare / PC / TV.

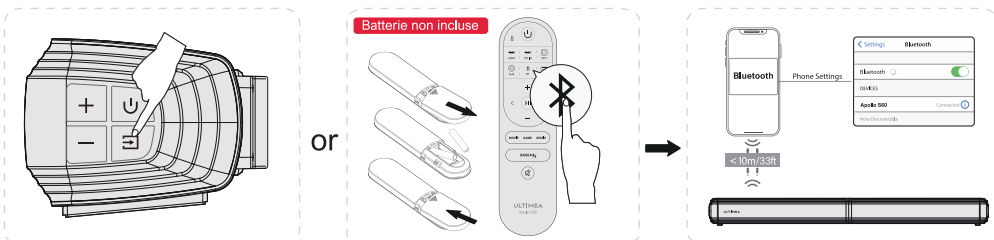

Staccati e appoggiati alla base

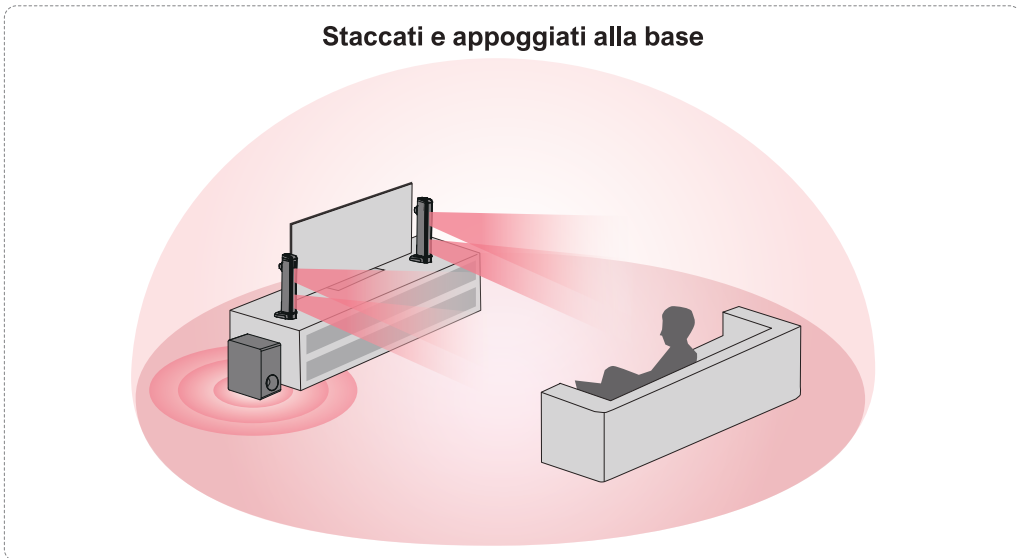

Posizionamento orizzontale

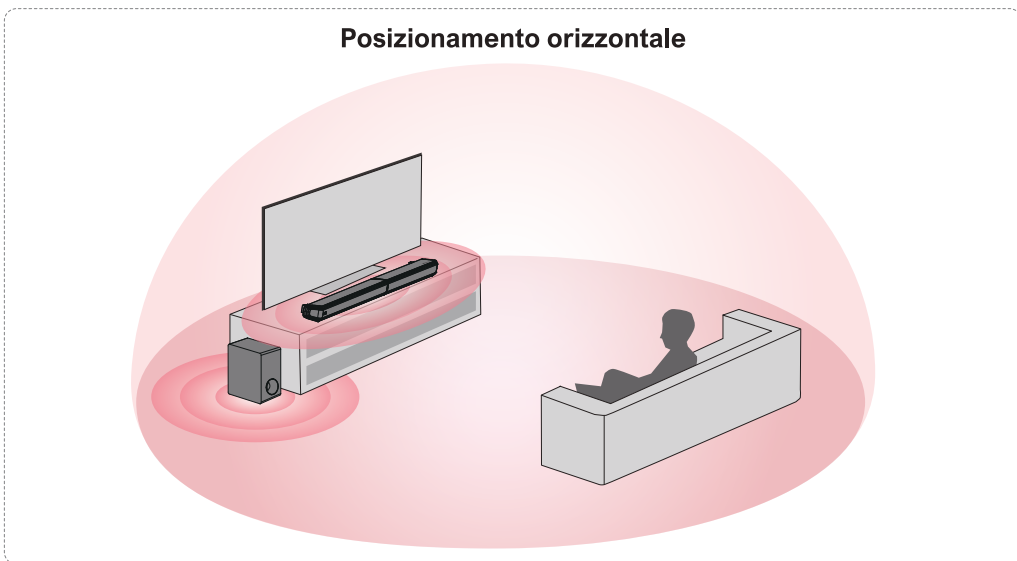

Nota: la soundbar deve essere posizionata all'altezza delle orecchie o vicino ad esse.

10 INSTALLAZIONE A PARETE

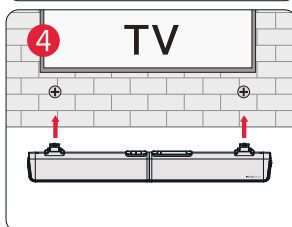
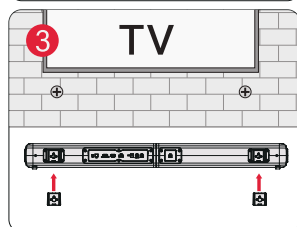
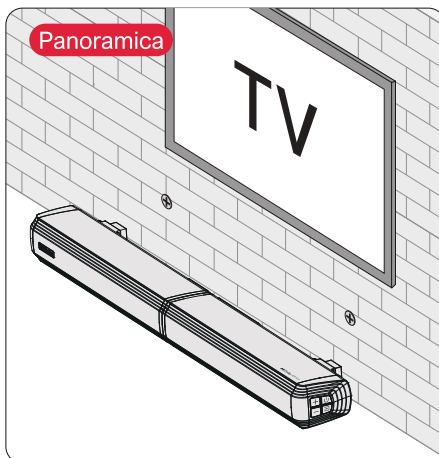
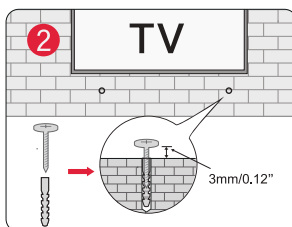
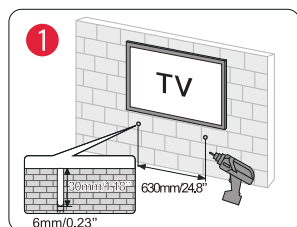

Numero di modello	U3620
Alimentazione	AC 100-240V, ~50/60Hz
Driver della barra audio	2.25" x 4 (barra audio) + 5.25" (subwoofer)
Risposta in frequenza	45Hz - 18kHz
Potenza in standby	<0,5W
Temperatura di esercizio	0°C - 45°C/32°F - 113°F
Versione Bluetooth	5.3

Dimensioni e peso		
Soundbar	811(W) × 98(D) × 70(H)	31.9" x 3.9" x 2.8"
Subwoofer	270(W) × 115(D) × 27(H)	10.6" x 4.5" x 10.6"
Imballaggio	436(W) × 306(D) × 236(H)	17.2" x 12.15" x 9.3"
Peso netto	4.6kg / 10.14lbs	
Peso lordo	6.7kg / 14.77lbs	

ULTIMEA

Apollo S60

Manual del usuario

ESTAMOS LISTOS PARA AYUDAR



support@ultimea.com



Número de modelo: U3620

¿Prefiere un tutorial en vídeo?

Vídeo guía de instalación o MANUAL DE USUARIO en el sitio web de ULTIMEA.

@ultimea_official



support.ultimea.com

ES

+1 888-598-8875 (US) Mon-Fri 9am-5pm (PST)
+49 89-628-25828 (EU) Mon-Fri 9am-5pm (CET)

1 LISTA DE ACCESORIOS

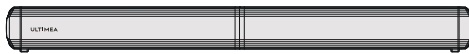

Barra de sonido

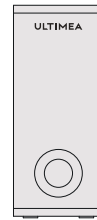

Subwoofer

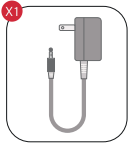

Adaptador de corriente

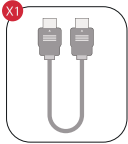

Cable HDMI

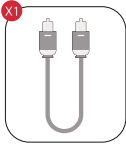

Cable digital óptico

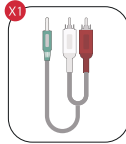

Estéreo de 3,5 mm a RCA Cable de audio

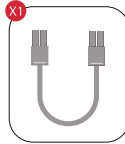

Cable de 4 clavijas para conexión de barra de sonido (100 mm)

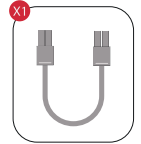

Cable de 4 clavijas para conexión de Soundbar (2,5 m)



Kit de montaje en pared

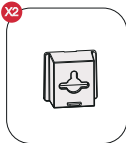

Soporte de pared



Mando a distancia

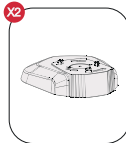

Base



Manual del usuario

2 CONTROLES DE LA BARRA DE SONIDO

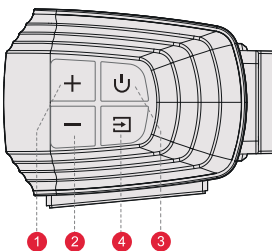

Panel de control

- 1 **VOL+**: Subir Volumen
- 2 **VOL-**: Bajar Volumen
- 3 **Botón de encendido**: Pulse el botón de encendido para encender/apagar
- 4 **FUENTE**: Pulse para cambiar de canal: eARC-OPT(ÓPTICO)-BT-AUX-USB. Mantenga pulsado durante 3 segundos para desconectar el dispositivo actual y conectarse a un nuevo dispositivo manualmente en su teléfono móvil / PC / TV (BT ID: Apollo S60).

Mando a distancia

- 1 "U": **Botón de encendido**
Pulse el botón de encendido para encender/apagar
- 2 "eARC": **eARC**
Púlselo para cambiar al canal HDMI eARC.
- 3 "HD IN": **HD IN**
Pulse para cambiar al canal HDMI IN.
- 4 "OPT": **OPT**
Pulse para cambiar al canal OPTICAL.
- 5 "AUX": **AUX**
Pulse para cambiar al canal AUX.
- 6 "BT": **BT**
Pulse para cambiar al canal Bluetooth y entrar en el modo de emparejamiento. Manténgalo pulsado durante 3 segundos para desconectar el dispositivo actual y conectarse a un nuevo dispositivo manualmente en su teléfono móvil / PC / TV (BT ID: Apollo S60).
- 7 "USB": **USB**
Pulse para cambiar al canal USB.
- 8 "+": **Subir volumen**
- 9 "-": **Bajar volumen**
- 10 "<": **Anterior**
Sólo para los modos BT y USB: Salta a la pista anterior.
- 11 ">": **Siguiente**
Sólo para los modos BT y USB: Salta a la pista siguiente.
- 12 "DII": **Reproducir / Pausa**
Sólo para los modos BT y USB.
Modo USB: Mantenga pulsado durante 3 segundos para cambiar entre reproducción de bucle simple y reproducción de bucle de lista.
- 13 "MOVIE": **MOVIE**
Pulse para cambiar al modo MOVIE.
- 14 "GAME": **JUEGO**
Pulse para cambiar al modo JUEGO.
- 15 "MUSIC": **MÚSICA**
Pulse para cambiar al modo MÚSICA.
- 16 "BASS MAX": **BASSMAX**
Pulse para ajustar el nivel de graves, la pantalla mostrará: "b5-2", "b5-1", "b5 0", "b5 1", "b5 2".
- 17 "Silencio": **Silenciar / Recuperar el volumen.**

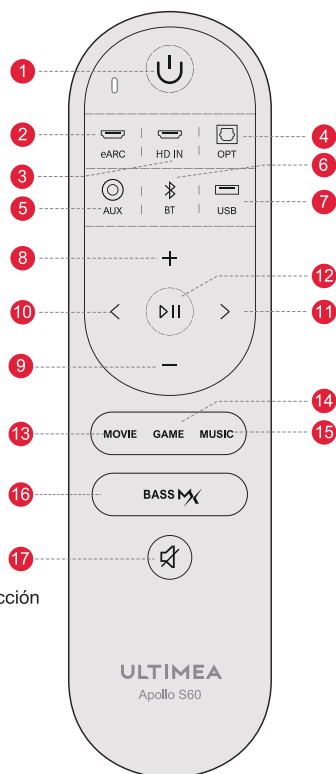

3 INSTALACIÓN DE LA BARRA DE SONIDO

Pasos de montaje:

- 1 Alinee las juntas de las dos partes.

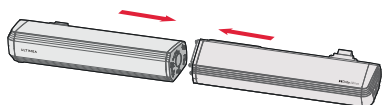

- 2 Gire para conectar.

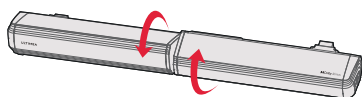

- 3 Enchufe el cable de 4 clavijas para la conexión de la barra de sonido.

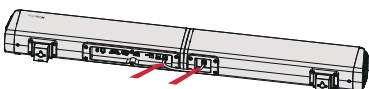

Desmontaje y colocación en la base:

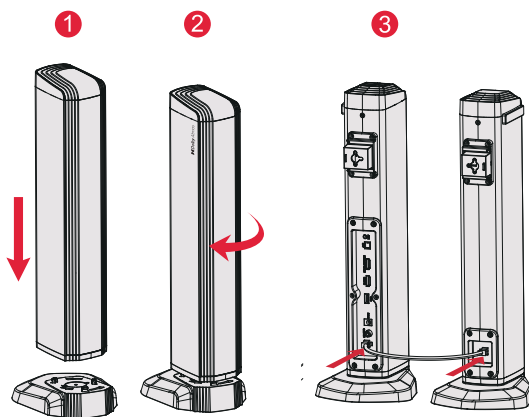

- 1 Coloque la barra de sonido sobre la base y alinee las juntas.
- 2 Gire para conectar con la base.
- 3 Enchufe el cable de 4 clavijas para la conexión de la barra de sonido.

4 CONECTAR AL SUBWOOFER

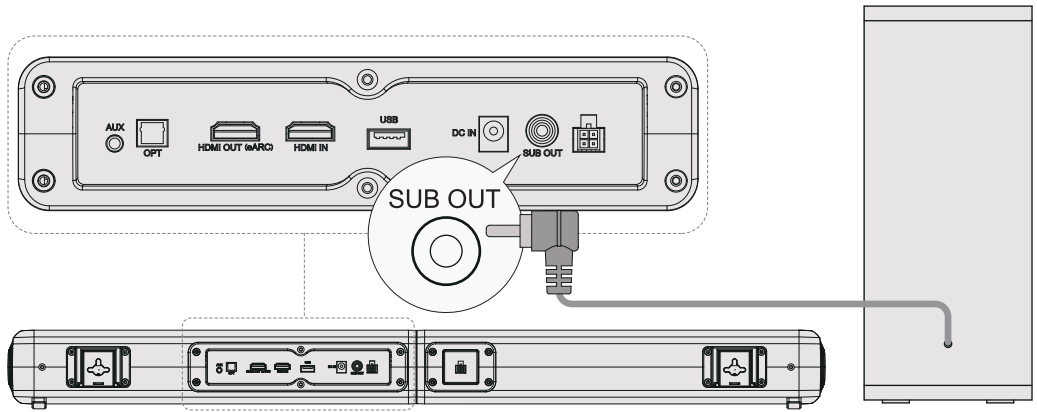

ES

5 CONECTAR A TV MEDIANTE ARCO



Paso 1:
Conecte un extremo del cable HDMI al puerto eARC / ARC de la parte posterior de su televisor.

Paso 2:
A continuación, conecte el otro extremo al puerto ARC de la barra de sonido.

Paso 3:
Pulse el botón "eARC" del mando a distancia para seleccionar la entrada "eARC".

6 CONECTE A OTRO DISPOSITIVO A TRAVÉS DE HDMI IN

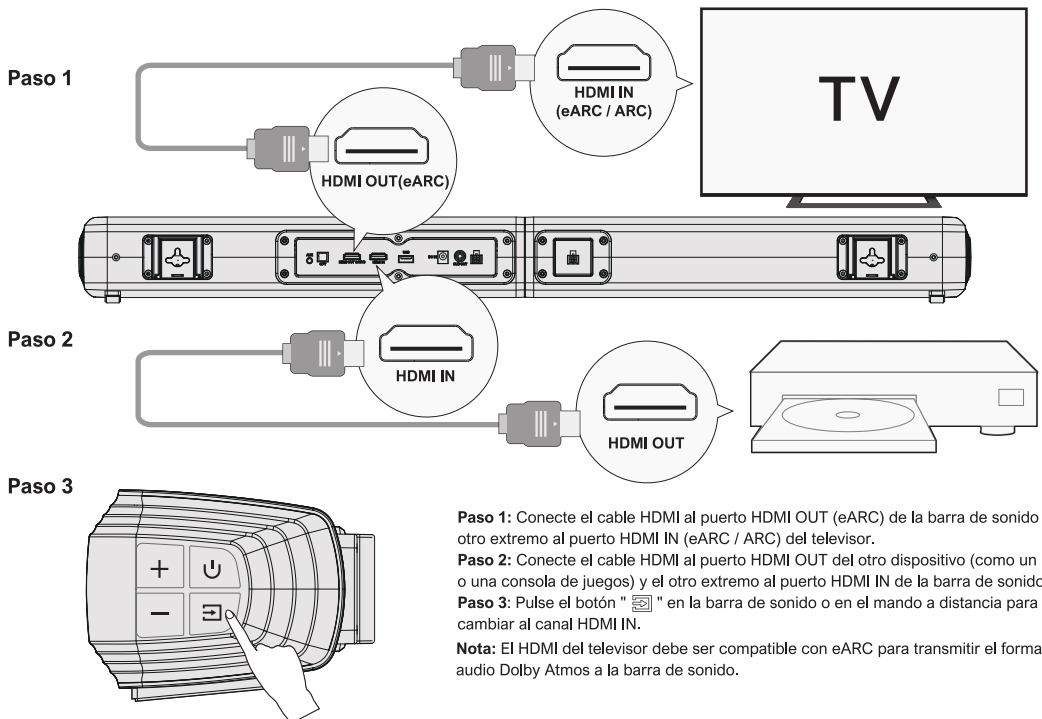

Paso 1

Paso 2

Paso 3

Paso 1: Conecte el cable HDMI al puerto HDMI OUT (eARC) de la barra de sonido y el otro extremo al puerto HDMI IN (eARC / ARC) del televisor.
Paso 2: Conecte el cable HDMI al puerto HDMI OUT del otro dispositivo (como un DVD o una consola de juegos) y el otro extremo al puerto HDMI IN de la barra de sonido.
Paso 3: Pulse el botón "HDMI" en la barra de sonido o en el mando a distancia para cambiar al canal HDMI IN.
Nota: El HDMI del televisor debe ser compatible con eARC para transmitir el formato de audio Dolby Atmos a la barra de sonido.

Nota :

Asegúrese de que su TV HDMI soporta eARC, de lo contrario la señal de audio Dolby Atmos no podrá ser transmitida.

Atmos: Si está viendo una película en formato Dolby Atmos, ajuste la salida de audio del televisor en Pass Through:

Ajustes TV > Home > Ajustes > Sonido > Salida Audio Digital > Pass Through

DTS: Si está viendo una película en formato DTS, configure la salida de audio del televisor como PCM:

Ajustes TV > Inicio > Ajustes > Sonido > Salida de audio digital > PCM

¿Cuál es la diferencia entre: HDMI IN, HDMI ARC, HDMI eARC?

HDMI IN es una entrada HDMI estándar que le permite conectar dispositivos a su televisor o sistema de audio. Admite señales de audio y

video, pero no admite la funcionalidad de canal de retorno de audio (ARC) o canal de retorno de audio mejorado (eARC).

HDMI ARC es un puerto HDMI especial que admite la comunicación bidireccional entre el televisor y el sistema de audio. Esto significa

Esto significa que el audio puede enviarse desde el televisor al sistema de audio, y el sistema de audio puede devolver el audio al televisor.

HDMI eARC (canal de retorno de audio mejorado) es una versión actualizada de HDMI ARC que admite formatos de audio de mayor calidad

como Dolby Atmos y DTS:X

Nota: Active la función "CEC" en su televisor.

Cuando eARC / ARC está conectado, el mando a distancia del televisor puede controlar la barra de sonido y el televisor simultáneamente:

- 1 Encender / apagar
- 2 Ajustar el volumen

ES

7 CONECTAR AL TELEVISOR POR VÍA ÓPTICO / AUX

ÓPTICO

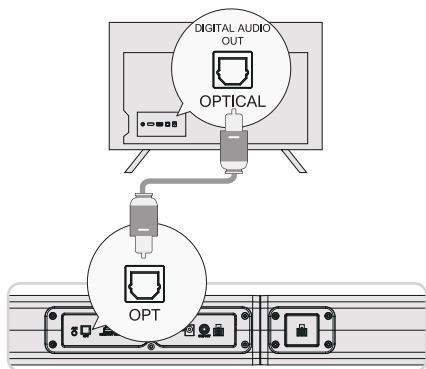

OPCIÓN 1 : ÓPTICO

- 1 Asegúrese de que el puerto del televisor es OPTICAL OUT, conecte ambos lados del cable a OPTICAL, tanto para el televisor como para la barra de sonido.
- 2 Asegúrese de que el conector óptico está insertado correctamente como se muestra en la imagen. No inserte la clavija al revés y rompa el cable óptico.

Nota: Si se reproduce audio por los altavoces internos del televisor, silencio o minimice el volumen del televisor.

AUX

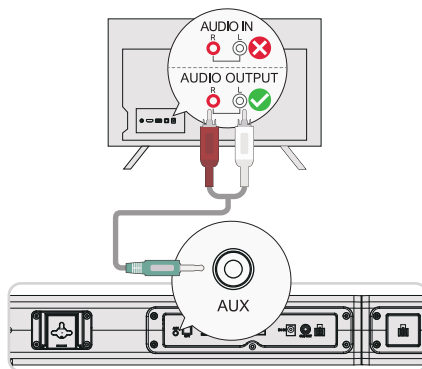

OPCIÓN 2: AUX

- 1 Conecta el cable de audio de 3.5 mm a RCA al puerto RCA AUDIO OUT de tu TV.
- 2 Asegúrese de que el color de los extremos de los cables coincide con el color de los puertos de TV.

Nota: Recuerde desconectar el cable AUX de la TV y del Soundbar cuando quiera cambiar a otro modo.

En Modo Óptico: Si no hay sonido, pruebe a ajustar la salida de audio del TV a PCM:
Ajustes TV > Inicio > Ajustes > Sonido > Salida Audio Digital > PCM

8 CONECTAR A BLUETOOTH®

- 1 Pulse el botón "⏻" en la barra de sonido o pulse el botón "⌘" en el mando a distancia para entrar en el modo de emparejamiento Bluetooth.
- 2 Vaya a la configuración Bluetooth de su teléfono, busque y seleccione "Apollo S60" para conectar la barra de sonido.

Nota: Si ya está en el modo Bluetooth y conectado, mantenga pulsado el botón "⌘" durante 3 segundos para desconectar el dispositivo actual y elija conectarse a un nuevo dispositivo manualmente en su teléfono móvil / PC / TV.

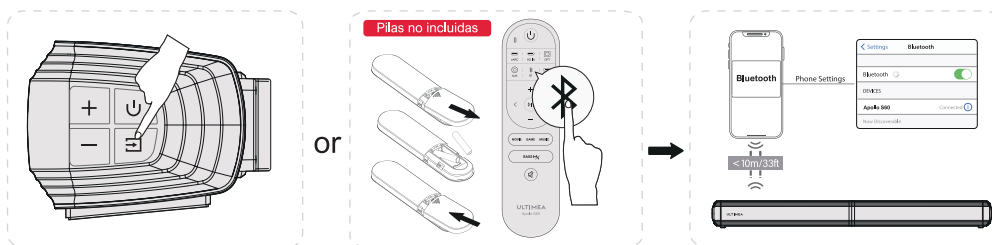

Independiente y de pie sobre la base

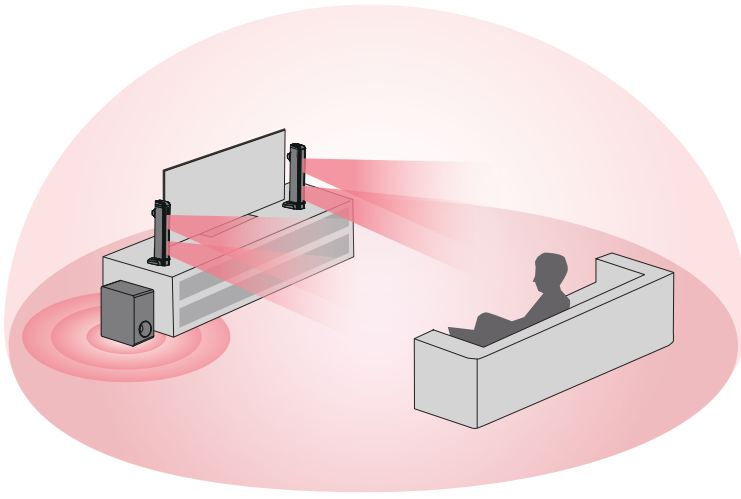

Colocación horizontal

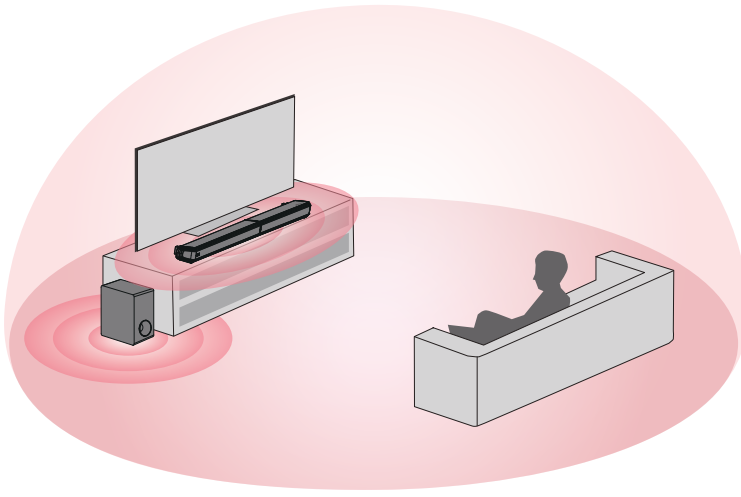

Nota: La barra de sonido debe colocarse a la altura de los oídos o cerca de ellos.

10 INSTALACIÓN MURAL

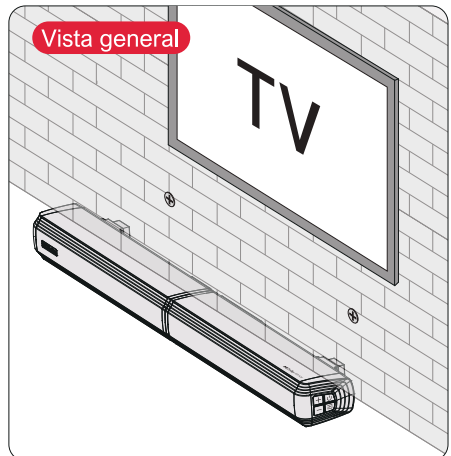
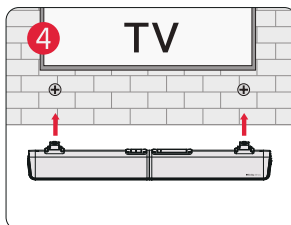
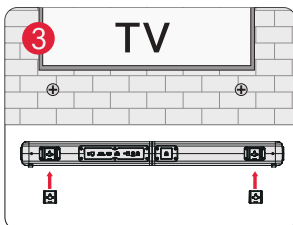
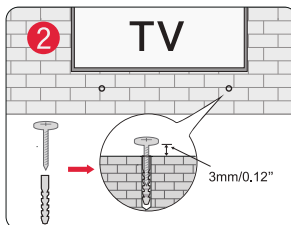
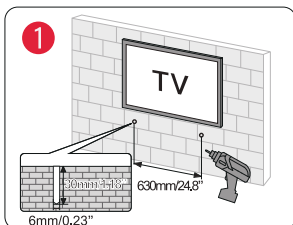

Número de modelo	U3620
Fuente de alimentación	AC 100-240V, ~50/60Hz
Controladores de la barra de sonido	2.25" x 4 (barra de sonido) + 5.25" (subwoofer)
Respuesta en frecuencia	45Hz - 18kHz
Potencia en espera	<0,5W
Temperatura de funcionamiento	0°C - 45°C/32°F - 113°F
Versión Bluetooth	5.3

Dimensiones y peso		
Barra de sonido	811(W) × 98(D) × 70(H)	31.9" x 3.9" x 2.8"
Subwoofer	270(W) × 115(D) × 27(H)	10.6" x 4.5" x 10.6"
Embalaje	436(W) × 306(D) × 236(H)	17.2" x 12.15" x 9.3"
Peso neto	4.6kg / 10.14lbs	
Peso bruto	6.7kg / 14.77lbs	

SAFETY INSTRUCTIONS

Please read this user manual carefully and save it for future reference.

Do not make unauthorized alterations to the product, doing so may compromise safety, regulatory compliance, system performance, and may void the warranty.

- Avoid dropping.
- Do not disassemble.
- Do not submerge in water
- Avoid extreme temperatures.
- Do not use the device outdoors during thunderstorms.
- Use original or certified cables.
- Do not place dangerous items on top of this device (e.g. liquid filled objects, lit candles).
- Clean with a dry, soft lint-free cloth. Do not use any corrosive cleaner or oil.
- To avoid hearing damage, do not listen for extended periods at high volume.
- Do not expose the batteries to extreme heat sources such as direct sunlight or open flames.
- The ideal operating temperature for this product and its accessories is between 41°F/5°C and 95°F/35°C.
- The adapter should be installed near the device and should be easily accessible.
- Do not use this product in environments of extreme heat or cold. Never expose this device to strong sunshine or wet environments.

PROPER DISPOSAL INSTRUCTIONS



This mark shown on the product or its packaging, indicates that this product should not be disposed of with other household waste at the end of its working life.

To prevent possible harm to the environment or human health from uncontrolled waste disposal, please separate this from other types of wastes and recycle it responsibly to promote the sustainable reuse of material resources.

Waste Electrical & Electronic Equipment

Household user should contact either the retailer where they purchased this product, or their local government office, for details of where and how they can take this item for environmentally safe recycling.

Business users should contact their suppliers and check the terms and conditions of the purchase contract. This product should not be mixed with other commercial wastes for disposal.

FCC REGULATORY COMPLIANCE

Any changes or modifications not expressly approved by the party responsible for compliance could void the user's authority to operate the equipment.

This device complies with Part 15 of the FCC Rules.

Operation is subject to the following two conditions:

- (1) This device may not cause harmful interference.
- (2) This device must accept any interference received, including interference that may cause undesired operation.

NOTE: This equipment has been tested and found to comply with the limits for a Class B digital device, pursuant to part 15 of the FCC Rules. These limits are designed to provide reasonable protection against harmful interference in a residential installation. This equipment generates, uses, and can radiate radio frequency energy, and if not installed and used in accordance with the instructions, may cause harmful interference to radio communications.

However, there is no guarantee that interference will not occur in a particular installation. If this equipment does cause harmful interference to radio or television reception, which can be determined by turning the equipment off and on, the user is encouraged to try to correct the interference by one or more of the following measures:

- Reorient or relocate the receiving antenna.
- Increase the separation between the equipment and the receiver.
- Connect the equipment to an outlet on a circuit different from that to which the receiver is connected.
- Consult the dealer or an experienced radio / TV technician for help.

This equipment complies with FCC radiation exposure limits set forth for an uncontrolled environment. This equipment should be installed and operated with a minimum distance of 20cm between the radiator & your body. This transmitter must not be co-located or operating in conjunction with any other antenna or transmitter.

ISED WARNINGS

This device contains licence-exempt transmitter (s) / receiver (s) that comply with Innovation, Science and Economic Development Canada's licence-exempt RSS (s). Operation is subject to the following two conditions:

- (1) This device may not cause interference.
- (2) This device must accept any interference, including interference that may cause undesired operation of the device.

L'émetteur/récepteur exempt de licence contenu dans le présent appareil est conforme aux CNR d'Innovation, Sciences et Développement économique Canada applicables aux appareils radio exempts de licence. L'exploitation est autorisée aux deux conditions suivantes:

- (1) L'appareil ne doit pas produire de brouillage;
- (2) L'appareil doit accepter tout brouillage radioélectrique subi, même si le brouillage est susceptible d'en compromettre le fonctionnement.

The device meets the exemption from the routine evaluation limits in section 2.5 of RSS 102 and compliance with RSS-102 RF exposure, users can obtain Canadian information on RF exposure and compliance.

Le dispositif rencontre l'exemption des limites courantes d'évaluation dans la section 2.5 de RSS 102 et la conformité à l'exposition de RSS-102 rf, utilisateurs peut obtenir l'information canadienne sur l'exposition et la conformité de rf.

This transmitter must not be co-located or operating in conjunction with any other antenna or transmitter. This equipment should be installed and operated with a minimum distance of 20 centimeters between the radiator and your body.

Cet émetteur ne doit pas être Co-placé ou ne fonctionnant en même temps qu'aucune autre antenne ou émetteur. Cet équipement devrait être installé et actionné avec une distance minimum de 20 centimètres entre le radiateur et votre corps.

Declaration of Conformity

We (Manufacturer is responsible for this declaration)
Ultimea Technology (Shenzhen) Limited
(Company name)

20th Floor, Building 4, Tianan Cloud Park, Bantian St.,
Longgang District Shenzhen, China 518000
(Company address)

Declare under our sole responsibility that the product
Trade Mark: ULTIMEA
Product Name: Apollo S60 4.1 Channel Dolby Atmos
Detachable Soundbar
Model No.: U3620

To which this declaration relates is in conformity with
the essential requirement set out in the Council Directive
on the Approximation of the laws of the Member States
relating to RED Directive (2014/53/EU) & RoHS (2011/
65/EU) product is responsible to affix CE marking, the
following standards were applied:

EN 55032:2015/A11:2020
EN 55035:2017/A11:2020
ENIEC 61000-3-2:2021
EN 61000-3-3:2013/A1:2021
ETSIEN 301 489-1 V2.2.3 (2019-11)
ETSIEN 301 489-17 V3.2.4 (2020-09)
EN 300 328 V2.2.2 (2019-07)
EN 50663:2017
ENIEC 62368-1:2020+A11:2020
IEC62321-3-1:2013
IEC 62321-4:2013+A1:2017
IEC 62321-5:2013
IEC 62321-6:2015
IEC 62321-7-1:2015
IEC 62321-7-2:2017
IEC 62321-8:2017

Full Name: Yoyo.Yu

Position: Approbation Manager

Signature: 

Place/Date: Shenzhen, China / Dec. 8-2023

Trade Marks:



Dolby, Dolby Atmos, and the double-D symbol are registered trademarks of Dolby Laboratories Licensing Corporation. Manufactured under license from Dolby Laboratories. Confidential unpublished works. Copyright© 2012-2021 Dolby Laboratories. All rights reserved.



The Bluetooth® word mark and logos are registered trademarks owned by Bluetooth SIG, Inc. and any use of such marks by Soundlab Technology Co.,Ltd. is under license. Other trademarks and trade names are those of their respective owners.



The Adopted Trademarks HDMI, HDMI High-Definition Multimedia Interface, HDMI trade dress and the HDMI Logos are trademarks or registered trademarks of HDMI Licensing Administrator, Inc. in the United States and other.

ULTIMEA

Apollo S60 4.1 Channel Dolby Atmos Detachable Soundbar
Model No.: U3620

 Ultimea GmbH
Buchenring 57, 22359 Hamburg, Germany

 UK CROSSBORDER LIMITED
7 Bell Yard London WC2A 2JR, UK United Kingdom
Made in China

Manufacturer: Ultimea Technology (Shenzhen) Limited
Address: 20th Floor, Building 4, Tianan Cloud Park, Bantian St.,
Longgang District, Shenzhen, China 518000

If you need our support, kindly reach out to our
service team. We are always glad to help.

+1 888-598-8875 (US)
Mon-Fri 9am-5pm (PST)
+49 89-628-25828 (EU)
Mon-Fri 9am-5pm (CET)

 support@ultimea.com

 support.ultimea.com



@ultimea_official