

ULTIMEA

Dolby Atmos

HDMI™
HIGH-DEFINITION MULTIMEDIA INTERFACE

Bluetooth®



User Manual

Skywave X50

Model No.: U422A
5.1.4 Channel Dolby Atmos Soundbar

1 IMPORTANT SAFETY INSTRUCTIONS

- Please read and keep these instructions. Follow all warnings and operate according to the instructions.
- Do not use the device near water, in damp environments, or in the rain. Avoid spilling liquids on the device or placing objects containing liquids (such as vases) on top of it.
- Clean only with a dry cloth. Do not use liquid cleaners.
- Do not block ventilation openings or install the device in a confined space. Ensure proper ventilation and install the device according to the manufacturer's instructions.
- Do not install the device near heat sources such as radiators, stoves, amplifiers, or other devices that produce heat. Do not cover the ventilation openings with items like newspapers or curtains.
- Only use attachments, stands, or accessories specified by the manufacturer. When using equipment with wheels, exercise caution when moving to prevent tipping.
- Protect the power cord from being walked on, pinched, or bent, especially at plugs, convenience receptacles, and the point where they exit from the device.
- Do not modify the plug's polarization or grounding features. If the plug does not fit into the outlet, consult an electrician to replace the outlet.
- Unplug the power cord during lightning storms or when not in use for long periods. To completely disconnect the device from the power supply, unplug it from the wall outlet and ensure the plug is easily accessible.
- Do not place any open flame sources, such as lit candles, on the device.
- Do not attempt to open the device. High voltage inside may cause electric shock or death. There are no user-serviceable parts inside. All servicing must be performed by qualified personnel.
- The installation height of the device must not exceed 2 meters.

2 ACCESSORIES LIST

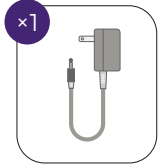
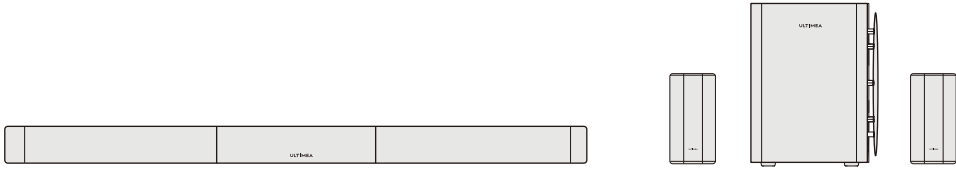

×1
Soundbar Power Adapter(2m / 78")

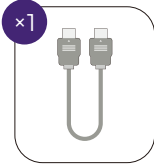

×1
HDMI Cable (1.5m / 59")

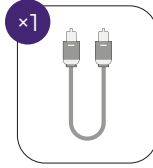

×1
Digital Optical Cable(1.5m / 59")

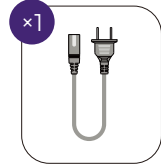

×1
Subwoofer Power Cord(2m / 78")

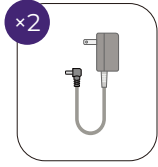

×2
Surround Power Adapter(3m / 118")

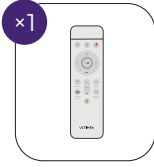

×1
Remote Control

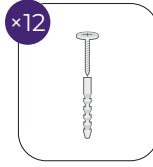

×12
Bracket Screw

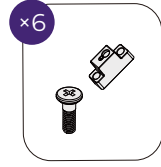

×6
Wall Anchor & Bracket

3 SOUNDBAR CONTROLS

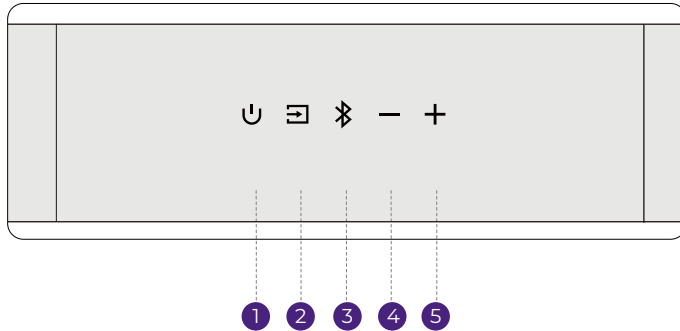

Control Panel

- 1 “U”: Power Button**
Press to power on / standby.
- 2 “☒”: Source**
Press to switch channels: eARC - HDMI IN - OPT(OPTICAL) - BT - USB.
- 3 “⌘”: Bluetooth**
Press to switch to Bluetooth mode. The Soundbar will automatically enter pairing mode. Press and hold for 3 seconds to disconnect the current device and pair with a new one manually from your smartphone, PC, or TV. (Bluetooth ID: Skywave X50)
- 4 “-”: Volume Down**
- 5 “+”: Volume Up**

4 Remote Control

- 1 “U” : Power Button**
Press to power on / standby.
- 2 “☐” : SOURCE**
Press to switch channels.
- 3 “⌘” : BT**
Press to switch to BLUETOOTH channel.
- 4 “+” : Volume Up**
- 5 “-” : Volume Down**
- 6 “<” : Previous**
For BT and USB mode only: Skip to previous track.
- 7 “>” : Next**
For BT and USB mode only: Skip to next track.
- 8 “||” : Play / Pause**
For BT and USB mode only.
- 9 “EQ” : EQ Mode**
Press to switch to EQ mode:
Standard, Cinema, Music, Voice, Game, Night.
- 10 “X” : Xupmix**
The default setting is “on”, allowing for unified control over the activation and deactivation of 6 sound effect modes.
Xupmix on: The surround channel sound will be provided by a rich multi-channel signal processed by the algorithm, offering a more immersive auditory experience.
Xupmix off: The surround channel sound will be optimized based on the left and right channel signals using an algorithm, resulting in a broader sound field effect.
- 11 “BASS +/-” : BASS**
Press to adjust bass level.
- 12 “Up-Firing” : Up-Firing Level**
Press to adjust the sky unit volume.
- 12 “Surround” : Surround Level**
Press to adjust surround sound level
- 13 “MUTE” : MUTE**
Press to Mute.
Press and hold the MUTE button for 5 seconds to restore factory settings

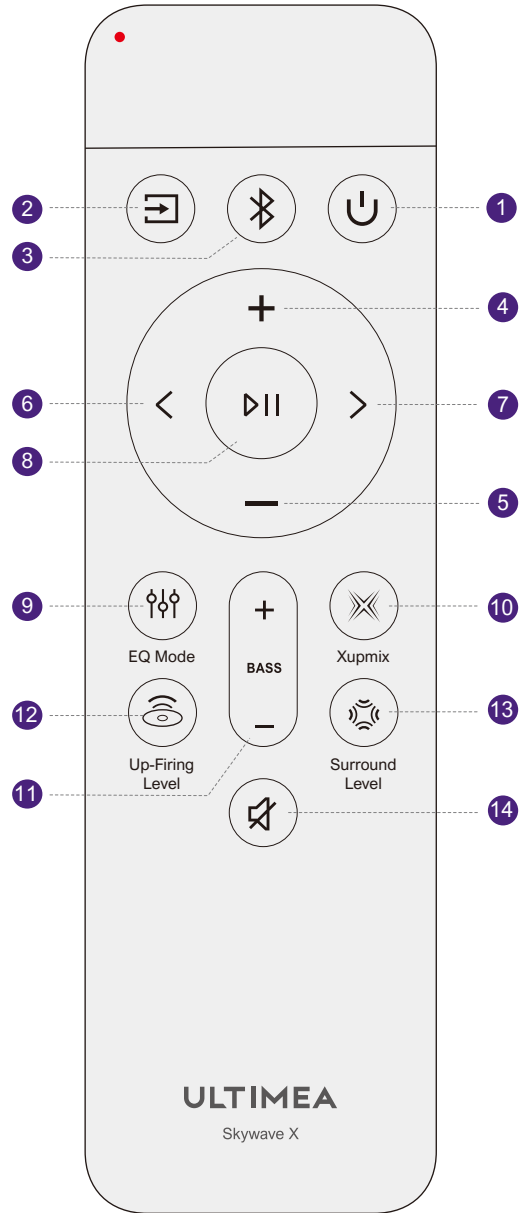

5 SOUNDBAR INSTALLATION

Align the joints of the three sections and twist them together until securely connected.
Caution: Make sure the soundbar is powered off during assembly.

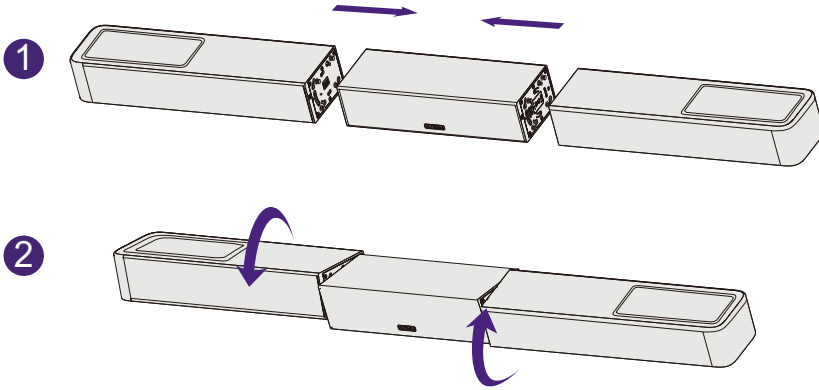

6 REAR PANEL

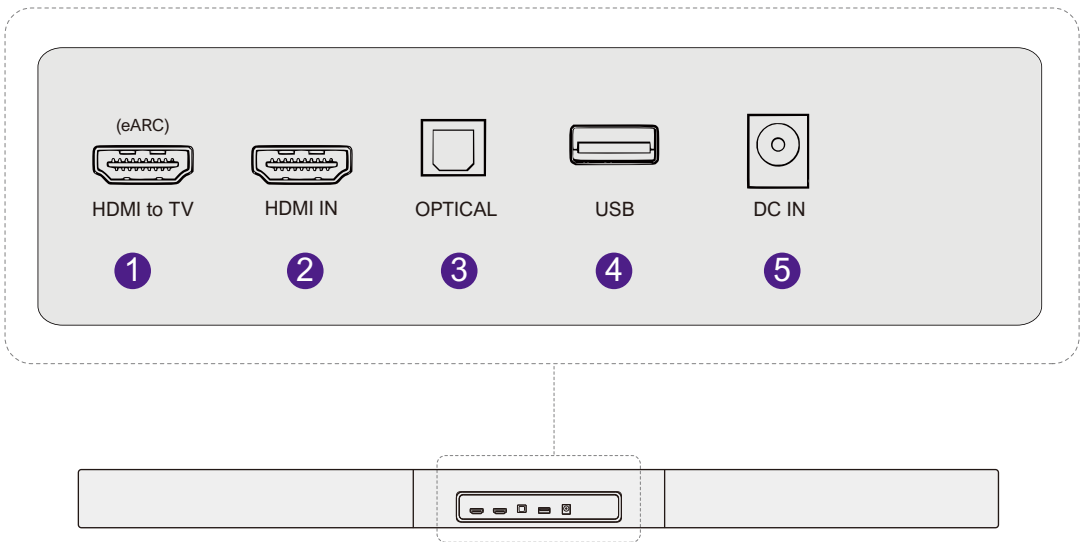

1 HDMI to TV(eARC)

4 HDMI IN

2 OPTICAL

5 DC IN

3 USB (Support MP3 or flac files)

7 SYSTEM PLACEMENT

Note: Place the soundbar at or near ear level for the best sound performance

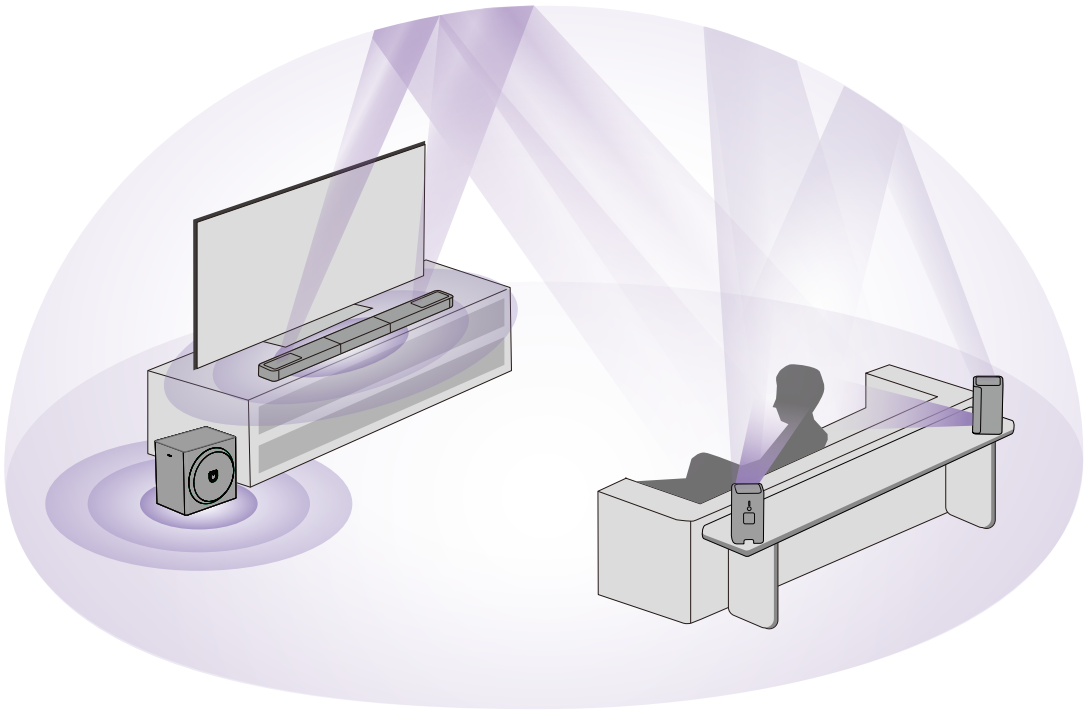

8 WALL MOUNT INSTALLATION

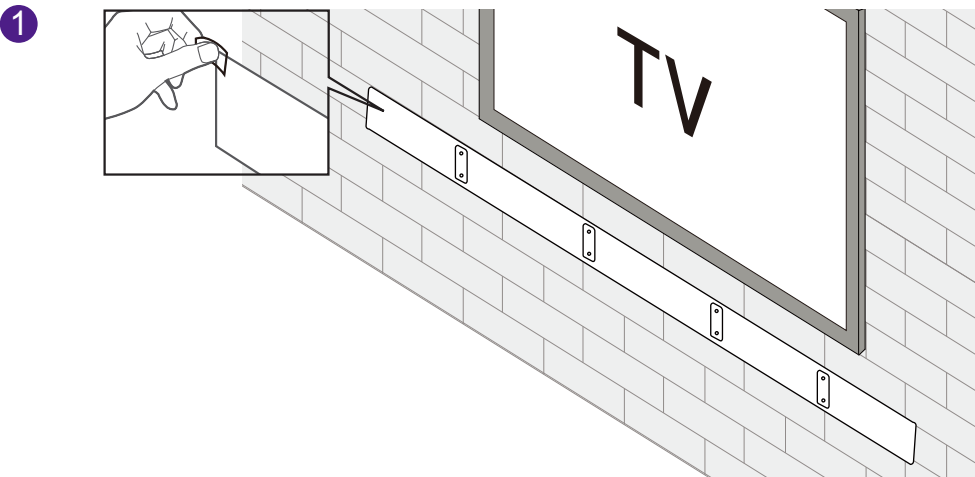

Attach the Wall-Mounting Guide to the wall to mark the correct drilling locations.

2

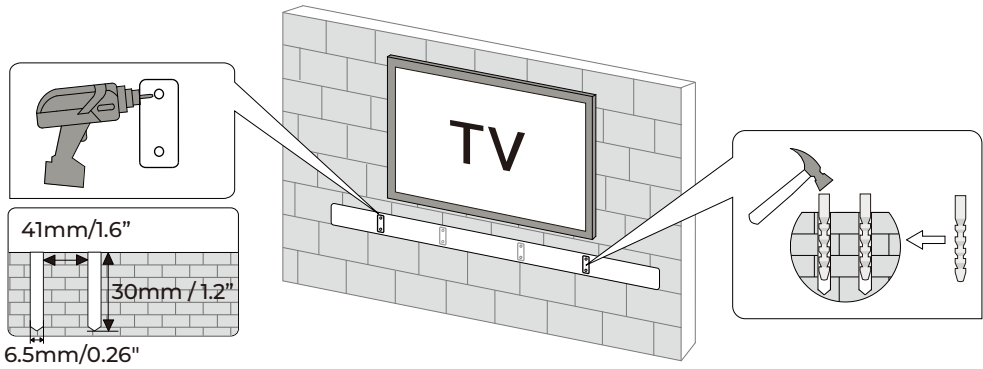

Install the left and right brackets first, add the middle one if needed.

3

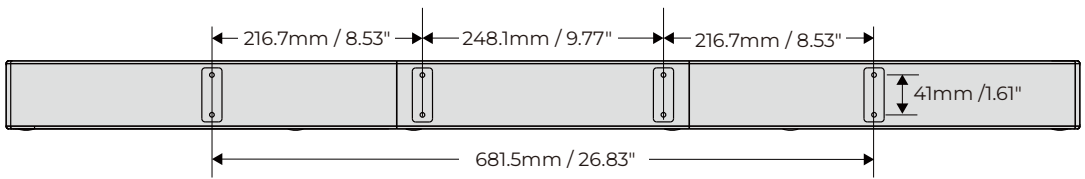

4

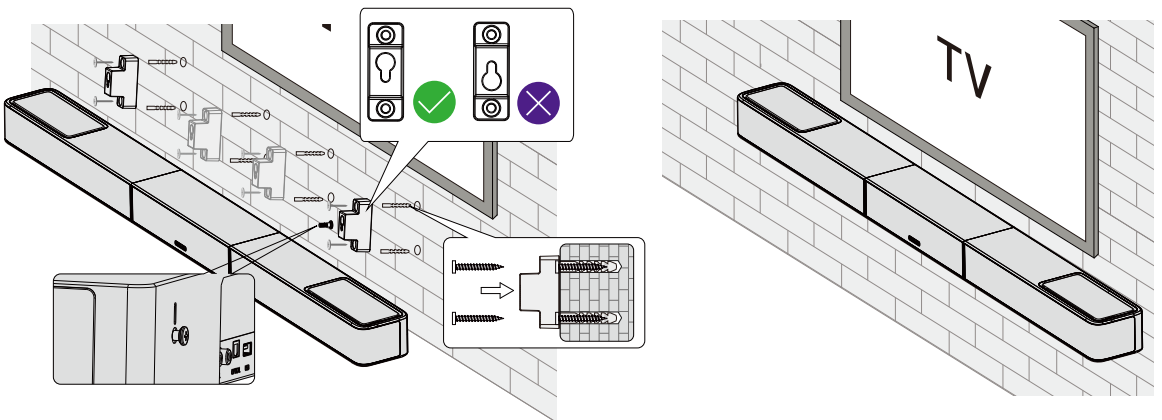

When mounting the wall bracket, make sure the bracket is fixed in the correct direction.

9 CONNECT AND POWER ON

- 1 Power the Soundbar.

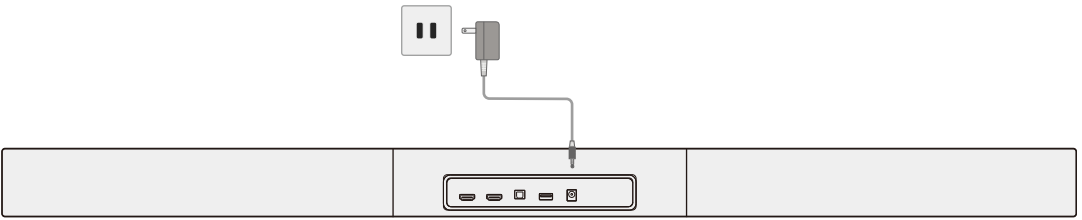

- 2 Power the Subwoofer.

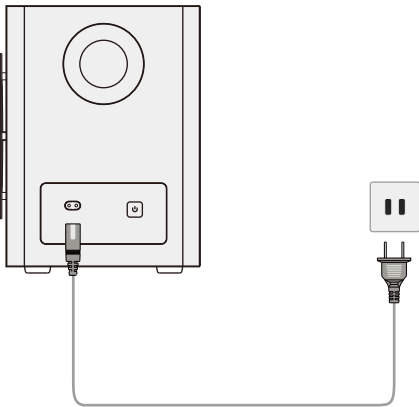

- 3 Power the surround speak-

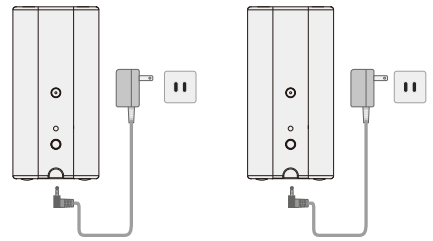

- 4 Insert batteries into the remote.

Note: It is recommended to use disposable alkaline batteries. Rechargeable batteries are not recommended.

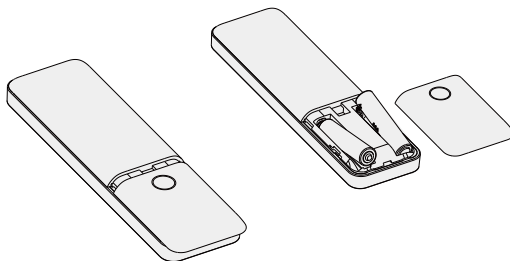

10 CONNECT TO TV VIA HDMI eARC

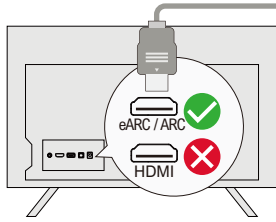

Step 1:

Connect one end of the HDMI cable to the eARC / ARC port on the back of your TV.

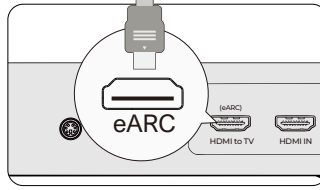

Step 2:

Then connect the other end into the eARC port of the soundbar.

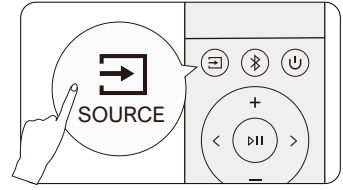

Step 3:

Press the "Source" button on the remote control and select the "eARC" input.

Note:

Make sure your TV HDMI supports eARC, otherwise the Dolby Atmos audio signal cannot be transmitted.

Dolby Atmos: If you are watching a movie in the Dolby Atmos format, please set the audio output on your TV to Pass Through:

TV Settings > Home > Settings > Sound > Digital Audio Output > Pass Through

DTS: If you are watching a movie in the DTS format, please set the audio output on your TV to PCM:

TV Settings > Home > Settings > Sound > Digital Audio Output > PCM

What's the difference between: HDMI IN, HDMI ARC, HDMI eARC?

HDMI IN is a standard HDMI input that allows you to connect devices to your TV or audio system. It supports audio and video signals, but it does not support audio return channel (ARC) or enhanced audio return channel (eARC) functionality.

HDMI ARC is a special HDMI port that supports two-way communication between your TV and audio system. This means that audio can be sent from your TV to your audio system, and audio system can send audio back to your TV.

HDMI eARC (Enhanced Audio Return Channel) is an updated version of HDMI ARC that supports higher quality audio formats such as Dolby Atmos.

Note: Please turn on the "CEC" function on your TV.

When eARC / ARC is connected, your TV remote control can control the soundbar and TV simultaneously: ① Turn on / standby ② Adjust the volume

11 CONNECT TO TV VIA OPTICAL CABLE

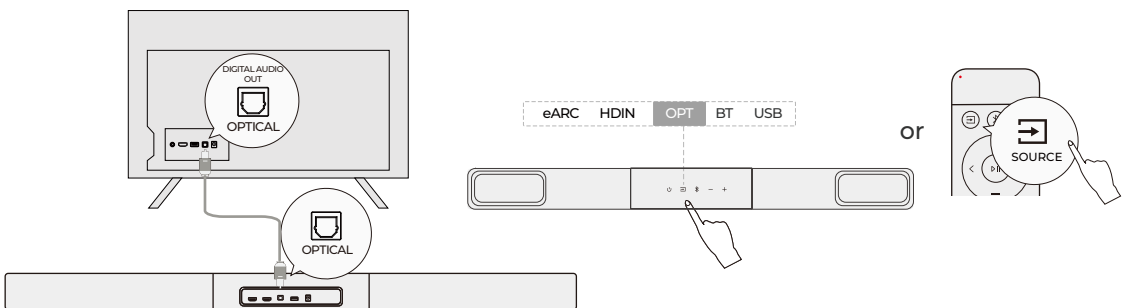

① Make sure the TV's port is OPTICAL OUT, connect both sides of the cable to OPTICAL, for both the TV and the soundbar.

② Make sure the optical plug is inserted correctly as it shows in the picture. Do not insert the plug upside down and break the optical.

TV Settings > Home > Settings > Sound > Digital Audio Output > PCM

Note: If audio is playing from the internal TV speakers, mute or minimize the TV volume.

The optical port does not support Dolby Atmos, it only supports Dolby Digital Plus (7.1). For the best Dolby Atmos experience, use HDMI IN or HDMI eARC.

12 CONNECT EXTERNAL DEVICES

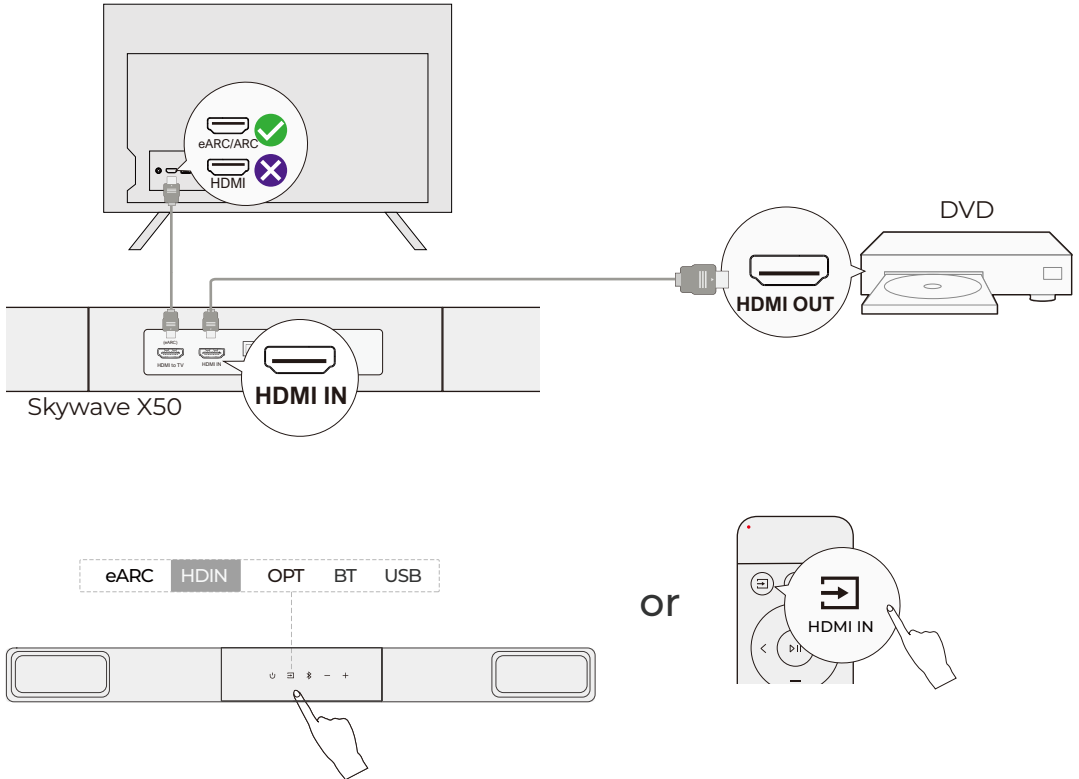

Connecting External Devices: TV Box, DVD Player, Amazon Fire TV Cube, Game Console, etc.

Such as DVD Connection:

Step 1: Connect the HDMI cable from the HDMI OUT port on the DVD player (or other external device) to the HDMI IN port on the Soundbar.

Step 2: Connect another HDMI cable from the HDMI OUT (eARC) port on the Soundbar to the HDMI eARC/ARC port on the TV.

(Note: Your TV HDMI needs to support eARC to transmit the Dolby Atmos audio format to your Soundbar.)

Step 3: Press the "→" button on the Soundbar or Remote Control to switch to the HDMI IN channel.

Settings:

Step 1: Set the Soundbar's input mode to "HDMI IN".

Step 2: Set the DVD player's audio output format to "Bitstream" or "Auto".

Please note that the soundbar does not support the DTS format.

Please change your audio output format to Dolby Atmos, Dolby Digital (or Dolby Digital Plus), or PCM / Stereo. After switching, restart your playback so the change takes effect.

Alternative Connection for External Devices

Example: Chromecast / Fire TV Stick TV Soundbar

-Plug the Chromecast or Fire TV Stick into one of the HDMI IN ports on your TV.



-Use an HDMI cable to connect your TV's HDMI eARC/ARC port to the Soundbar's HDMI OUT (eARC) port.

-Set your TV's audio output to "External Speakers" or "HDMI (ARC/eARC)".

-Select "TV/eARC" as the input source on the Soundbar.

-On your TV, switch the input/source to the HDMI port where the Chromecast or Fire TV Stick is connected.

13 CONNECT TO BLUETOOTH

- 1 Press the “” button on the soundbar or press the “” button on the remote control to enter Bluetooth pairing mode.
- 2 Go to the Bluetooth setting on your phone, find and select “**Skywave X50**” to connect the soundbar.
- 3 Note: If it's already in the Bluetooth mode and connected, press and hold “” button for 3 seconds to disconnect current device and choose to connect to a new device manually on your mobile phone / PC / TV.

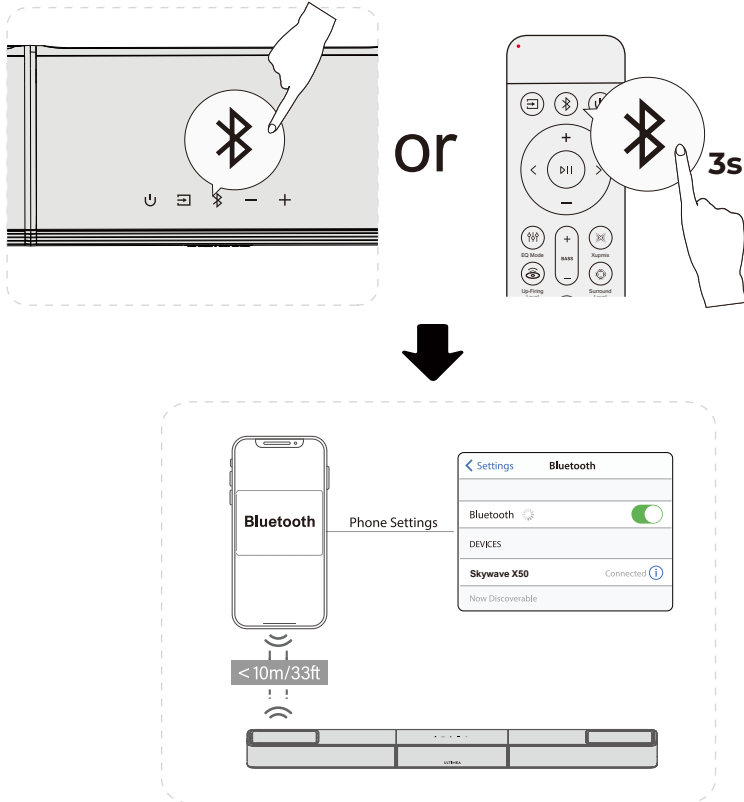

14 RE-PAIR SUBWOOFER

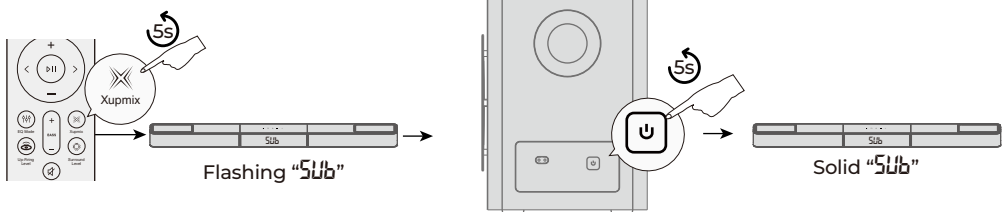

Normally, the Soundbar and subwoofer are pre-paired. If the connection is lost, please follow the steps below to re-pair them:

- 1 Press and hold the “Xupmix” button on the remote control for 5 seconds. The main unit display will flash “SUB” to indicate pairing mode.
- 2 Press and hold the pairing button on the back of the subwoofer for 5 seconds to enter pairing mode.
- 3 When pairing is successful, the main unit display will stop flashing and the subwoofer indicator light will remain steadily on.

15 RE-PAIR SURROUND

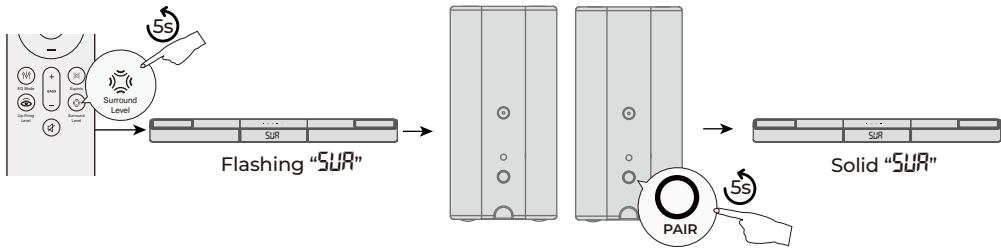

Normally, the Soundbar and Surround are pre-paired. If the connection is lost, please follow the steps below to re-pair them:

- 1 Press and hold the “Surround Level” button on the remote control for 5 seconds. The main unit display will flash “SUR” to indicate pairing mode.
- 2 Press and hold the pairing button on the back of the Surround for 5 seconds to enter pairing mode.
- 3 When pairing is successful, the main unit display will stop flashing and the subwoofer indicator light will remain steadily on.

16 RESTORE FACTORY SETTINGS

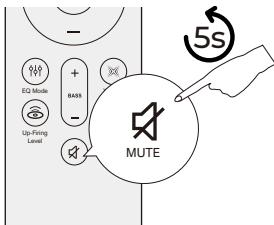

Press and hold the MUTE button for 5 seconds to restore factory settings

17 ADJUST PROMPT SOUND VOLUME

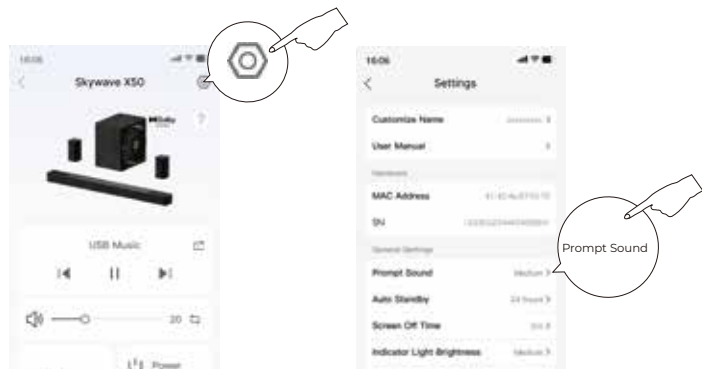

If you find the Soundbar's prompt tone too loud, you can adjust its volume through the ULTIMEA App.

- 1 Scan the QR code to download the ULTIMEA App, then add your Soundbar to the app.
- 2 Open the Soundbar's Device Details page, tap the Settings icon in the upper-right corner, and select “Prompt Sound Volume” Adjust the level as needed.

18 SPECIFICATIONS

Model Number	U422A
Power Supply	DC 18V--3.6A(Soundbar) / DC 18V--1.5A(Surround)/DC 30V--3A(Subwoofer)
Soundbar Drivers	Soundbar:2.25" x4 + 2.25" x 2 , Surround: 2.25" x 2 + 2.25" x2, Subwoofer: 8" x 1
Frequency Response	28Hz - 20kHz (-6dB)
Auto Standby	The soundbar will turn to standby mode if there is no audio signal for 15 minutes. You can set the standby time in the App
Standby Power	<0.5W
Operating Temperature	-10 C -45 C / 14°F -113°F
Bluetooth Version	5.4

Soundbar	1102 x 100 x 70 mm / 43.39" x 3.94" x 2.76"
Subwoofer	260 x 355 x 355 mm / 10.2" x 14.0" x 14.0"
Surround Speaker	85 x85 x 170 mm / 3.35" x 3.35" x 6.69"
Packaging	465 x 432 x 572 mm = 18.3" x 17.0" x 22.5"
Net Weight	14.34 kg / 31.6 lbs
Gross Weight	19.9 kg / 43.9 lbs

PROPER DISPOSAL INSTRUCTIONS



This mark shown on the product or its packaging, indicates that this product should not be disposed of with other household waste at the end of its working life. To prevent possible harm to the environment or human health from uncontrolled waste disposal, please separate this from other types of wastes and recycle it responsibly to promote the sustainable reuse of material resources.

WASTE ELECTRICAL & ELECTRONIC EQUIPMENT

Household user should contact either the retailer where they purchased this product, or their local government office, for details of where and how they can take this item for environmentally safe recycling.

Business users should contact their suppliers and check the terms and conditions of the purchase contract. This product should not be mixed with other commercial wastes for disposal.

WIRELESS FREQUENCY RANGE AND WIRELESS OUTPUT POWER:

Frequency: 2.402GHz-2.48GHz,5.8GHz

FCC REGULATORY COMPLIANCE

Any changes or modifications not expressly approved by the party responsible for compliance could void the user's authority to operate the equipment.

This device complies with Part 15 of the FCC Rules.

Operation is subject to the following two conditions:

(1) This device may not cause harmful interference.

(2) This device must accept any interference received, including interference that may cause undesired operation.

NOTE: This equipment has been tested and found to comply with the limits for a Class B digital device, pursuant to part 15 of the FCC Rules. These limits are designed to provide reasonable protection against harmful interference in a residential installation. This equipment generates, uses, and can radiate radio frequency energy, and if not installed and used in accordance with the instructions, may cause harmful interference to radio communications.

However, there is no guarantee that interference will not occur in a particular installation. If this equipment does cause harmful interference to radio or television reception, which can be determined by turning the equipment off and on, the user is encouraged to try to correct the interference by one or more of the following measures:

- Reorient or relocate the receiving antenna.

- Increase the separation between the equipment and the receiver.

- Connect the equipment to an outlet on a circuit different from that to which the receiver is connected.

- Consult the dealer or an experienced radio / TV technician for help.

This equipment complies with FCC radiation exposure limits set forth for an uncontrolled environment. This equipment should be installed and operated with a minimum distance of 20cm between the radiator & your body. This transmitter must not be co-located or operating in conjunction with any other antenna or transmitter.

ISED WARNINGS

This device contains licence-exempt transmitter (s) / receiver (s) that comply with Innovation, Science and Economic Development Canada's licence-exempt RSS (s). Operation is subject to the following two conditions:

(1) This device may not cause interference.

(2) This device must accept any interference, including interference that may cause undesired operation of the device.

L'émetteur/récepteur exempt de licence contenu dans le présent appareil est conforme aux CNR d'Innovation, Sciences et Développement économique Canada applicables aux appareils radio exempts de licence. L'exploitation est autorisée aux deux conditions suivantes:

(1) L'appareil ne doit pas produire de brouillage;

(2) L'appareil doit accepter tout brouillage radioélectrique subi, même si le brouillage est susceptible d'en compromettre le fonctionnement.

The device meets the exemption from the routine evaluation limits in section 2.5 of RSS 102 and compliance with RSS-102 RF exposure, users can obtain Canadian information on RF exposure and compliance.

Le dispositif rencontre l'exemption des limites courantes d'évaluation dans la section 2.5 de RSS 102 et la conformité à l'exposition de RSS-102 rf, utilisateurs peut obtenir l'information canadienne sur l'exposition et la conformité de rf.

This transmitter must not be co-located or operating in conjunction with any other antenna or transmitter. This

equipment should be installed and operated with a minimum distance of 20 centimeters between the radiator and your body. Cet émetteur ne doit pas être Co-placé ou ne fonctionnant en même temps qu'aucune autre antenne ou émetteur. Cet équipement devrait être installé et actionné avec une distance minimum de 20 centimètres entre le radiateur et votre corps.

CE WARNINGS

1) Do not install this equipment in a confined or building-in space such as a book case or similar unit, and remain a well ventilation conditions.

The ventilation should not be impeded by covering the ventilation openings with items such as newspaper, table-cloths, curtains etc.

2) WARNING: To reduce the risk of fire or electric shock, do not expose this apparatus to rain or moisture. The apparatus shall not be exposed to dripping or splashing and that objects filled with liquids, such as vases, shall not be placed on apparatus.

3) WARNING: The adapter plug is used as disconnect device, the disconnect device shall remain readily operable.

4) Frequency: 2.402GHz-2.48GHz,5.8GHz

5) The Max. transmit power: 13.03 dBm

Wireless Capability Description:

The subwoofer and two surround speakers connect wirelessly but function solely as signal receivers without relaying or forwarding data.

The remote control uses infrared (IR) technology for device operation and does not support other wireless transmission or reception.

An IR transmitter on the rear of the Soundbar is used exclusively to relay remote control signals and does not support any other wireless communication.

⚠ WARNING: This product can expose you to chemicals including lead, which is known to the State of California to cause cancer and birth defects or other reproductive harm. For more information, go to www.P65Warnings.ca.gov.

Safety Instructions

(1) Please read and keep these instructions. Follow all warnings and instructions.

(2) Do not use the device near water, in damp environments, or in the rain. Avoid liquid spills and do not place objects containing liquids (such as vases) on the device.

(3) Clean only with a dry cloth. Do not use liquid cleaners.

(4) Do not block ventilation openings or install the device in a confined space. Ensure proper ventilation according to the manufacturer's instructions.

(5) Do not install the device near heat sources such as radiators, stoves, or amplifiers, and do not cover the ventilation openings with items like newspapers or curtains.

(6) Use only attachments, stands, or accessories specified by the manufacturer. Be cautious when moving the device on wheels to prevent tipping.

(7) Protect the power cord from being walked on, pinched, or bent, especially at plugs, convenience receptacles, and the point where they exit from the device.

(8) Do not modify the polarized or grounding-type plug. If the plug does not fit into your outlet, consult an electrician to replace the outlet.

(9) Unplug the device during lightning storms or when unused for long periods. To completely disconnect the device, unplug it from the power outlet and ensure the plug is easily accessible.

(10) Do not place any open flame sources, such as lit candles, on the device.

(11) Do not attempt to open the device. There is a risk of dangerous high voltage. No user-serviceable parts inside. All servicing must be carried out by qualified personnel.

(12) The installation height of the device must not exceed 2 meters.



More safety info via QR code
Weitere Sicherheitshinweise per QR-Code
QRコードで安全情報を見る

Trade Marks:



Dolby, Dolby Atmos, and the double-D symbol are registered trademarks of Dolby Laboratories Licensing Corporation. Manufactured under license from Dolby Laboratories. Confidential unpublished works. Copyright © 2012–2024 Dolby Laboratories. All rights reserved.



The Bluetooth word mark and logos are registered trademarks owned by Bluetooth SIG, Inc. and any use of such marks by Ultimea Technology (Shenzhen) Limited, is under license. Other trademarks and trade names are those of their respective owners.



The terms HDMI, HDMI High-Definition Multimedia Interface, HDMI trade dress and the HDMI Logos are trademarks or registered trademarks of HDMI Licensing Administrator, Inc.

EU DECLARATION OF CONFORMITY

We (Manufacturer is responsible for this declaration) Ultimea Technology (Shenzhen) Limited 20th Floor, Building 4, Tianan Cloud Park, Bantian St., Longgang District Shenzhen, China 518000

Declare under our sole responsibility that the product

Trade Mark: ULTIMEA

Product Name: Soundbar

Model No.: U422A

The product to which this declaration relates is in conformity with the essential requirements set out in the Council Directive on the Approximation of the laws of the Member States relating to the Radio Equipment Directive (2014/53/EU), the Restriction of Hazardous Substances Directive (2011/65/EU), the Electromagnetic Compatibility Directive (2014/30/EU), and the Low Voltage Directive (2014/35/EU). The product is responsible for affixing the CE marking, and the following standards were applied:

EN 55032:2015/A1:2020	IEC 62321-3-1:2013	Full Name: Yoyo.Yu
EN 55035:2017/A1:2020	IEC 62321-4:2013+A1:2017	Position: Approval Manager
EN IEC 61000-3-2:2019/A2:2024	IEC 62321-5:2013	Signature: <i>yoyo yu</i>
EN 61000-3-3:2013/A2:2021	IEC 62321-6:2015	Place/Date: Shenzhen, China / July 20, 2025
ETSI EN 301 489-1 V2.2.3 (2019-11)	IEC 62321-7-1:2015	
ETSI EN 301 489-17 V3.2.4 (2020-09)	IEC 62321-7-2:2017	
ETSI EN 300 328 V2.2.2 (2019-07)	IEC 62321-8:2017	
EN IEC 62311:2020	ETSI EN 301 489-3 V2.3.2(2023-01)	
EN IEC 62368-1:2020+A11:2020	ETSI EN 300 440 V2.2.1(2018-07)	

EC REP Ultimea GmbH Buchenring 57, 22359 Hamburg, Germany

UK REP EVATOST CONSULTING LTD Office 101 32 Threadneedle Street, London, United Kingdom, EC2R 8AY

@Ultimea Inc. All rights reserved, registered in the United States and other countries. 9804 Crescent Center Drive, Suite 604, Rancho Cucamonga, CA 91730

Made in China
Manufacturer: Ultimea Technology (Shenzhen) Limited
Address: 20th Floor, Building 4, Tianan Cloud Park, Bantian St., Longgang District, Shenzhen, China 518000

Manufacturer Contact Information:

+1 888-598-8875 (US) support@ultimea.com
Mon-Fri 9am-5pm (PST)
+49 89-628-25828 (EU) support.ultimea.com
Mon-Fri 9am-5pm (CET)



If you need our support, kindly reach out to our service team. We are always glad to help.

