

**ULTIMEA**

**HDMI™**

**Bluetooth®**



# ***User Manual***

**Apollo S70**

**EN:** User Manual

**FR:** Manuel de l'Utilisateur

**DE:** Benutzerhandbuch

**IT:** Manuale d'uso

**JP:** ユーザーマニュアル

**ES:** Manual del usuario

Model No.: U3700

Apollo S70 5.0 Channel Detachable Lighting Soundbar



# Contents

01	User Manual	English
	Connection and Installation .....	03
07	Benutzerhandbuch	Deutsch
	Anschluss und Installation .....	09
13	ユーザーマニュアル	日本語
	接続と設置 .....	15
19	Mode d'Emploi	Français
	Raccordement et installation .....	21
25	Manuale d'uso	Italiano
	Connessione e installazione .....	27
26	Manual del usuario	Español
	Conexión e instalación .....	33





# User Manual



Model No.: U3700

WE ARE  
READY  
TO HELP



support@ultimea.com  
support.ultimea.com

Scan code to  
download app

You can also search for "ULTIMEA" on Google Play or Apple Store to download the app.



@ultimea\_official

+1 888-598-8875 (US) Mon-Fri 9am-5pm (PST)  
+49 89-628-25828 (EU) Mon-Fri 9am-5pm (CET)



## 1 ACCESSORIES LIST



Left Unit & Right Unit



Center Unit



Power Adaptor

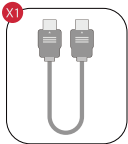

HDMI Cable

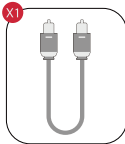

Digital Optical Cable

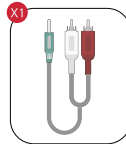

Stereo 3.5mm to RCA Audio Cable

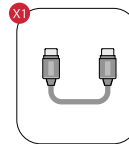

4-pin Cable for Soundbar Connection(100mm)

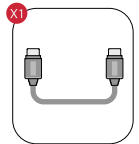

4-pin Cable for Soundbar Connection(180mm)

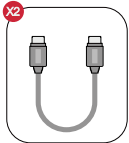

4-pin Cable for Soundbar Connection(2m)

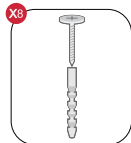

Wall Mounting Kit

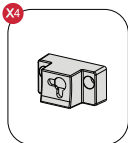

Wall Bracket



Remote Control

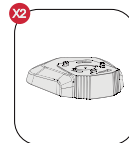

Base

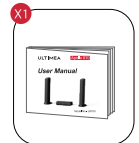

User Manual



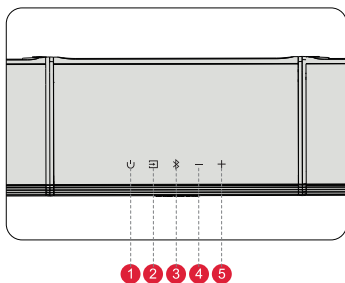



















## 2 SOUNDBAR CONTROLS



### Control Panel

- 1 "⏻": **Power Button**  
Press to power on / off.
- 2 "📺": **Source**  
Press to switch channels: ARC-OPT(OPTICAL)-BT-AUX-USB.
- 3 "📶": **Bluetooth**  
Press to switch to BT channel and enter pairing mode. Hold for 3 seconds to disconnect current device and choose to connect to a new device manually on your mobile phone / PC / TV (BT ID: Apollo S70).
- 4 "⏮": **Volume Down**
- 5 "⏭": **Volume Up**

## Remote Control

- 1 “”: **Power Button**  
Press to power on / off.
- 2 “”: **SOURCE**  
Press to switch channel: ARC-OPT-BT-AUX-USB
- 3 “”: **ARC**  
Press to switch to HDMI ARC channel.
- 4 “”: **OPT**  
Press to switch to OPTICAL channel.
- 5 “”: **AUX**  
Press to switch to AUX channel.
- 6 “”: **BT**  
Press to switch to BLUETOOTH channel.
- 7 “”: **USB**  
Press to switch to USB channel.
- 8 “”: **INFO**  
Press to view status information: Software version;  
EQ; Bass/Midrange/Treble;
- 9 “”: **USB REPEAT**  
USB mode: Press to switch between single loop playback and list loop playback.
- 10 “+”: **Volume Up**
- 11 “-”: **Volume Down**
- 12 “<”: **Previous**  
For BT and USB mode only: Skip to previous track.
- 13 “>”: **Next**  
For BT and USB mode only: Skip to next track.
- 14 “”: **Play / Pause**  
For BT and USB mode only.
- 15 “”: **MUTE**
- 16 “”: **LED DIMMER**  
Press to adjust display brightness in 5 levels. Press and hold for 3s to turn off the LED display.
- 17 “”: **BASSMAX™**  
Press to adjust bass level, the display will show: “B5-6”, “B5-5”, “B5-4”, “B5-3”, “B5-2”, “B5-1”, “B5 0”, “B5 1”, “B5 2”, “B5 3”, “B5 4”, “B5 5”, “B5 6”.
- 18 “”: **MIDRANGE**  
Press to adjust alto level, the display will show: “MR-6”, “MR-5”, “MR-4”, “MR-3”, “MR-2”, “MR-1”, “MR 0”, “MR 1”, “MR 2”, “MR 3”, “MR 4”, “MR 5”, “MR 6”.
- 19 “”: **TREBLE**  
Press to adjust treble level, the display will show: “T3-6”, “T3-5”, “T3-4”, “T3-3”, “T3-2”, “T3-1”, “T3 0”, “T3 1”, “T3 2”, “T3 3”, “T3 4”, “T3 5”, “T3 6”.
- 20 “”: **MOVIE**  
Press to switch to MOVIE mode, the display will show: “MOVI”.
- 21 “”: **MUSIC**  
Press to switch to MUSIC mode, the display will show: “MUSC”.
- 22 “”: **VOICE**  
Press to switch to VOICE mode, the display will show: “VOIC”.
- 23 “”: **SPORT**  
Press to switch to SPORT mode, the display will show: “SPRT”.
- 24 “”: **GAME**  
Press to switch to GAME mode, the display will show: “GAME”.
- 25 “”: **NIGHT**  
Press to switch to NIGHT mode, the display will show: “NIGT”.
- 26 “”: **PROMPT TONE**  
Press to adjust prompt tone level, the display will show: “PT 0”, “PT 1”, “PT 2”, “PT 3”.
- 27 “”: **RGB LIGHTING**  
Press “+” or “-” to adjust the brightness of RGB lighting effects, Short press the middle button to turn on and switch the lighting effect mode, long press for 3 seconds to turn off the lighting effect.

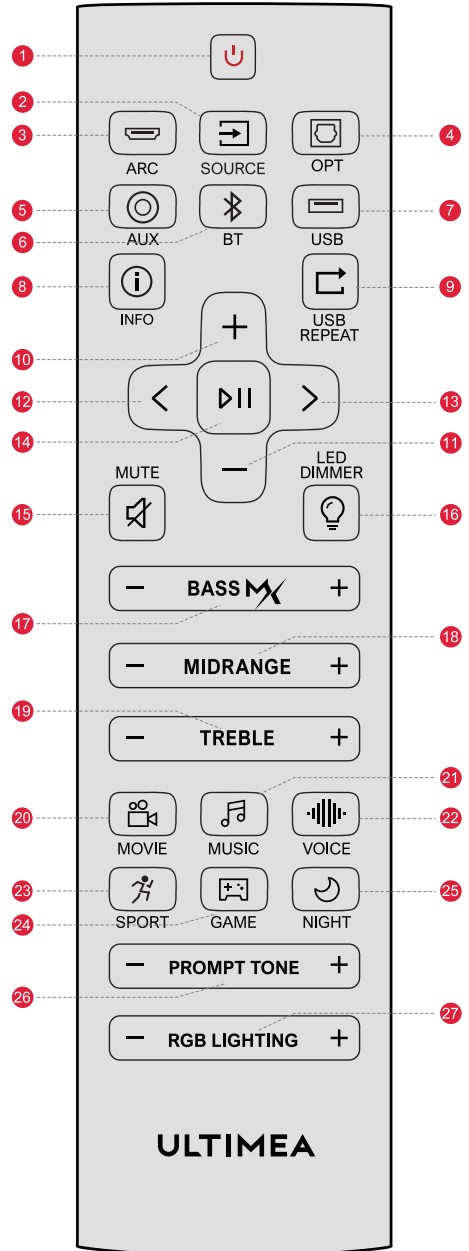

## 3 SOUNDBAR INSTALLATION

EN

### Detached and stand on base:

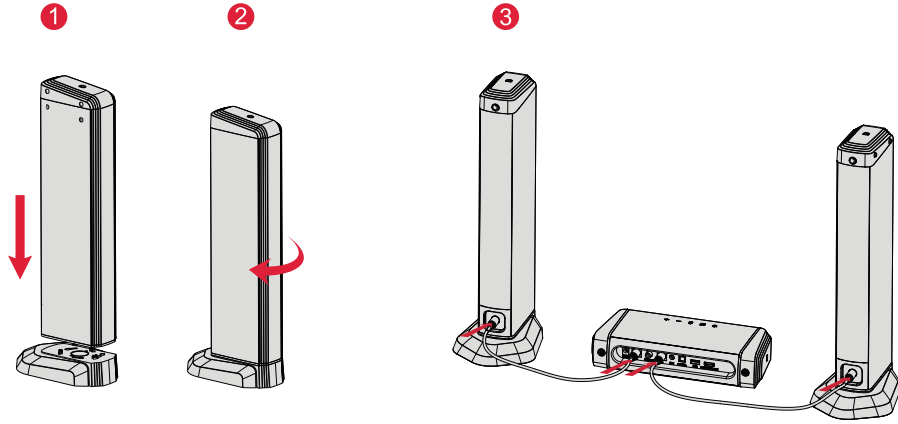

- 1 Set the soundbar on the base and align the joints.
- 2 Twist to connect with the base.
- 3 Plug in the 4-pin Cable (Cable 1 & Cable 2) for Soundbar Connection.

Note: When connecting the cable, the red terminal is plugged into the red port and the white terminal is plugged into the white port.

### Horizontal placement:

- 1 Remove the covers on both sides of the host.

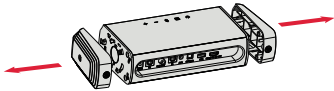

- 2 Align the joints of the three parts.



- 3 Twist to connect.

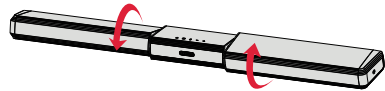

- 4 Plug in the 4-pin Cable (Cable 3 & Cable 4) for Soundbar Connection.

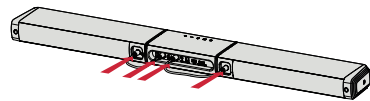

## 4 REAR PANEL

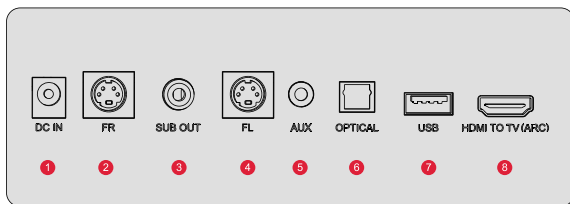

- 1 DC IN
- 2 FR: FRONT RIGHT  
Used to connect the auxiliary machine on the right
- 3 SUB OUT  
Connect to active subwoofer (Not Included)
- 4 FL: FRONT LEFT  
Used to connect the auxiliary machine on the left
- 5 AUX
- 6 OPTICAL
- 7 USB  
Support MP3 file with 128G max memory
- 8 HDMI TO TV(ARC)



## 5 CONNECT TO TV VIA HDMI OUT ARC

EN

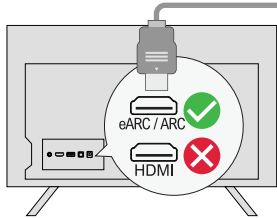

### Step 1:

Connect one end of the HDMI cable to the eARC / ARC port on the back of your TV.

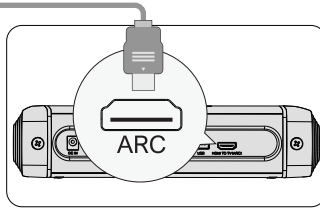

### Step 2:

Then connect the other end into the ARC port of the soundbar.

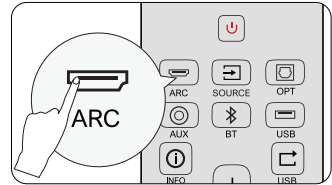

### Step 3:

Press "ARC" button on the remote control to select "ARC" input.

**If there is no sound, try setting the TV audio output to PCM:**

TV Settings > Home > Settings > Sound > Digital Audio Output > PCM

**Note: Please turn on the "CEC" function on your TV.**

When eARC / ARC is connected, your TV remote control can control the soundbar and TV simultaneously:

- ❶ Turn on / off
- ❷ Adjust the volume

## 6 CONNECT TO TV VIA OPTICAL / AUX

### OPTICAL

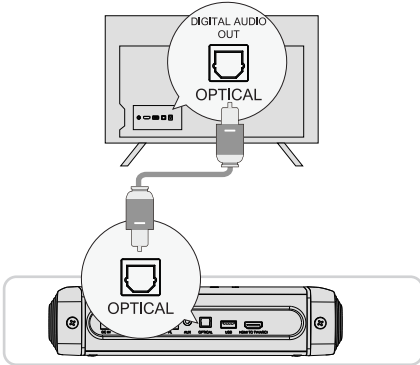

#### OPTION 1: OPTICAL

- ❶ Make sure the TV's port is OPTICAL OUT, connect both sides of the cable to OPTICAL, for both the TV and the soundbar.
- ❷ Make sure the optical plug is inserted correctly as it shows in the picture. Do not insert the plug upside down and break the optical.

**Note:** If audio is coming from the internal TV speakers, mute or minimize the TV volume.

### AUX

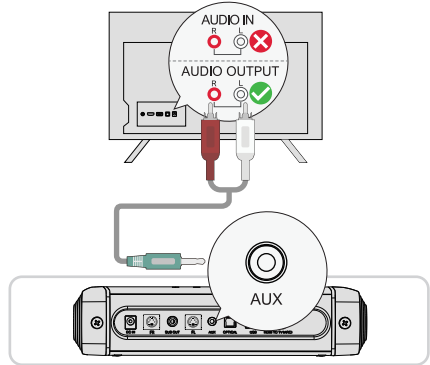

#### OPTION 2: AUX

- ❶ Connect the 3.5mm RCA audio cable to connect to your TV's RCA AUDIO OUT port.
- ❷ Make sure the color of the cables ends matches the color of the TV ports.

**Note:** Please remember to unplug the AUX cable from TV and Soundbar when you want to switch other mode.

**In Optical Mode:** If there is no sound, try setting the TV audio output to PCM: TV Settings > Home > Settings > Sound > Digital Audio Output > PCM

## 7 CONNECT TO BLUETOOTH®

- ❶ Press the "Bluetooth" button on the soundbar or press the "Bluetooth" button on the remote control to enter Bluetooth pairing mode.
- ❷ Go to the Bluetooth setting on your phone, find and select "Apollo S70" to connect the soundbar.

**Note:** If it's already in the Bluetooth mode and connected, press and hold "Bluetooth" button for 3 seconds to disconnect current device and choose to connect to a new device manually on your mobile phone / PC / TV.

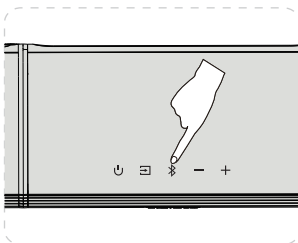

or

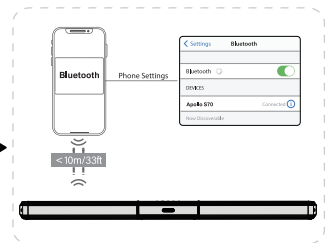
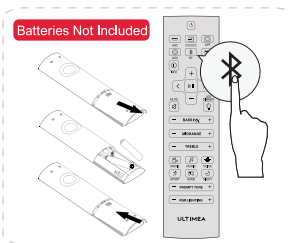

Detached and stand on base

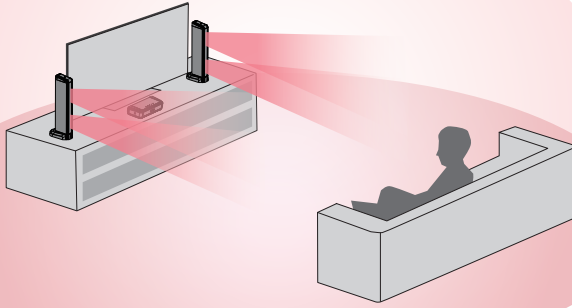

Horizontal placement

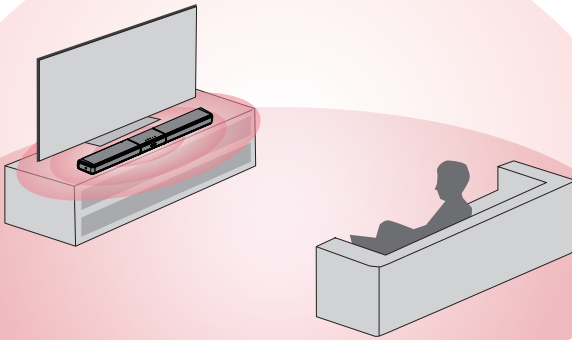

**Note:** The soundbar should be placed at or near ear level.

9 WALL MOUNT INSTALLATION

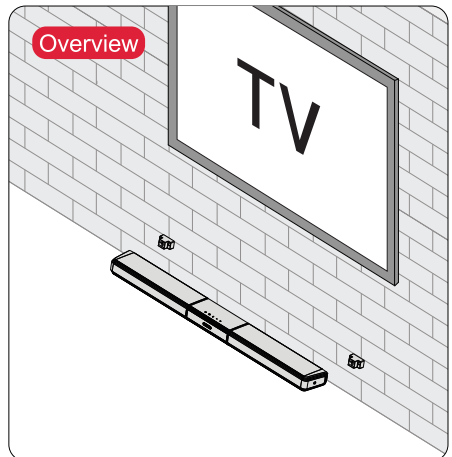
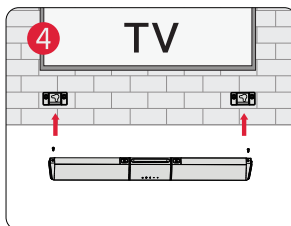
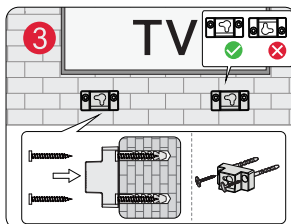
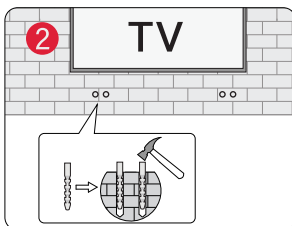
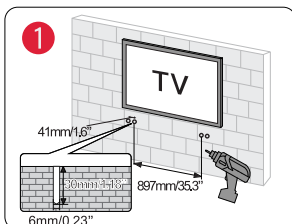

<b>Model Number</b>	U3700
<b>Power Supply</b>	AC 100 - 240V, ~50/60Hz
<b>Soundbar Drivers</b>	2.25"x 5 (Soundbar)
<b>Frequency Response</b>	55Hz - 18kHz
<b>Standby Power</b>	<0.5W
<b>Operating Temperature</b>	0°C - 45°C / 32°F - 113°F
<b>Bluetooth Vision</b>	5.3

<b>Dimensions and Weight</b>	
<b>Soundbar</b>	977 (W) × 110 (D) × 58 (H)    38.5" × 4.3" × 2.3"
<b>Packaging</b>	440 (W) × 195 (D) × 290 (H)    17.3" × 7.7" × 11.4"
<b>Net Weight</b>	3.0kg / 6.61lb
<b>Gross Weight</b>	4.2kg / 9.26lb

# Benutzerhandbuch



Modell Nr.: U3700

WIR SIND  
BEREIT ZU  
HILFEN



support@ultimea.com  
support.ultimea.com

Code scannen, um  
App herunterzuladen



Sie können auch nach "ULTIMEA" auf  
Google Play oder im Apple Store  
suchen, um die App herunterzuladen



@ultimea\_official

+1 888-598-8875 (US) Mon-Fri 9am-5pm (PST)  
+49 89-628-25828 (EU) Mon-Fri 9am-5pm (CET)

## 1 ZUBEHÖRLISTE



Linkes Untermodule & Rechtes Untermodule



Zentraleinheit



Netzadapter

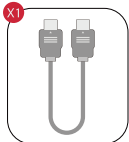

HDMI-Kabel

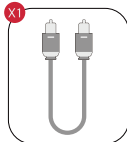

Optisches Digitalkabel

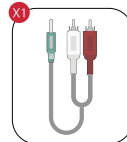

Stereo 3,5mm auf RCA  
Audiokabel

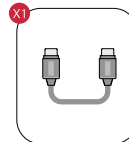

4-poliges Kabel für  
die Verbindung mit  
der Soundbar (100 mm)

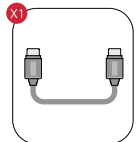

4-poliges Kabel für die  
Verbindung mit  
der Soundbar (180 mm)

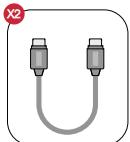

4-poliges Kabel für die  
Verbindung mit  
der Soundbar (2 m)

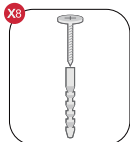

Wandmontiertes Kit

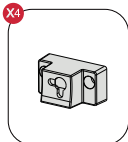

Wandhalterung



Fernsteuerung

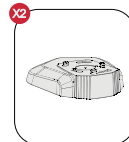

Basis



Benutzerhandbuch

## 2 BEDIENELEMENTE FÜR DIE SOUNDBAR

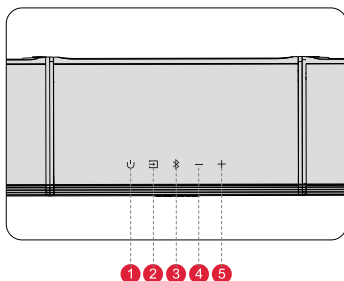

### Bedienfeld

- 1 "⏻": **Einschalttaste**  
Drücken Sie die Ein-/Aus-Taste zum Ein-/Ausschalten.
- 2 "📺": **QUELLE**  
Drücken Sie diese Taste, um die Kanäle zu wechseln:  
ARC-OPT(OPTISCH)-BT-AUX-USB.
- 3 "📶": **Bluetooth**  
Drücken Sie diese Taste, um zum BT-Kanal zu wechseln und den  
Kopplungsmodus zu aktivieren.  
Halten Sie die Taste 3 Sekunden lang gedrückt, um die Verbindung  
zum aktuellen Gerät zu trennen und manuell eine Verbindung zu  
einem neuen Gerät auf Ihrem Mobiltelefon/PC/Fernseher  
herzustellen (BT-ID: Apollo S70).
- 4 "🔊": **Lautstärke leiser**
- 5 "🔊": **Lauter**

## Fernsteuerung

- 1 "U": **Einschalttaste**  
Drücken Sie diese Taste, um das Gerät ein- und auszuschalten.
- 2 "☰": **Quelle**  
Drücken Sie diese Taste, um die Kanäle zu wechseln:  
ARC-OPT(OPTISCH)-BT-AUX-USB.
- 3 "≡": **ARC**  
Drücken Sie diese Taste, um zum HDMI ARC-Kanal zu wechseln.
- 4 "☐": **OPT**  
Drücken Sie diese Taste, um zum OPTICAL-Kanal zu wechseln.
- 5 "◎": **AUX**  
Drücken Sie diese Taste, um zum AUX-Kanal zu wechseln.
- 6 "⌘": **BT**  
Drücken, um zum BLUETOOTH-Kanal zu wechseln.
- 7 "≡": **USB**  
Drücken, um zum USB-Kanal zu wechseln.
- 8 "ⓘ": **INFORMATION**  
Drücken Sie, um Statusinformationen anzuzeigen:  
Softwareversion; EQ; Bass/Mittel/Höhen;
- 9 "⏮": **USB REPEAT**  
USB-Modus: Drücken Sie diese Taste, um zwischen  
Einzelschleifenwiedergabe und Listenschleifenwiedergabe zu wechseln.
- 10 "+": **Lautstärke erhöhen**
- 11 "-": **Lautstärke verringern**
- 12 "<": **Zurück**  
Nur im BT- und USB-Modus: Springt zum vorherigen Titel.
- 13 ">": **Weiter**  
Nur im BT- und USB-Modus: Zum nächsten Titel springen.
- 14 "⏮": **Wiedergabe/Pause**  
Nur für den BT- und USB-Modus.
- 15 "🔇": **MUTE**
- 16 "💡": **LED-DIMMER**  
Drücken, um die Helligkeit des Displays in 5 Stufen einzustellen.  
Halten Sie die Taste 3 Sekunden lang gedrückt, um das Display  
auszuschalten.
- 17 "BASS MAX": **BASSMAX™**  
Drücken Sie diese Taste, um den Basspegel einzustellen. Auf dem  
Display wird angezeigt: "B5-6", "B5-5", "B5-4", "B5-3", "B5-2",  
"B5-1", "B5 0", "B5 1", "B5 2", "B5 3", "B5 4", "B5 5", "B5 6".
- 18 "MIDRANGE": **MITTELTONBEREICH**  
Drücken Sie diese Taste, um den Alt-Pegel einzustellen. Auf dem  
Display erscheint: "MR-6", "MR-5", "MR-4", "MR-3", "MR-2", "MR-1",  
"MR 0", "MR 1", "MR 2", "MR 3", "MR 4", "MR 5", "MR 6".
- 19 "TREBLE": **TREBLE**  
Drücken Sie diese Taste, um die Höhen einzustellen. Auf dem  
Display erscheint: "TJ-6", "TJ-5", "TJ-4", "TJ-3", "TJ-2", "TJ-1",  
"TJ 0", "TJ 1", "TJ 2", "TJ 3", "TJ 4", "TJ 5", "TJ 6".
- 20 "🎬": **MOVIE**  
Drücken Sie diese Taste, um in den MOVIE-Modus zu wechseln, auf dem Display erscheint: "MOVIE".
- 21 "🎵": **MUSIK**  
Drücken Sie diese Taste, um in den MUSIC-Modus zu wechseln, auf dem Display erscheint: "MUSIC".
- 22 "🗣️": **STIMME**  
Drücken Sie diese Taste, um in den VOICE-Modus zu wechseln; auf dem Display erscheint: "VOICE".
- 23 "🏃": **SPORT**  
Drücken Sie diese Taste, um in den SPORT-Modus zu wechseln, auf dem Display erscheint: "SPORT".
- 24 "🎮": **SPIEL**  
Drücken Sie diese Taste, um in den GAME-Modus zu wechseln; auf dem Display erscheint: "GAME".
- 25 "🌙": **NACHT**  
Drücken Sie diese Taste, um in den NIGHT-Modus zu wechseln, auf dem Display erscheint: "NIGHT".
- 26 "PROMPT TONE": **AUFFORDERUNGSTON**  
Drücken Sie diese Taste, um den Souffleur-Ton einzustellen, auf dem Display erscheint: "PT 0", "PT 1", "PT 2", "PT 3".
- 27 "RGB LIGHTING": **RGB-BELEUCHTUNG**  
Drücken Sie "+" oder "-", um die Helligkeit der RGB-Beleuchtungseffekte anzupassen. Kurzes Drücken der  
mittleren Taste zum Einschalten und Wechseln des Beleuchtungsmodus, langes Drücken für 3 Sekunden zum  
Ausschalten des Beleuchtungseffekts.

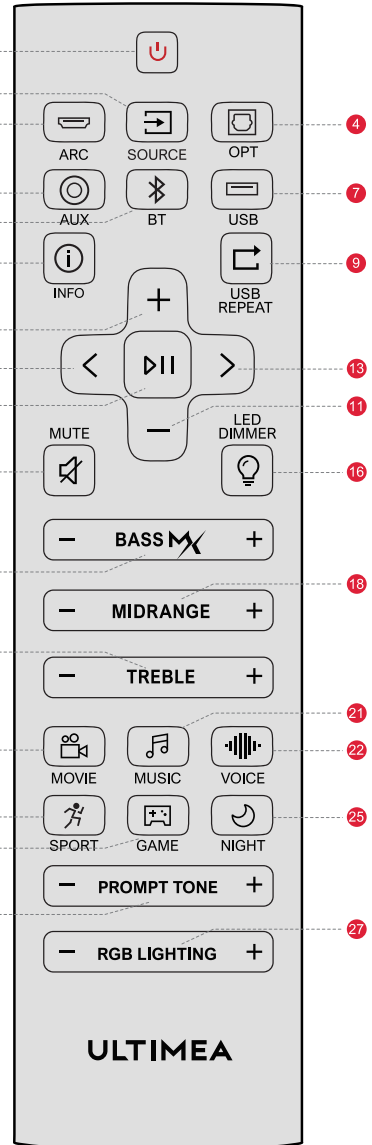



## Losgelöst und auf Sockel stehend:

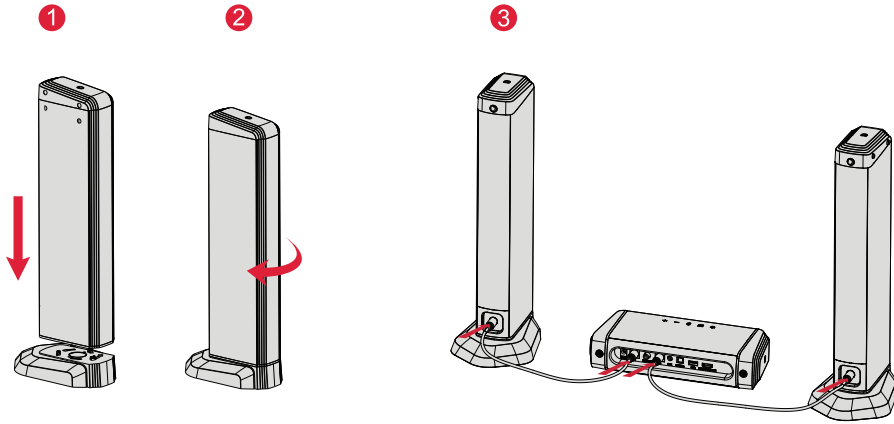

- 1 Setzen Sie die Soundbar auf die Basis und richten Sie die Gelenke aus.
- 2 Drehen Sie, um mit der Basis zu verbinden.
- 3 Stecken Sie das 4-polige Kabel (Kabel 1 & Kabel 2) für die Soundbar-Verbindung ein.  
Hinweis: Beim Anschließen des Kabels wird der rote Stecker in den roten Anschluss und der weiße Stecker in den weißen Anschluss gesteckt.

## Horizontale Platzierung:

- 1 Entfernen Sie die Abdeckungen auf beiden Seiten des Hosts.

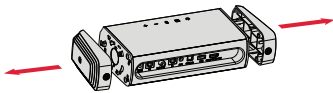

- 2 Richten Sie die Gelenke der drei Teile aus.



- 3 Drehen Sie zum Verbinden.



- 4 Stecken Sie das 4-polige Kabel (Kabel 3 & Kabel 4) für die Soundbar-Verbindung ein.

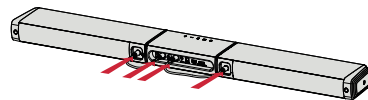

# 4 RÜCKPANEL

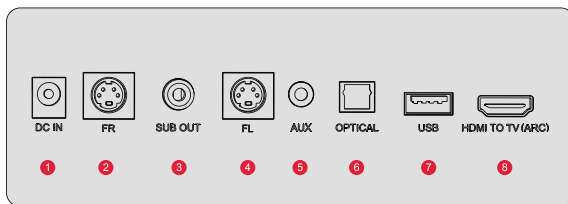

- 1 **DC IN**
- 2 **FR: FRONT RIGHT**  
Wird verwendet, um die Hilfsmaschine auf der rechten Seite anzuschließen.
- 3 **SUB OUT**  
Anschluss an aktiven Subwoofer (nicht enthalten)
- 4 **FL: FRONT LEFT**  
Wird verwendet, um die Hilfsmaschine auf der linken Seite anzuschließen.
- 5 **AUX**
- 6 **OPTISCH**
- 7 **USB**  
Unterstützt MP3-Dateien mit maximal 128 GB Speicher
- 8 **HDMI ZUM FERNSEHER (ARC)**

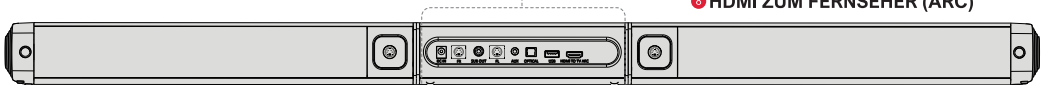

## 5 ANSCHLUSS AN FERNSEHER ÜBER ARC

DE

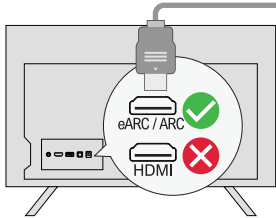

### Schritt 1:

Verbinden Sie ein Ende des HDMI-Kabels mit dem eARC / ARC-Anschluss auf der Rückseite Ihres Fernsehers.

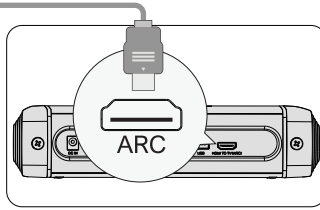

### Schritt 2:

Schließen Sie dann das andere Ende an den ARC-Anschluss der Soundbar an.

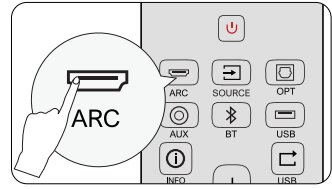

### Schritt 3:

Drücken Sie die "ARC"-Taste auf der Fernbedienung, um den "ARC"-Eingang auszuwählen.

**Wenn kein Ton zu hören ist: Versuchen Sie, den TV-Audioausgang auf PCM einzustellen:**

TV-Einstellungen > Home > Einstellungen > Ton > Digitaler Audioausgang > PCM

**Hinweis: Bitte schalten Sie die "CEC"-Funktion an Ihrem Fernsehgerät ein.**

Wenn ARC angeschlossen ist, kann Ihre TV-Fernbedienung die Soundbar und den Fernseher gleichzeitig steuern:

- 1 Einschalten/Ausschalten
- 2 Lautstärke einstellen

## 6 ANSCHLUSS AN FERNSEHER ÜBER OPTISCH / AUX

### OPTISCH

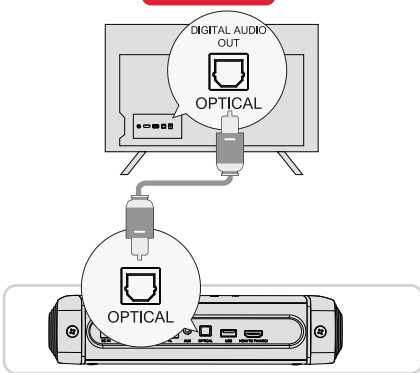

#### OPTION 1: OPTISCH

### AUX

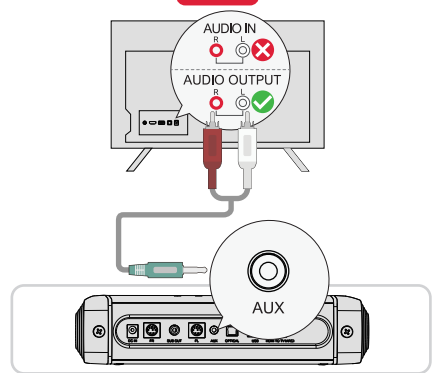

#### OPTION 2: AUX

- 1 Vergewissern Sie sich, dass der Anschluss des Fernsehers auf OPTICAL OUT eingestellt ist, und verbinden Sie beide Seiten des Kabels mit OPTICAL, sowohl für den Fernseher als auch für die Soundbar.
  - 2 Vergewissern Sie sich, dass der optische Stecker richtig eingesteckt ist, wie auf dem Bild zu sehen. Stecken Sie den Stecker nicht verkehrt herum ein, um das optische Kabel nicht zu beschädigen.
- Hinweis:** Wenn der Ton über die internen Lautsprecher des Fernsehers wiedergegeben wird, schalten Sie die Lautstärke des Fernsehers stumm oder verringern Sie sie.

- 1 Schließen Sie das 3,5-mm-Cinch-Audiokabel an den RCA-AUDIO OUT-Anschluss Ihres Fernsehers an.
  - 2 Achten Sie darauf, dass die Farbe der Kabelenden mit der Farbe der TV-Anschlüsse übereinstimmt.
- Hinweis:** Bitte denken Sie daran, das AUX-Kabel vom Fernseher und der Soundbar zu trennen, wenn Sie den Modus wechseln möchten.

**Im optischen Modus: Wenn kein Ton zu hören ist, versuchen Sie, den TV-Audioausgang auf PCM einzustellen:**

TV-Einstellungen > Home > Einstellungen > Ton > Digitaler Audioausgang > PCM.

## 7 VERBINDEN MIT BLUETOOTH®

- 1 Drücken Sie die Taste "Bluetooth" auf der Soundbar oder der Fernbedienung, um den Bluetooth-Kopplungsmodus zu aktivieren.
- 2 Öffnen Sie die Bluetooth-Einstellungen Ihres Telefons, suchen Sie "Apollo S70" und wählen Sie es aus, um die Soundbar zu verbinden.

**Hinweis:** Wenn sich die Soundbar bereits im Bluetooth-Modus befindet und verbunden ist, halten Sie die Taste "Bluetooth" 3 Sekunden lang gedrückt, um die Verbindung mit dem aktuellen Gerät zu trennen und das neue Gerät manuell auf Ihrem Mobiltelefon / PC / Fernseher zu verbinden.

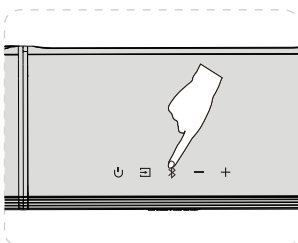

or

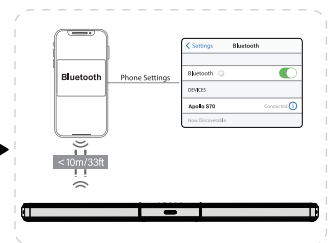
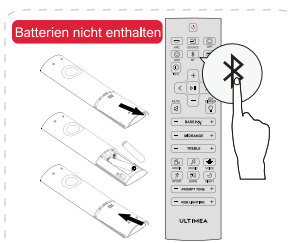

## 8 AUFSTELLUNGSOPTIONEN

DE

### Losgelöst und auf Sockel stehend

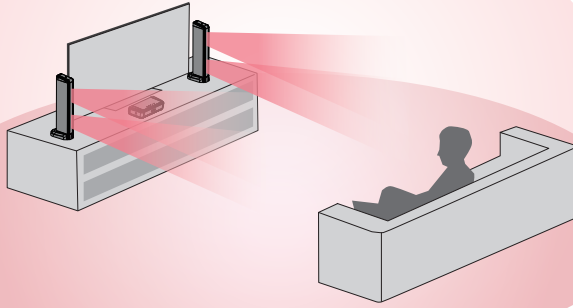

### Horizontale Platzierung

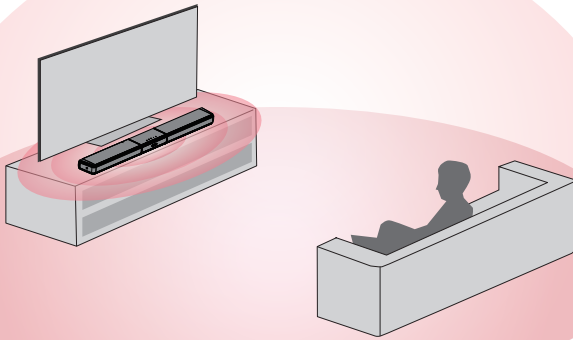

**Hinweis:** Für ein besseres Hörerlebnis sollten Sie das gesamte System wie in der Abbildung oben dargestellt aufstellen.

## 9 WANDMONTAGE

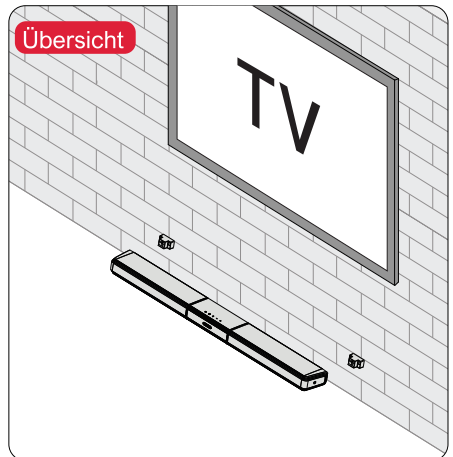
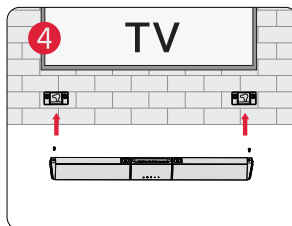
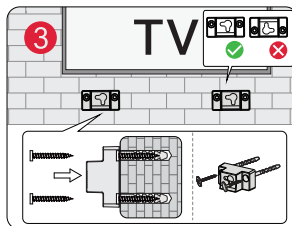
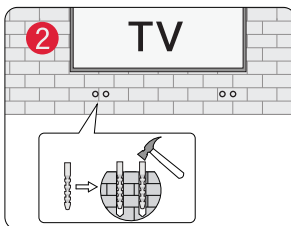
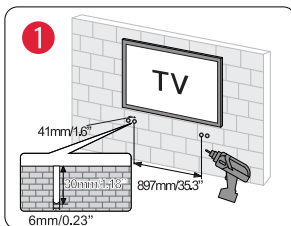

<b>Modell Nummer</b>	U3700
<b>Stromversorgung</b>	AC 100 - 240V, ~50/60Hz
<b>Soundbar-Treiber</b>	2.25" x 5 (Soundbar)
<b>Frequenzgang</b>	55Hz - 18kHz
<b>Standby-Leistung</b>	<0.5W
<b>Betriebstemperatur</b>	0°C - 45°C / 32°F - 113°F
<b>Bluetooth-Version</b>	5.3

<b>Abmessungen und Gewicht</b>	
<b>Soundbar</b>	977 (W) × 110 (D) × 58 (H)    38.5" × 4.3" × 2.3"
<b>Verpackung</b>	440 (W) × 195 (D) × 290 (H)    17.3" × 7.7" × 11.4"
<b>Nettogewicht</b>	3.0kg / 6.61lb
<b>Bruttogewicht</b>	4.2kg / 9.26lb

ULTIMEA

Apollo S70

# ユーザー取扱説明書



モデル番号: U3700

うちにご支援  
させていただ  
く準備が整い  
ております。



support@ultimea.com  
support.ultimea.com

JP

コードをスキャンして  
アプリをダウンロード



またはGoogle PlayやApple Storeで  
"ULTIMEA"を検索してください。  
アプリのダウンロード



@ultimea\_official

+1 888-598-8875 (US) Mon-Fri 9am-5pm (PST)  
+49 89-628-25828 (EU) Mon-Fri 9am-5pm (CET)

## 1 付属品リスト



左ユニットと右ユニット



センターユニット



電源アダプター

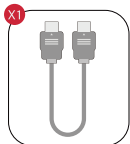

HDMIケーブル

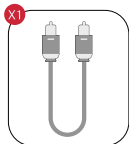

光デジタルケーブル

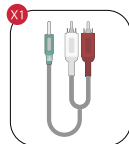

3.5mm - RCA  
オーディオケーブル

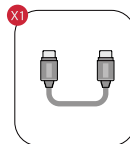

サウンドバー接続用  
4pinコード (100 mm)

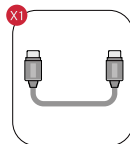

サウンドバー接続用  
4pinコード (180 mm)

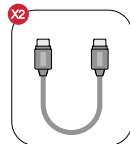

サウンドバー接続用  
4pinコード (2m)

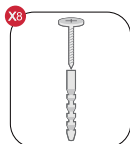

壁掛けネジキット

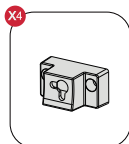

壁掛け固定スタンド



リモコン

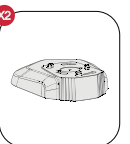

固定用ベース





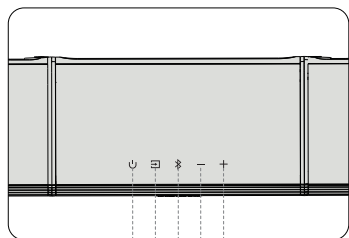

ユーザーマニュアル

## 2 サウンドバーコントロール





















1 2 3 4 5

### コントロールパネル

- ① “”: 電源ボタン  
電源ボタンを押すと、オン/オフが切り替わります。
- ② “”: 入力ソース  
一回押してチャンネルを切り替え: ARC-OPT(optical)-BT-AUX-USB.
- ③ “”: Bluetooth  
一回押してBTチャンネルに切り替え、ペアリングモードに入ります。  
3秒間長押しすると、現在のデバイスが切断され、スマホ/パソコン/TVに手動で接続されている新しいデバイス (BT ID: Apollo S70) が選択されます。
- ④ “”: ボリュームダウン
- ⑤ “”: ボリュームアップ

## リモコン

- 1 “”: **電源ボタン**  
一回押すと電源がオン/オフ
- 2 “”: **入力ソース**  
一回押してチャンネルを切り替え: arc-opt (optical)-bt-aux-usb.
- 3 “”: **ARC**  
一回押すとHDMI ARC に切り替え
- 4 “”: **OPT**  
一回押すとOPTICAL に切り替え
- 5 “”: **AUX**  
一回押すと AUX に切り替え
- 6 “”: **BT**  
一回押すとBLUETOOTH に切り替え
- 7 “”: **USB**  
一回押すと USB に切り替え
- 8 “”: **INFO**  
押すと現在の情報が表示され: ソフトウェアバージョン、EQ、低音/中音/高音。
- 9 “”: **USBリピート**  
USBモード: 一回押すと、ワンループ再生とリストループ再生に切り替え
- 10 “+”: **ボリュームアップ**
- 11 “-”: **ボリュームダウン**
- 12 “<”: **前**  
BTおよびUSBモードのみ: 前の曲へスキップ
- 13 “>”: **次へ**  
BTおよびUSBモードのみ: 次の曲へスキップ
- 14 “”: **再生/一時停止**  
BTおよびUSBモードのみ
- 15 “”: **ミュート**
- 16 “”: **LEDディマー**  
一回押すと5段階でディスプレイの明るさを調節でき3秒間押すと消灯する
- 17 “**BASS MAX**”: **BASSMAX**  
ディスプレイは: “B5-6”, “B5-5”, “B5-4”, “B5-3”, “B5-2”, “B5-1”, “B5 0”, “B5 1”, “B5 2”, “B5 3”, “B5 4”, “B5 5”, “B5 6”.
- 18 “**MIDRANGE**”: **ミッドレンジ**  
ディスプレイには: “MR-6”, “MR-5”, “MR-4”, “MR-3”, “MR-2”, “MR-1”, “MR 0”, “MR 1”, “MR 2”, “MR 3”, “MR 4”, “MR 5”, “MR 6”.
- 19 “**TREBLE**”: **TREBLE**  
ディスプレイには: “TJ-6”, “TJ-5”, “TJ-4”, “TJ-3”, “TJ-2”, “TJ-1”, “TJ 0”, “TJ 1”, “TJ 2”, “TJ 3”, “TJ 4”, “TJ 5”, “TJ 6”.
- 20 “”: **MOVIE**  
押すとモードに切り替わり: ディスプレイにMOVIと表示され
- 21 “”: **MUSIC**  
押すとモードに切り替わり: ディスプレイにMUSCと表示され
- 22 “”: **VOICE**  
押すとモードに切り替わり: ディスプレイにVOICと表示され
- 23 “”: **SPORT**  
押すとモードに切り替わり: ディスプレイにSPRTと表示され
- 24 “”: **GAME**  
押すとモードに切り替わり: ディスプレイにGAMEと表示され
- 25 “”: **NIGHT**  
押すとモードに切り替わり: ディスプレイにNIGTと表示され
- 26 “**PROMPT TONE**”: **プロンプトトーン**  
プロンプトトーンレベル調整: “PT 0”, “PT 1”, “PT 2”, “PT 3”.
- 27 “**RGB LIGHTING**”: **RGB ライティング**  
RGBライト効果の明るさを調整するには、“+”または“-”を押します。中央のボタンを短押しして点灯させ、ライト効果モードを切り替え、3秒間長押しして消灯させます。

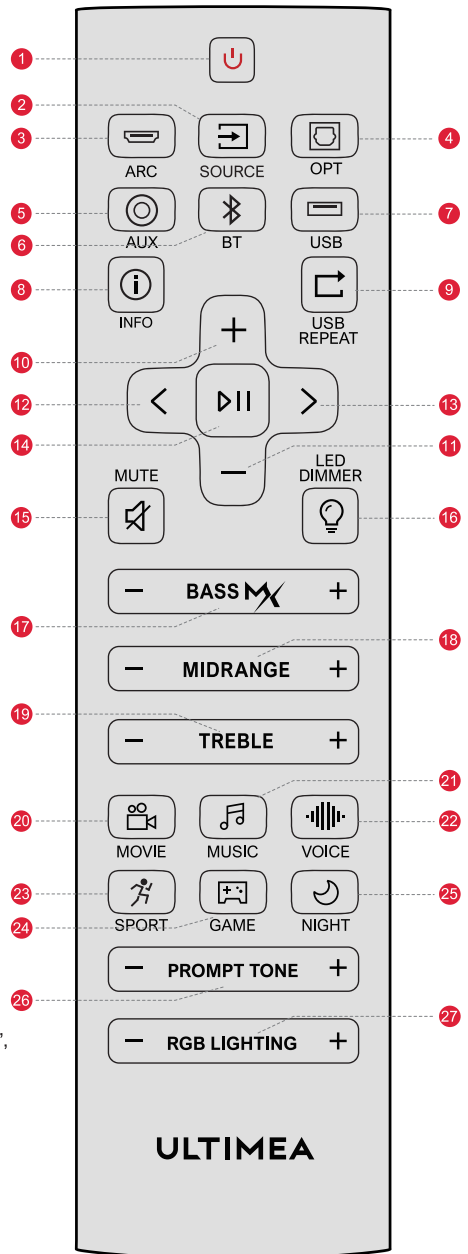

### 3 サウンドバーの設置

JP

取り外して台座に立てる:

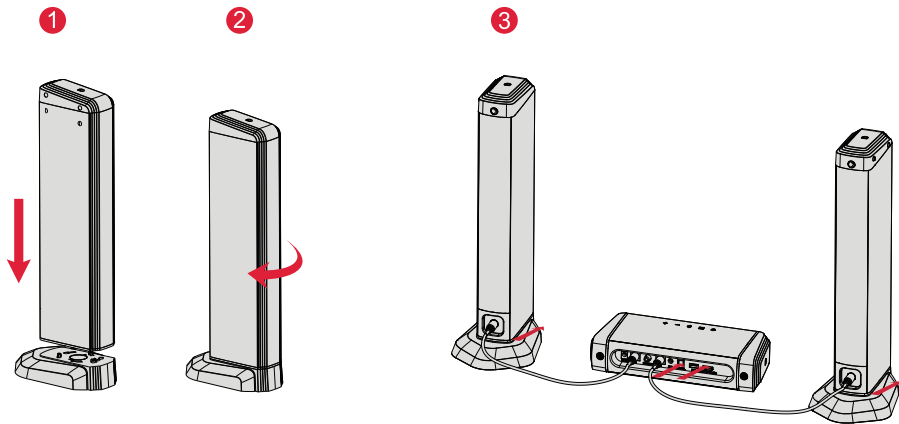

- ① サウンドバーを台座に設置し、接続部分を合わせます。
- ② 台座と接続するためにねじめます。
- ③ サウンドバー接続用の4ピンケーブル（ケーブル1&ケーブル2）を差し込みます。  
注：コードをつなぐ際は、赤い端子を赤のポートに、白い端子を白のポートに差し込みます。

横置き:

- ① ホストの両側のカバーを取り外します。
- ② 3つのパーツ接続部分を合わせます。
- ③ 接続するためにねじめます。
- ④ サウンドバー接続用の4ピンケーブル（ケーブル3&ケーブル4）を差し込みます。

### 4 背面パネル

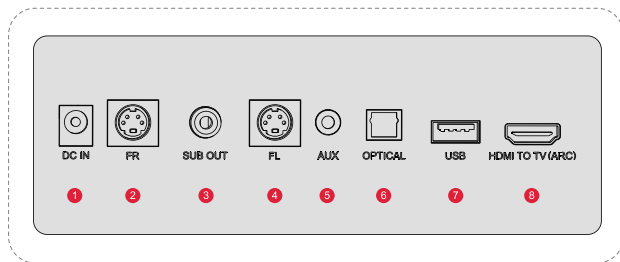

- ① DC 入力
- ② FR: 右 フロント  
右側の補助機器に接続するために使用します。
- ③ SUB OUT  
サブウーファーを接続可能（別売）。
- ④ FL: 左 フロント  
左側の補助装置に接続用。
- ⑤ AUX
- ⑥ OPTICAL
- ⑦ USB  
最大容量128GのMP3ファイルを再生可能。
- ⑧ HDMI TO TV (ARC)



## 5 HDMI ARC経由でテレビに接続

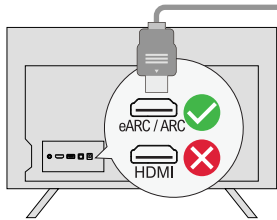

**ステップ1:**  
HDMIケーブルの一端をテレビのeARC/  
ARCポートに接続します。

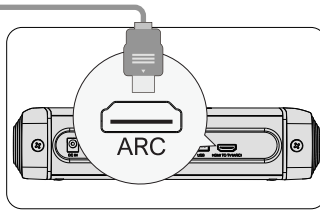

**ステップ2:**  
もう一方の端子をサウンドバーのARCポ  
ートに接続します。

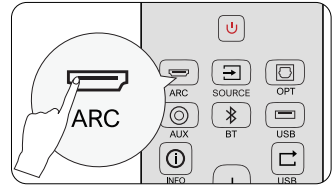

**ステップ3:**  
リモコンの「ARC」ボタンを押して「ARC  
」入力を選択します。

注: テレビの「CEC」機能をオンにしてください。

ARCを接続すると、テレビのリモコンでサウンドバーとテレビを同時に操作できます:

① スイッチのオン/オフで ② 音量を調整する

音が出ない場合: テレビの音声出力をPCMに設定してみてください: テレビの設定 > ホーム > 設定 > サウンド > デジタル音声出力 > PCM

## 6 オプティカル/AUXでテレビに接続

### OPTICAL

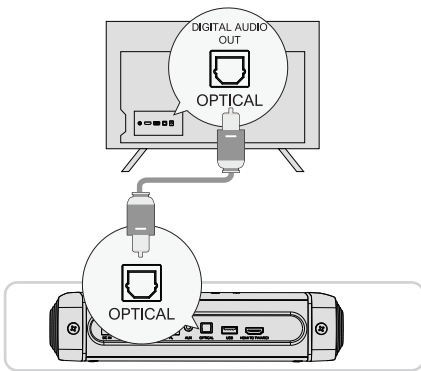

#### 接続方法 1: OPTICAL

① テレビとサウンドバーからのケーブルの両端をOPTICALポートに接続し、テレビのポートがOPTICAL OUTであることを確認します。  
② 光プラグが図のように正しく差し込まれていることを確認してください。光ファイバーが断線する恐れがあるため、プラグを逆に差し込まないでください。  
注: テレビの内蔵スピーカーから音声が再生されている場合は、テレビの音量をミュートまたは最小にしてください。

### AUX

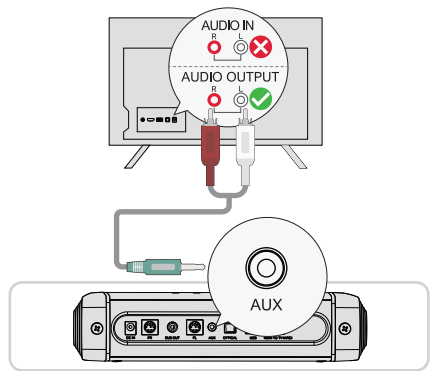

#### 接続方法 2: AUX

① 3.5mmオーディオケーブルをテレビのRCA AUDIO OUTポートに接続します。  
② ケーブルの端の色がテレビのポートの色と一致していることを確認してください。  
注: 他のモードに切り替える場合は、テレビとサウンドバーからAUXケーブルを抜いてください。

オプティカルモードの場合: 音が出ない場合は、テレビの音声出力をPCMに設定してみてください:  
TV Setup > Home > Settings > Sound > Digital Audio Output > PCM

## 7 Bluetoothへの接続\*

- ① スピーカーまたはリモコンの"⌘"ボタンを押して、Bluetoothペアリングモードに入ります。
- ② 携帯電話のBluetooth設定を開き、"Apollo S70"を見つけて選択し、スピーカーに接続します。

注: Bluetoothモードに入って接続した場合は、"⌘"ボタンを3秒間長押しして現在のデバイスを切断し、携帯電話/コンピュータ/テレビで新しいデバイスに手動で接続してください。

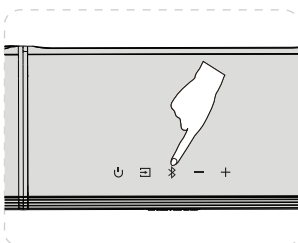

or

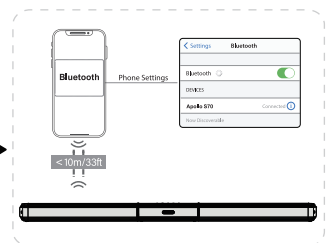
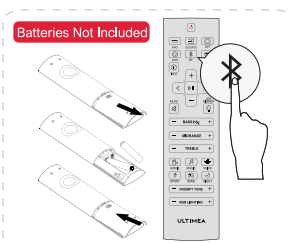



取り外して台座に立てる

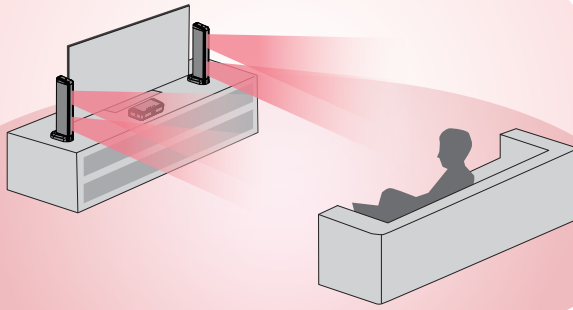

横置き

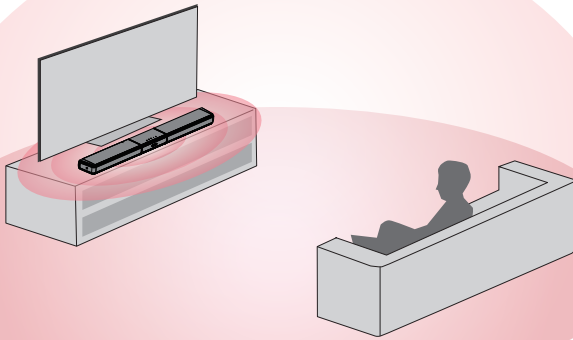

注: より良いリスニング体験のために、システム全体を図のように配置してください。

9 壁掛け設置

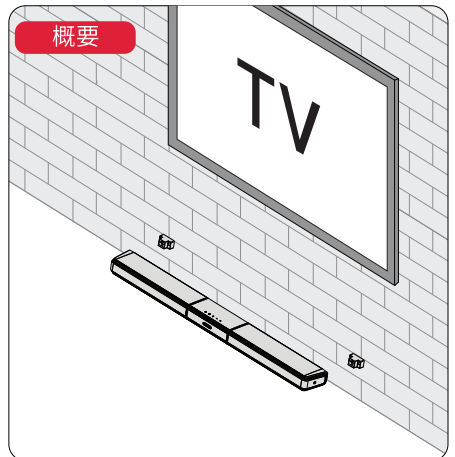
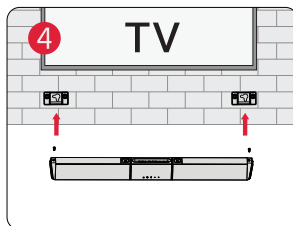
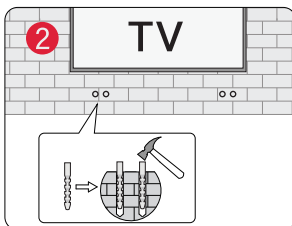
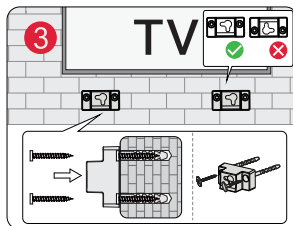
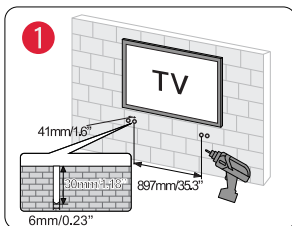

モデル番号	U3700
電源供給	AC 100 - 240V, ~50/60Hz
サウンドボードドライバー	2.25ch x 5 (サウンドバー)
周波数帯域	55Hz - 18kHz
待機電力	<0.5W
動作温度	0°C - 45°C / 32°F - 113°F
Bluetoothバージョン	5.3

寸法と重量	
サウンドバー	977 (W) × 110 (D) × 58 (H)    38.5" × 4.3" × 2.3"
包装	440 (W) × 195 (D) × 290 (H)    17.3" × 7.7" × 11.4"
正味重量	3.0kg / 6.61lb
総重量	4.2kg / 9.26lb

ULTIMEA

Apollo S70

# Manuel d'utilisation

## NOUS SOMMES PRÊTS À VOUS AIDER



support@ultimea.com  
support.ultimea.com



Numéro de modèle: U3700

### Scanner le code pour télécharger l'application

Vous pouvez également rechercher "ULTIMEA" sur Google Play ou Apple Store pour télécharger l'application.



@ultimea\_official

+1 888-598-8875 (US) Mon-Fri 9am-5pm (PST)  
+49 89-628-25828 (EU) Mon-Fri 9am-5pm (CET)

FR

## 1 LISTE DES ACCESSOIRES



Unité de gauche et unité de droite



Unité centrale



Adaptateur d'alimentation

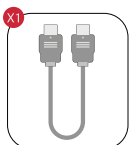

Câble HDMI

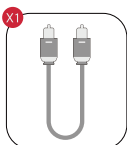

Câble optique numérique

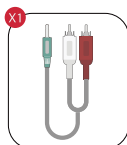

Câble audio stéréo RCA vers 3,5 mm

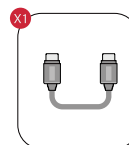

Câble à 4 broches pour connexion à la barre de son (100 mm)

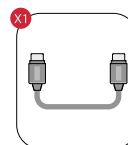

Câble à 4 broches pour connexion à la barre de son (180 mm)

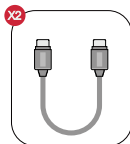

Câble à 4 broches pour connexion à la barre de son (2 m)

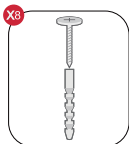

Kit de montage mural

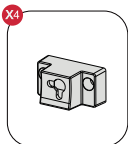

Support mural



Télécommande

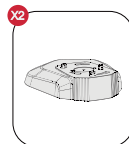

Socle



Manuel de l'utilisateur

## 2 COMMANDES DE LA BARRE DE SON

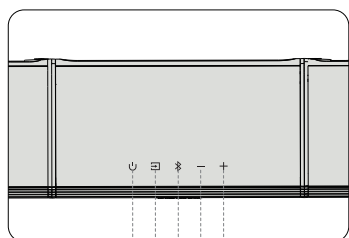

### Panneau de contrôle

- 1 "⏻": Bouton d'alimentation**  
Appuyez sur le bouton d'alimentation pour allumer/éteindre.
- 2 "📺": Source**  
Appuyez sur ce bouton pour changer de canal : ARC-OPT(OPTICAL)-BT-AUX-USB.
- 3 "📶": Bluetooth**  
Appuyez sur cette touche pour passer au canal BT et entrer en mode d'appairage.  
Maintenez cette touche enfoncée pendant 3 secondes pour déconnecter l'appareil actuel et choisir de vous connecter manuellement à un nouvel appareil sur votre téléphone portable / PC / TV (BT ID : Apollo S70).
- 4 "⏮": Réduction du volume**
- 5 "⏭": Augmentation du volume**

## Télécommande

- 1 "⏻": **Bouton d'alimentation**  
Appuyez pour allumer/éteindre.
- 2 "☰": **SOURCE**  
Appuyez sur ce bouton pour changer de canal : ARC-OPT(OPTICAL)-BT-AUX-USB.
- 3 "≡": **ARC**  
Appuyez pour basculer vers le canal HDMI ARC.
- 4 "◻": **OPT**  
Appuyez pour basculer vers le canal OPTIQUE.
- 5 "⊙": **AUX**  
Appuyez pour basculer vers le canal AUX.
- 6 "⌘": **BT**  
Appuyez pour basculer vers le canal BLUETOOTH.
- 7 "≡": **USB**  
Appuyez pour basculer vers le canal USB.
- 8 "ⓘ": **INFO**  
Appuyez pour afficher les informations sur l'état : Version du logiciel ; EQ ; Basses/Médiums/Aigus.
- 9 "↺": **RÉPÉTITION USB**  
Mode USB : Appuyez pour basculer entre la lecture en boucle simple et la lecture en boucle de liste.
- 10 "+": **Augmentation du volume**
- 11 "-": **Réduction du volume**
- 12 "<": **Précédent**  
Uniquement pour les modes BT et USB : Passer à la piste précédente.
- 13 ">": **Suivant**  
Uniquement pour les modes BT et USB : Passer à la piste suivante.
- 14 "⏮": **Lecture / Pause**  
Uniquement pour les modes BT et USB.
- 15 "🔇": **MUTE**
- 16 "💡": **Atténuateur LED**  
Appuyez pour ajuster la luminosité de l'affichage sur 5 niveaux. Appuyez et maintenez pendant 3 secondes pour éteindre l'affichage.
- 17 "BASS MAX": **BASSMAX**  
Appuyez pour ajuster le niveau des basses, l'affichage indiquera: "B5-6", "B5-5", "B5-4", "B5-3", "B5-2", "B5-1", "B5 0", "B5 1", "B5 2", "B5 3", "B5 4", "B5 5", "B5 6".
- 18 "MIDRANGE": **MIDRANGE**  
Appuyez pour ajuster le niveau des médiums, l'affichage indiquera: "MR-6", "MR-5", "MR-4", "MR-3", "MR-2", "MR-1", "MR 0", "MR 1", "MR 2", "MR 3", "MR 4", "MR 5", "MR 6".
- 19 "TREBLE": **TREBLE**  
Appuyez pour ajuster le niveau des aigus, l'affichage indiquera: "TB-6", "TB-5", "TB-4", "TB-3", "TB-2", "TB-1", "TB 0", "TB 1", "TB 2", "TB 3", "TB 4", "TB 5", "TB 6".
- 20 "🎬": **FILM**  
Appuyez pour basculer en mode MOVIE, l'affichage indiquera: "MOVI".
- 21 "🎵": **MUSIQUE**  
Appuyez pour basculer en mode MUSIC, l'affichage indiquera: "MUSIC".
- 22 "🔊": **VOIX**  
Appuyez pour basculer en mode VOICE, l'affichage indiquera: "VOICE".
- 23 "🏃": **SPORT**  
Appuyez pour basculer en mode SPORT, l'affichage indiquera: "SPRT".
- 24 "🎮": **JEU**  
Appuyez pour basculer en mode GAME, l'affichage indiquera: "GAME".
- 25 "🌙": **NUIT**  
Appuyez pour basculer en mode NIGHT, l'affichage indiquera: "NIGT".
- 26 "PROMPT TONE": **TONALITÉ D'INVITE**  
Appuyez pour ajuster le niveau de la tonalité de l'invite, l'affichage indiquera: "PT 0", "PT 1", "PT 2", "PT 3".
- 27 "RGB LIGHTING": **ÉCLAIRAGE RGB**  
Appuyez sur "+" ou "-" pour ajuster la luminosité des effets d'éclairage RGB. Appuyez brièvement sur le bouton central pour allumer et changer le mode d'effet lumineux, maintenez enfoncé pendant 3 secondes pour éteindre l'effet lumineux.

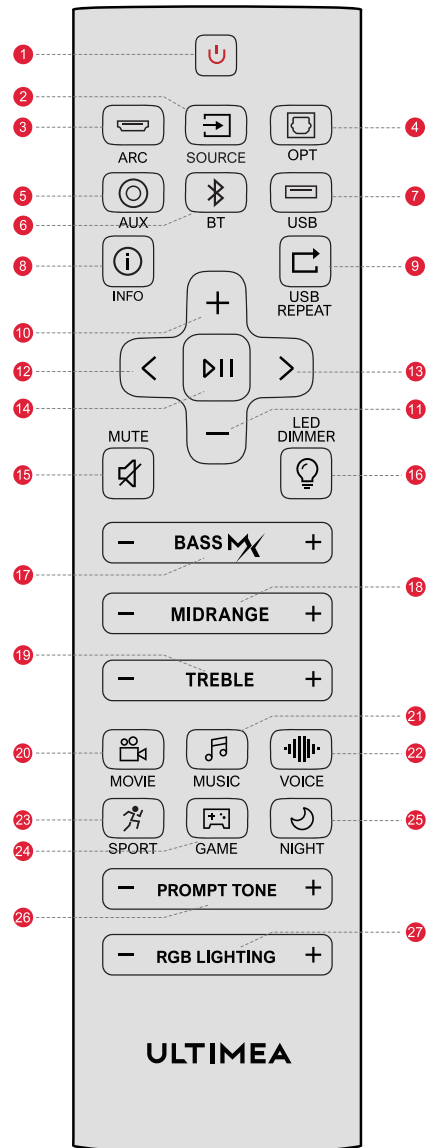

## 3 INSTALLATION DE LA BARRE DE SON

### Détacher et se tenir sur la base :

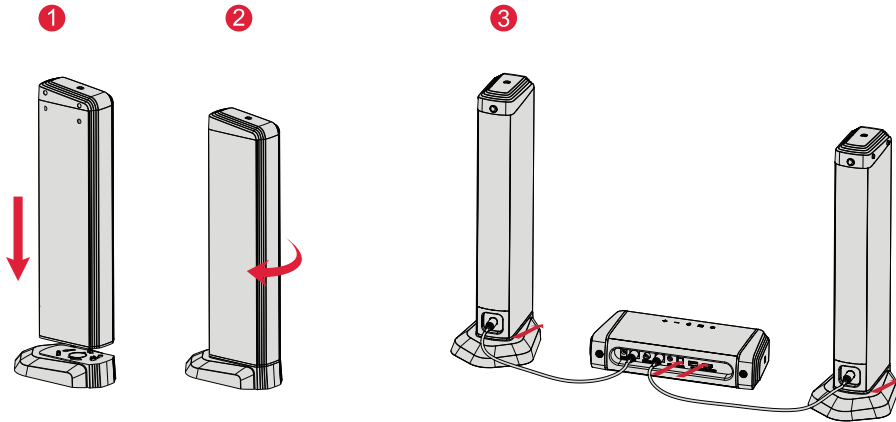

- 1 Placez la barre de son sur la base et alignez les joints.
- 2 Tournez pour connecter avec la base.
- 3 Branchez le câble à 4 broches (Câble 1 & Câble 2) pour la connexion de la barre de son.

Remarque : Lors du branchement du câble, la rouge est branchée dans le port rouge et la borne blanche est branchée dans le port blanc.

### Placement horizontal :

- 1 Retirez les couvercles des deux côtés de l'unité principale.

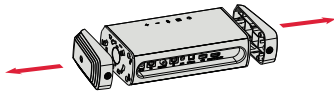

- 2 Alignez les joints des trois parties.



- 3 Tournez pour connecter.



- 4 Branchez le câble à 4 broches (Câble 3 & Câble 4) pour la connexion de la barre de son.

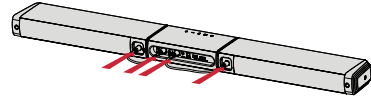

## 4 PANNEAU ARRIÈRE

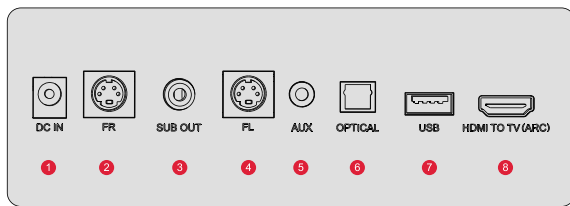

### 1 DC IN

### 2 FR: FRONT RIGHT

Utilisé pour connecter la machine auxiliaire sur la droite

### 3 SUB OUT

Connectez-vous à un caisson de basses actif (non inclus)

### 4 FL: FRONT LEFT

Utilisé pour connecter la machine auxiliaire sur la gauche.

### 5 AUX

### 6 OPTIQUE

### 7 USB

Prise en charge des fichiers MP3 avec une mémoire maximale de 128 Go

### 8 HDMI VERS TV (ARC)

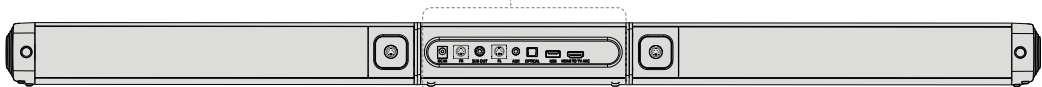

## 5 CONNECTER AU TÉLÉVISEUR VIA ARC

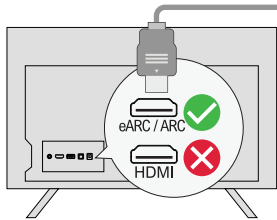

### Étape 1:

Connectez une extrémité du câble HDMI au port eARC / ARC de votre téléviseur.

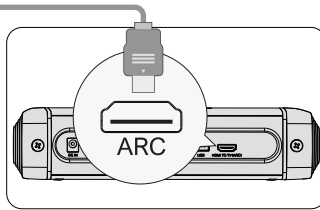

### Étape 2:

Connectez ensuite l'autre extrémité au port ARC de la barre de son.

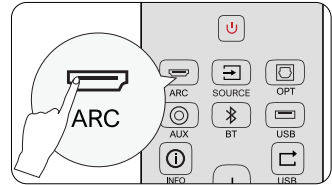

### Étape 3:

Appuyez sur la touche "ARC" de la télécommande pour sélectionner l'entrée "ARC".

**Remarque :** Activez la fonction "CEC" sur votre téléviseur.

Lorsque l'entrée ARC est connectée, la télécommande de votre téléviseur peut contrôler simultanément la barre de son et le téléviseur :

- 1 Allumer/éteindre
- 2 Régler le volume

**S'il n'y a pas de son :** essayez de régler la sortie audio du téléviseur sur PCM : Réglages du téléviseur > Accueil > Réglages > Son > Sortie audio numérique > PCM

## 6 CONNEXION AU TÉLÉVISEUR VIA OPTIQUE / AUX

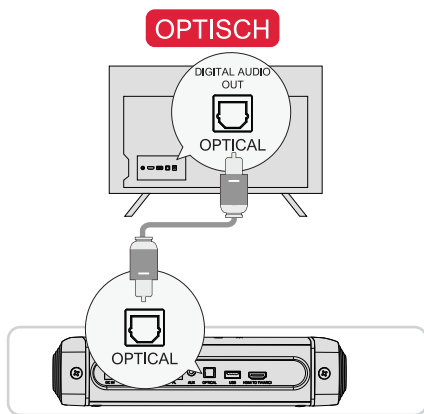

### OPTION 1 : OPTIQUE

- 1 Assurez-vous que le port du téléviseur est OPTICAL OUT, connectez les deux côtés du câble à OPTICAL, à la fois pour le téléviseur et la barre de son.
- 2 Assurez-vous que la prise optique est insérée correctement, comme indiqué sur l'image. N'insérez pas la fiche à l'envers et ne cassez pas le câble optique.

**Remarque :** si le son est diffusé par les haut-parleurs internes du téléviseur, mettez le volume du téléviseur en sourdine ou réduisez-le au minimum.

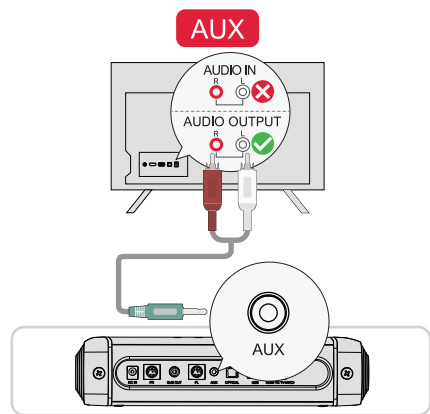

### OPTION 2: AUX

- 1 Connectez le câble audio 3.5 mm vers RCA au port RCA AUDIO OUT de votre téléviseur.
- 2 Assurez-vous que la couleur des extrémités du câble correspond à la couleur des ports du téléviseur.

**Remarque :** N'oubliez pas de débrancher le câble AUX de la télévision et de la barre de son lorsque vous souhaitez passer à un autre mode.

**En mode optique :** S'il n'y a pas de son, essayez de régler la sortie audio du téléviseur sur PCM : Réglages du téléviseur > Accueil > Réglages > Son > Sortie audio numérique > PCM

## 7 CONNEXION AU BLUETOOTH®

- 1 Appuyez sur le bouton "Bluetooth" de la barre de son ou de la télécommande pour entrer dans le mode d'appairage Bluetooth.
- 2 Ouvrez les paramètres Bluetooth de votre téléphone, trouvez et sélectionnez "Apollo S70" pour connecter la barre de son.

**Remarque :** si la barre de son est déjà en mode Bluetooth et connectée, appuyez sur le bouton "Bluetooth" et maintenez-le enfoncé pendant 3 secondes pour déconnecter l'appareil actuel et connecter le nouvel appareil manuellement sur votre téléphone portable / PC / TV.

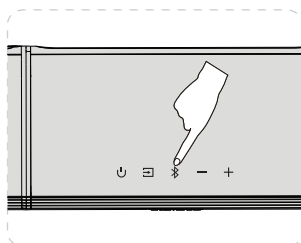

or

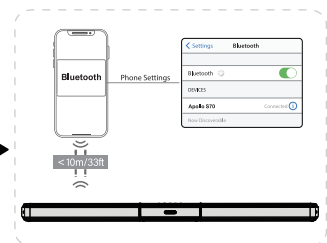
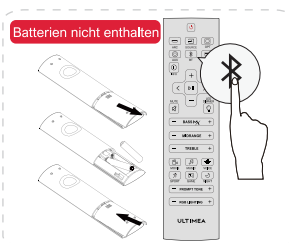

## 8 OPTIONS DE PLACEMENT

FR

### Détacher et se tenir sur la base

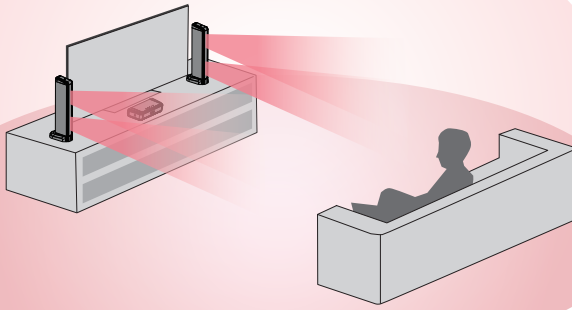

### Placement horizontal

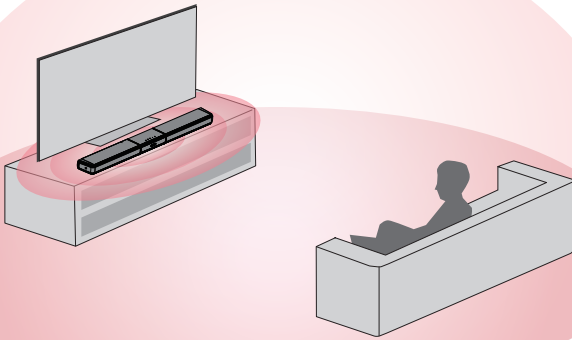

**Remarque:** Pour une meilleure écoute, disposez l'ensemble du système comme indiqué sur l'image ci-dessus.

## 9 INSTALLATION MURALE

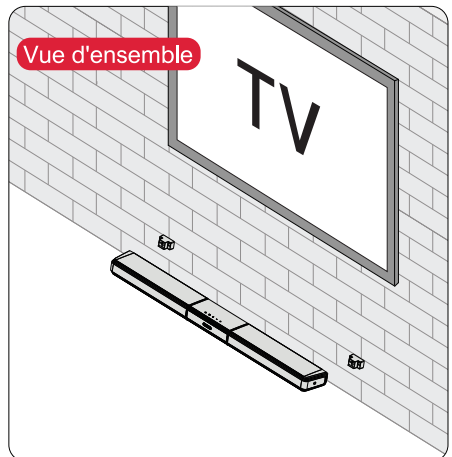
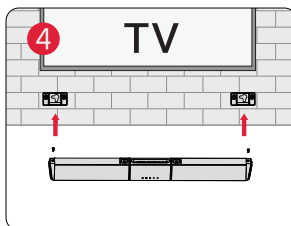
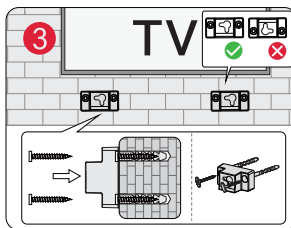
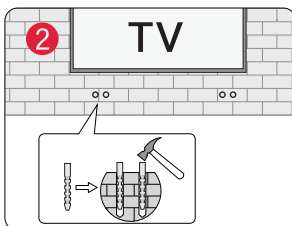
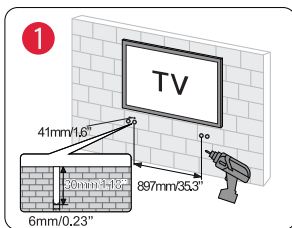

<b>Numéro de modèle</b>	U3700
<b>Alimentation Électrique</b>	AC 100 - 240V, ~50/60Hz
<b>Pilotes de la barre de son</b>	2.25" x 5 (barre de son)
<b>Réponse en fréquence</b>	55Hz - 18kHz
<b>Puissance en veille</b>	<0.5W
<b>Température de fonctionnement</b>	0°C - 45°C / 32°F - 113°F
<b>Version Bluetooth</b>	5.3

Dimensions et poids	
<b>Barre de son</b>	977 (W) × 110 (D) × 58 (H)    38.5" × 4.3" × 2.3"
<b>Emballage</b>	440 (W) × 195 (D) × 290 (H)    17.3" × 7.7" × 11.4"
<b>Poids net</b>	3.0kg / 6.61lb
<b>Poids brut</b>	4.2kg / 9.26lb



ULTIMEA

Apollo S70

# Manuale d'uso



Numero di modello: U3700

## SIAMO PRONTI AD AIUTARE



support@ultimea.com  
support.ultimea.com

### Scansionare il codice per scaricare l'app

È anche possibile cercare "ULTIMEA" su Google Play o Apple Store per scaricare l'app



@ultimea\_official

+1 888-598-8875 (US) Mon-Fri 9am-5pm (PST)  
+49 89-628-25828 (EU) Mon-Fri 9am-5pm (CET)

## 1 ELENCO ACCESSORI



Unità sinistra e unità destra



Unità centrale



Adattatore di alimentazione

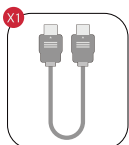

Cavo HDMI

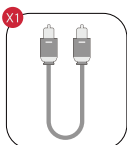

Cavo ottico digitale

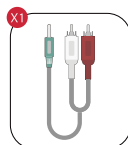

Cavo audio stereo da 3,5 mm a RCA

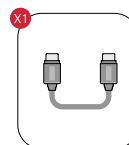

Cavo a 4 pin per collegamento alla soundbar (100 mm)

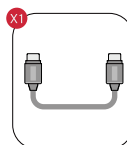

Cavo a 4 pin per collegamento alla soundbar (180 mm)

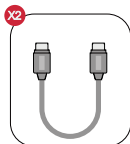

Cavo a 4 pin per collegamento alla soundbar (2 m)

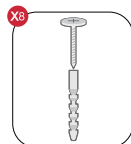

Kit per il montaggio a parete

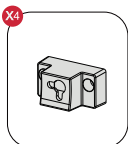

Staffa a muro



Telecomando

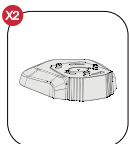

Base



Manuale d'uso

## 2 CONTROLLI DELLA SOUNDBAR

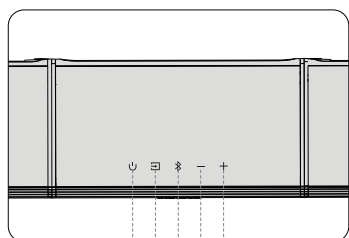





















1 2 3 4 5

### Pannello di controllo

- 1** "Power": **Pulsante di accensione**  
Premere il pulsante di accensione per accendere/spengere.
- 2** "Source": **Fonte**  
Premere per cambiare canale:  
ARC-OPT(OPTICAL)-BT-AUX-USB.
- 3** "Bluetooth": **Bluetooth**  
Premere per passare al canale BT e accedere alla modalità di accoppiamento.  
Tenere premuto per 3 secondi per scollegare il dispositivo corrente e scegliere di collegarsi manualmente a un nuovo dispositivo sul cellulare / PC / TV (ID BT: Apollo S70).
- 4** "Volume down": **Volume giù**
- 5** "Volume up": **Volume su**

## Telecomando

- 1 “”: **Pulsante di Accensione**  
Premere per accendere/spengere il dispositivo.
- 2 “”: **Fonte**  
Premere per cambiare canale: ARC-OPT-BT-AUX-USB.
- 3 “”: **ARC**  
Premere per passare al canale HDMI ARC.
- 4 “”: **OPT**  
Premere per passare al canale OTTICO.
- 5 “”: **AUX**  
Premere per passare al canale AUX.
- 6 “”: **BT**  
Premere per passare al canale BLUETOOTH.
- 7 “”: **USB**  
Premere per passare al canale USB.
- 8 “”: **INFO**  
Premere per visualizzare le informazioni sullo stato: Versione del software; EQ; Bassi/Medi/Alti.
- 9 “”: **RIPETIZIONE USB**  
Modalità USB: Premere per passare dalla riproduzione di un singolo loop a quella di un elenco.
- 10 “+”: **Volume Su**
- 11 “-”: **Volume Giù**
- 12 “<”: **Precedente**  
Solo per la modalità BT e USB: Passa alla traccia precedente.
- 13 “>”: **Successivo**  
Solo per la modalità BT e USB: Passa al brano successivo.
- 14 “”: **Riproduzione / Pausa**  
Solo per la modalità BT e USB.
- 15 “”: **MUTE**
- 16 “”: **DIMMER A LED**  
Premere per regolare la luminosità del display su 5 livelli. Tenere premuto per 3 secondi per spegnere il display.
- 17 “”: **BASSMAX**  
Premere per regolare il livello dei bassi; il display visualizza: “B5-6”, “B5-5”, “B5-4”, “B5-3”, “B5-2”, “B5-1”, “B5 0”, “B5 1”, “B5 2”, “B5 3”, “B5 4”, “B5 5”, “B5 6”.
- 18 “”: **MEDIO**  
Premere per regolare il livello dei contralti; il display visualizza: “MR-6”, “MR-5”, “MR-4”, “MR-3”, “MR-2”, “MR-1”, “MR 0”, “MR 1”, “MR 2”, “MR 3”, “MR 4”, “MR 5”, “MR 6”.
- 19 “”: **TREBLE**  
Premere per regolare il livello degli acuti; il display visualizza: “T3-6”, “T3-5”, “T3-4”, “T3-3”, “T3-2”, “T3-1”, “T3 0”, “T3 1”, “T3 2”, “T3 3”, “T3 4”, “T3 5”, “T3 6”.
- 20 “”: **MOVIE**  
Premere per passare alla modalità MOVIE; il display visualizza: “MOVI”.
- 21 “”: **MUSIC**  
Premere per passare al modo MUSIC, il display visualizza: “MUSC”.
- 22 “”: **VOCE**  
Premere per passare alla modalità VOICE, il display visualizza: “VOIC”.
- 23 “”: **SPORT**  
Premere per passare alla modalità SPORT, il display visualizza: “SPRT”.
- 24 “”: **GAME**  
Premere per passare alla modalità GAME, il display visualizza: “GAME”.
- 25 “”: **NOTTE**  
Premere per passare alla modalità NIGHT, il display visualizza: “NIGT”.
- 26 “**PROMPT TONE**”: **TONO DI RICHIESTA**  
Premere per regolare il livello del tono di richiesta; il display visualizza: “PT 0”, “PT 1”, “PT 2”, “PT 3”.
- 27 “**RGB LIGHTING**”: **ILLUMINAZIONE RGB**  
Premere “+” o “-” per regolare la luminosità degli effetti di illuminazione RGB. Premere brevemente il pulsante centrale per accendere e cambiare la modalità degli effetti di illuminazione, premere a lungo per 3 secondi per spegnere l'effetto di illuminazione.

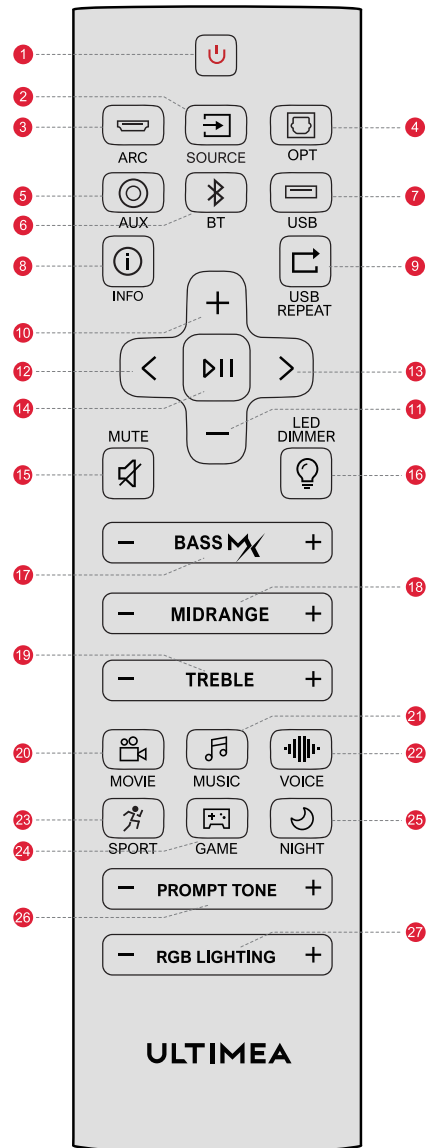

### 3 INSTALLAZIONE DELLA SOUNDBAR

Separato e posato sulla base :

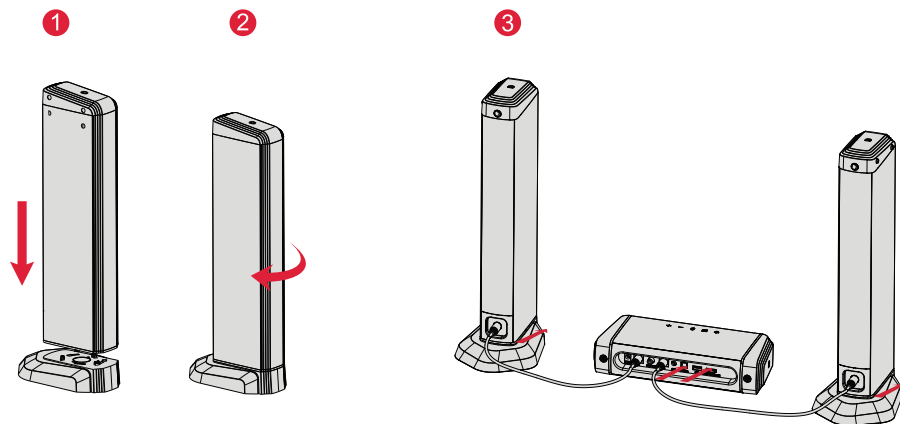

- 1 Posizionare la soundbar sulla base e allineare le giunture.
- 2 Girare per collegare alla base.
- 3 Collegare il cavo a 4 pin (Cavo 1 & Cavo 2) per la connessione della soundbar.

Nota: Quando si collega il cavo, il terminale rosso viene inserito nella porta rossa e il terminale bianco viene inserito nella porta bianca.

Posizionamento orizzontale :

- 1 Rimuovere le coperture su entrambi i lati del dispositivo principale.

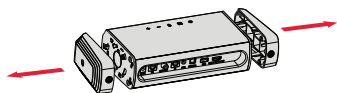

- 2 Allineare le giunture delle tre parti.

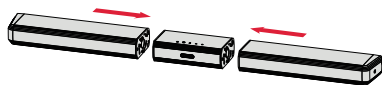

- 3 Girare per collegare.

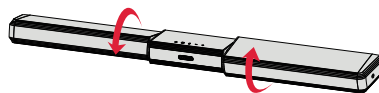

- 4 Collegare il cavo a 4 pin (Cavo 3 & Cavo 4) per la connessione della soundbar.

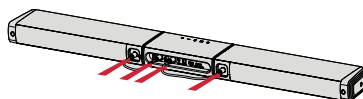

### 4 PANNELLO POSTERIORE

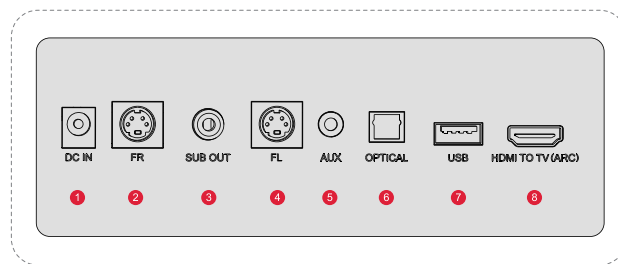

- 1 **DC IN**
- 2 **FR: FRONT RIGHT**  
Usato per collegare la macchina ausiliaria sulla destra
- 3 **SUB OUT**  
Collegare a un subwoofer attivo (non incluso)
- 4 **FL: FRONT LEFT**  
Usato per collegare la macchina ausiliaria sulla sinistra
- 5 **AUX**
- 6 **OTTICO**
- 7 **USB**  
Supporto file MP3 con memoria massima di 128 GB
- 8 **HDMI VERSO TV (ARC)**

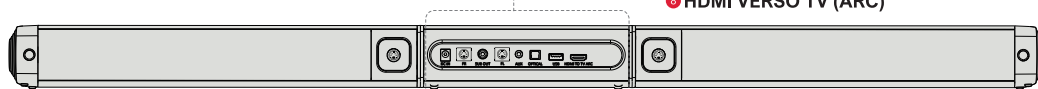

## 5 COLLEGAMENTO ALLA TV VIA ARCO

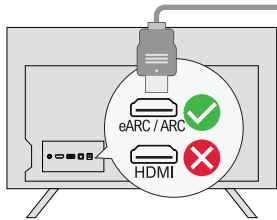

**Passo 1:**  
Collegare un'estremità del cavo HDMI alla porta eARC / ARC del televisore.

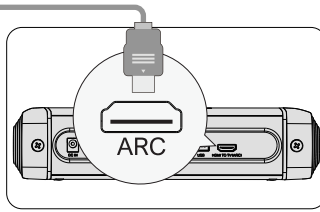

**Passo 2:**  
Collegare quindi l'altra estremità alla porta ARC della soundbar.

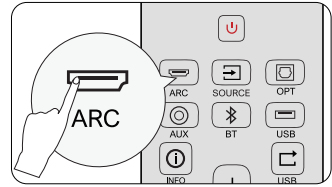

**Passo 3:**  
Premere il pulsante "ARC" sul telecomando per selezionare l'ingresso "ARC".

**Nota: attivare la funzione "CEC" sul televisore.**

Quando l'ARC è collegato, il telecomando del televisore può controllare contemporaneamente la soundbar e il televisore:

1 Accendere/spengere 2 Regolare il volume

**Se non c'è suono: provare a impostare l'uscita audio del televisore su PCM :** Impostazioni TV > Home > Impostazioni > Suono > Uscita audio digitale > PCM

## 6 COLLEGAMENTO ALLA TV VIA OTTICA / AUX

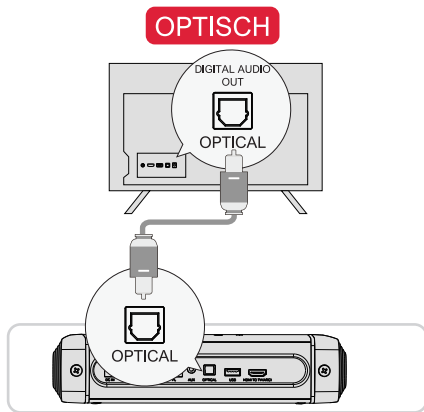

**OPZIONE 1: OTTICO**

1 Assicurarsi che la porta del televisore sia OPTICAL OUT, collegare entrambi i lati del cavo a OPTICAL, sia per il televisore che per la soundbar.

2 Assicurarsi che la spina ottica sia inserita correttamente come mostrato nell'immagine. Non inserire la spina al contrario e non rompere l'ottica.

**Nota:** se l'audio viene riprodotto dagli altoparlanti interni del televisore, disattivare o ridurre al minimo il volume del televisore.

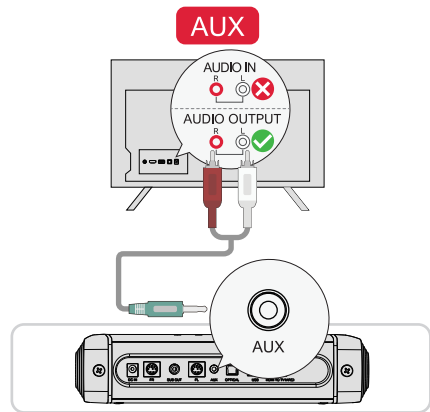

**OPZIONE 2: AUX**

1 Collegare il cavo audio da 3.5 mm a RCA alla porta RCA AUDIO OUT del televisore.

2 Assicurarsi che il colore delle estremità dei cavi corrisponda a quello delle porte del televisore.

**Nota:** ricordarsi di scollegare il cavo AUX dal televisore e dalla Soundbar quando si desidera passare a un'altra modalità.

**In modalità ottica: Se non si sente alcun suono, provare a impostare l'uscita audio del televisore su PCM**  
Impostazioni TV > Home > Impostazioni > Audio > Uscita audio digitale > PCM

## 7 CONNESSIONE AL BLUETOOTH®

1 Premere il pulsante "Bluetooth" sulla soundbar o sul telecomando per accedere alla modalità di accoppiamento Bluetooth.

2 Aprire le impostazioni Bluetooth del telefono, trovare e selezionare "Apollo S70" per collegare la soundbar.

**Nota:** se è già in modalità Bluetooth e connessa, tenere premuto il pulsante "Bluetooth" per 3 secondi per scollegare il dispositivo corrente e collegarlo manualmente al nuovo dispositivo sul telefono cellulare / PC / TV.

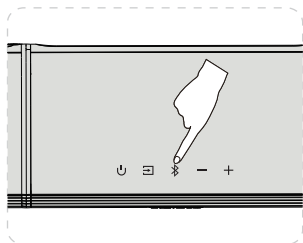

or

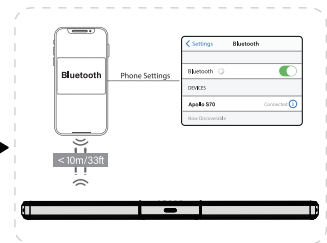
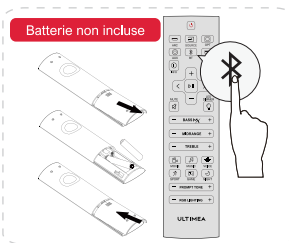

### Separato e posato sulla base

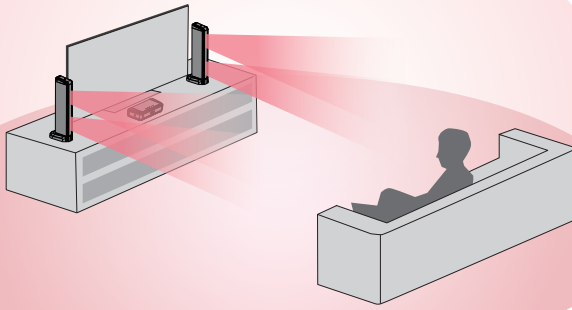

### Posizionamento orizzontale

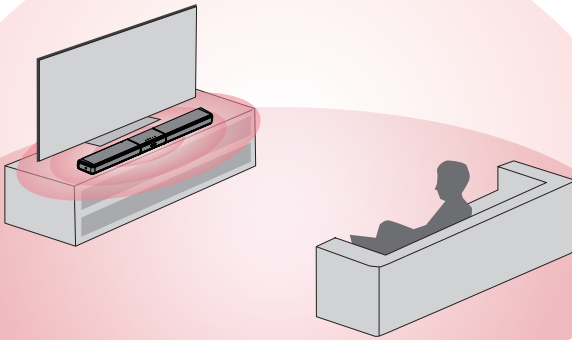

**Nota:** Per una migliore esperienza di ascolto, disponete l'intero sistema come mostrato nella figura precedente.

## 9 INSTALLAZIONE A PARETE

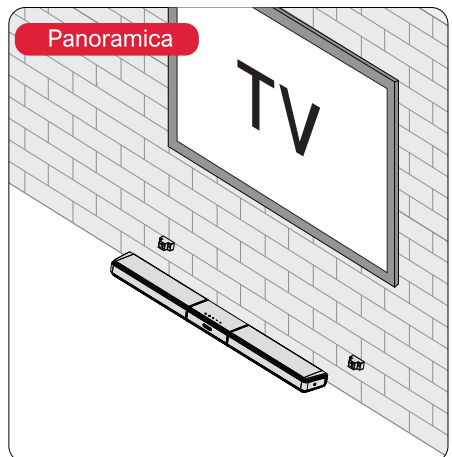
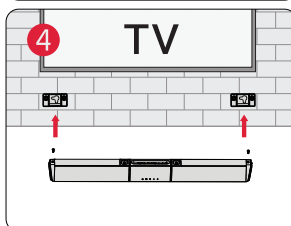
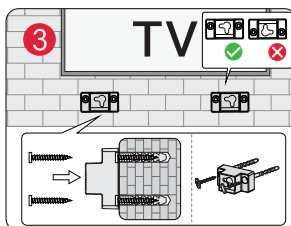
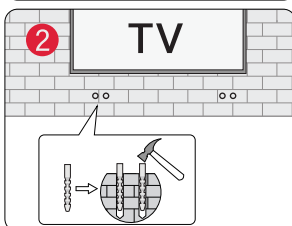
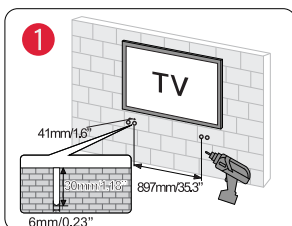

<b>Numero di modello</b>	U3700
<b>Alimentazione</b>	AC 100 - 240V, ~50/60Hz
<b>Driver della barra audio</b>	2.25" x 5 (barra audio)
<b>Risposta in frequenza</b>	55Hz - 18kHz
<b>Potenza in standby</b>	<0.5W
<b>Temperatura di esercizio</b>	0°C - 45°C / 32°F - 113°F
<b>Versione Bluetooth</b>	5.3

<b>Dimensioni e peso</b>	
<b>Soundbar</b>	977 (W) × 110 (D) × 58 (H)    38.5" × 4.3" × 2.3"
<b>Imballaggio</b>	440 (W) × 195 (D) × 290 (H)    17.3" × 7.7" × 11.4"
<b>Peso netto</b>	3.0kg / 6.61lb
<b>Peso lordo</b>	4.2kg / 9.26lb

ULTIMEA

Apollo S70

# Manual del usuario

## ESTAMOS LISTOS PARA AYUDAR



support@ultimea.com  
support.ultimea.com



Número de modelo: U3700

### Escanee el código para descargar la aplicación

También puedes buscar "ULTIMEA" en Google Play o Apple Store para descargar la aplicación



@ultimea\_oficial

+1 888-598-8875 (US) Mon-Fri 9am-5pm (PST)  
+49 89-628-25828 (EU) Mon-Fri 9am-5pm (CET)



ES

## 1 LISTA DE ACCESORIOS



Unidad izquierda y unidad derecha



Unidad central



Adaptador de corriente

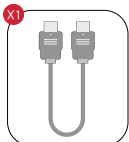

Cable HDMI

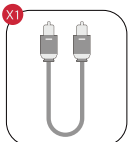

Cable digital óptico

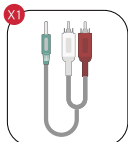

Estéreo de 3,5 mm a RCA Cable de audio

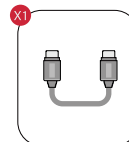

Cable de 4 pines para conexión a la barra de sonido (100 mm)

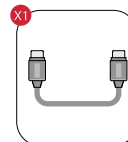

Cable de 4 pines para conexión a la barra de sonido (180 mm)

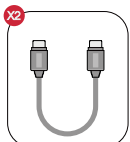

Cable de 4 pines para conexión a la barra de sonido (2m)

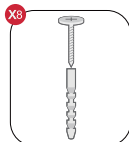

Kit de montaje en pared

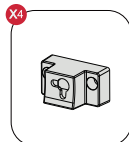

Soporte de pared



Mando a distancia

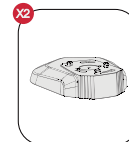

Base



Manual del usuario

## 2 CONTROLES DE LA BARRA DE SONIDO

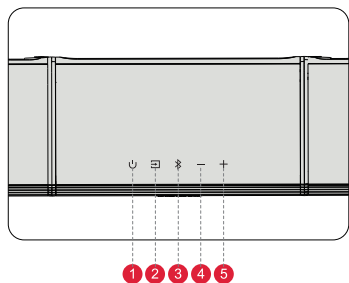

### Panel de control

- 1 "⏻": **Botón de encendido**  
Pulse el botón de encendido para encender/apagar.
- 2 "📺": **Fuente**  
Pulse para cambiar de canal:  
ARC-OPT(OPTICAL)-BT-AUX-USB.
- 3 "📶": **Bluetooth**  
Pulse para cambiar al canal BT y entrar en el modo de emparejamiento.  
Mantenga pulsado durante 3 segundos para desconectar el dispositivo actual y elija conectarse a un nuevo dispositivo manualmente en su teléfono móvil / PC / TV (BT ID: Apollo S70).
- 4 "⏮": **Bajar Volumen**
- 5 "⏭": **Subir Volumen**

## Mando a Distancia

- 1 "U": **Botón de encendido**  
Pulse para encender / apagar.
- 2 "☐": **Fuente**  
Pulse para cambiar de canal: ARC-OPT-BT-AUX-USB.
- 3 "≡": **ARC**  
Pulse aquí para cambiar al canal HDMI ARC.
- 4 "◻": **OPT**  
Pulse aquí para cambiar al canal OPTICAL.
- 5 "⊙": **AUX**  
Pulse para cambiar al canal AUX.
- 6 "🔗": **BT**  
Pulse para cambiar al canal BLUETOOTH.
- 7 "≡": **USB**  
Pulse para cambiar al canal USB.
- 8 "i": **INFORMACIÓN**  
Presione para ver información de estado: Versión del software; EQ; Graves/Medios/Agudos.
- 9 "↺": **REPETICIÓN USB**  
Modo USB: Pulse este botón para cambiar entre reproducción en bucle simple y reproducción en bucle de lista.
- 10 "+": **Subir volumen**
- 11 "-": **Bajar volumen**
- 12 "<": **Anterior**  
Sólo para los modos BT y USB: Salta a la pista anterior.
- 13 ">": **Siguiente**  
Sólo para los modos BT y USB: Salta a la pista siguiente.
- 14 "⏮": **Reproducir / Pausa**  
Sólo para los modos BT y USB.
- 15 "🔇": **MUTE**
- 16 "💡": **ATENUADOR LED**  
Pulse para ajustar el brillo de la pantalla en 5 niveles. Manténgalo pulsado durante 3 segundos para apagar la pantalla.
- 17 "BASS MAX": **BASSMAX**  
Pulse para ajustar el nivel de graves, la pantalla mostrará:  
"BS-6", "BS-5", "BS-4", "BS-3", "BS-2", "BS-1", "BS 0", "BS 1",  
"BS 2", "BS 3", "BS 4", "BS 5", "BS 6".
- 18 "MIDRANGE": **MEDIOS**  
Pulse para ajustar el nivel de agudos, la pantalla mostrará:  
"MR-6", "MR-5", "MR-4", "MR-3", "MR-2", "MR-1", "MR 0", "MR 1",  
"MR 2", "MR 3", "MR 4", "MR 5", "MR 6".
- 19 "TREBLE": **AGUDOS**  
Pulse este botón para ajustar el nivel de agudos; la pantalla mostrará:  
"TB-6", "TB-5", "TB-4", "TB-3", "TB-2", "TB-1", "TB 0",  
"TB 1", "TB 2", "TB 3", "TB 4", "TB 5", "TB 6".
- 20 "🎬": **MOVIE**  
Pulse para cambiar al modo MOVIE, la pantalla mostrará: "MOVI".
- 21 "🎵": **MÚSICA**  
Pulse para cambiar al modo MUSIC, la pantalla mostrará: "MUSC".
- 22 "🎤": **VOZ**  
Pulse para cambiar al modo VOICE, la pantalla mostrará: "VOIC".
- 23 "🏃": **SPORT**  
Pulse para cambiar al modo SPORT, la pantalla mostrará: "SPRT".
- 24 "🎮": **JUEGO**  
Pulse para cambiar al modo GAME, en la pantalla aparecerá: "GAME".
- 25 "🌙": **NOCHE**  
Pulse para cambiar al modo NIGHT, la pantalla mostrará: "NIGT".
- 26 "PROMPT TONE": **TONO DE AVISO**  
Pulse para ajustar el nivel del tono de aviso, la pantalla mostrará: "PT 0", "PT 1", "PT 2", "PT 3".
- 27 "RGB LIGHTING": **ILUMINACIÓN RGB**  
Presione "+" o "-" para ajustar el brillo de los efectos de iluminación RGB. Presione brevemente el botón central para encender y cambiar el modo de efecto de iluminación, mantenga presionado durante 3 segundos para apagar el efecto de iluminación.

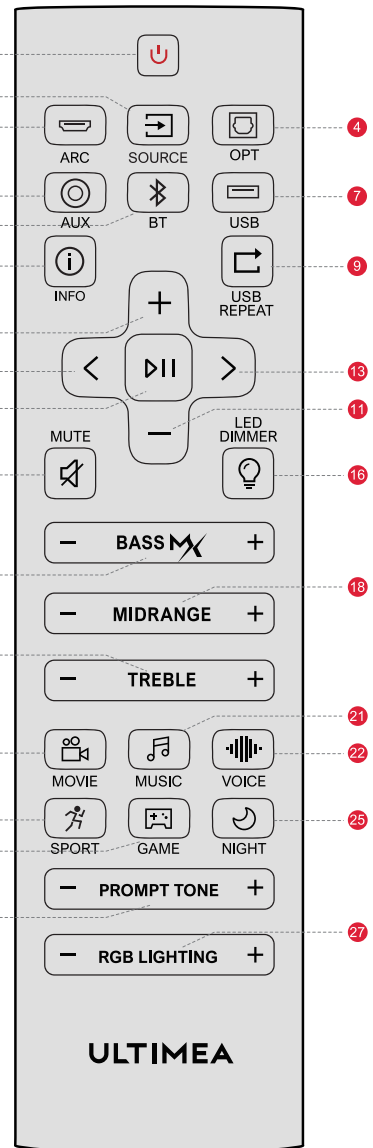



## 3 INSTALACIÓN DE LA BARRA DE SONIDO

### Separado y colocado en la base:

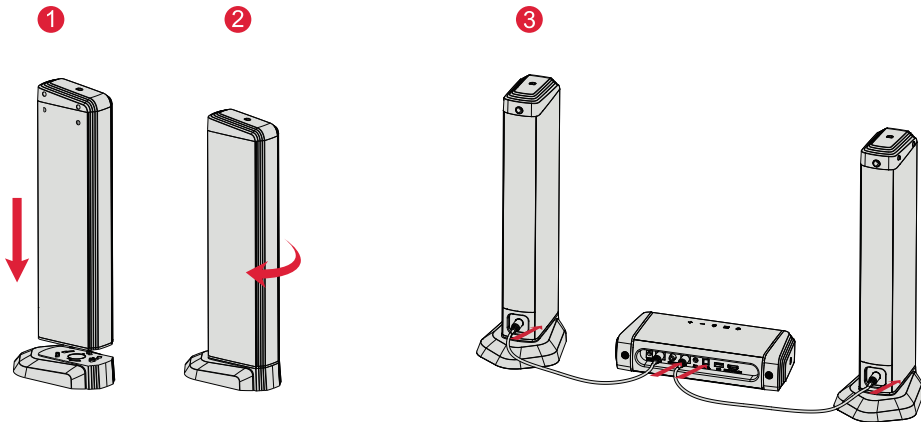

- 1 Coloque la barra de sonido en la base y alinee las juntas.
- 2 Gire para conectar con la base.
- 3 Conecte el cable de 4 pines (Cable 1 y Cable 2) para la conexión de la barra de sonido.

Nota: Al conectar el cable, el terminal rojo se enchufa en el puerto rojo y el terminal blanco se enchufa en el puerto blanco.

### Colocación horizontal :

- 1 Retire las cubiertas de ambos lados del dispositivo principal.

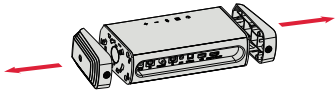

- 2 Alinee las juntas de las tres partes.

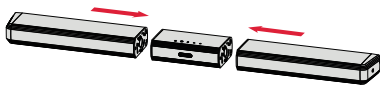

- 3 Gire para conectar.

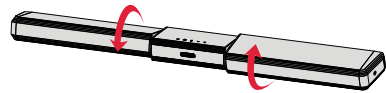

- 4 Conecte el cable de 4 pines (Cable 3 y Cable 4) para la conexión de la barra de sonido.

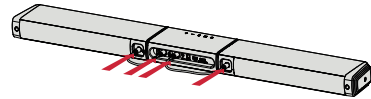

## 4 PANEL POSTERIOR

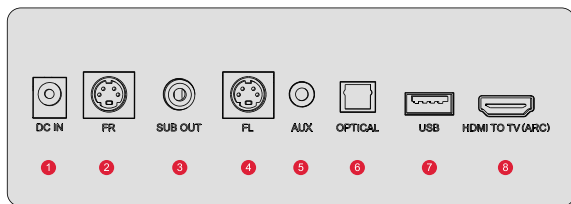

- 1 **DC IN**
- 2 **FR: FRONT RIGHT**  
Usado para conectar la máquina auxiliar en la derecha
- 3 **SUB OUT**  
Conectar a un subwoofer activo (no incluido)
- 4 **FL: FRONT LEFT**  
Usado para conectar la máquina auxiliar en la izquierda
- 5 **AUX**
- 6 **ÓPTICO**
- 7 **USB**  
Soporte de archivo MP3 con memoria máxima de 128 GB
- 8 **HDMI A TV (ARC)**



## 5 CONECTAR A TV MEDIANTE ARCO

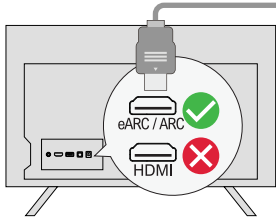

**Paso 1:**  
Conecte un extremo del cable HDMI al puerto eARC / ARC de su televisor.

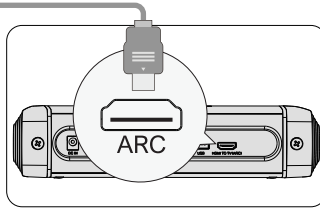

**Paso 2:**  
A continuación, conecte el otro extremo al puerto ARC de la barra de sonido.

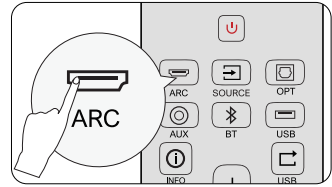

**Paso 3:**  
Pulse el botón "ARC" del mando a distancia para seleccionar la entrada "ARC".

**Nota: Active la función "CEC" en su televisor.**

Cuando ARC está conectado, el mando a distancia de su TV puede controlar la barra de sonido y la TV simultáneamente:

- 1 Encender/Apagar
- 2 Ajustar el volumen

**Si no hay sonido: intente ajustar la salida de audio del televisor a PCM:** Ajustes TV > Inicio > Ajustes > Sonido > Salida de audio digital > PCM.

## 6 CONECTAR AL TELEVISOR POR VÍA ÓPTICA / AUX

**OPTISCH**

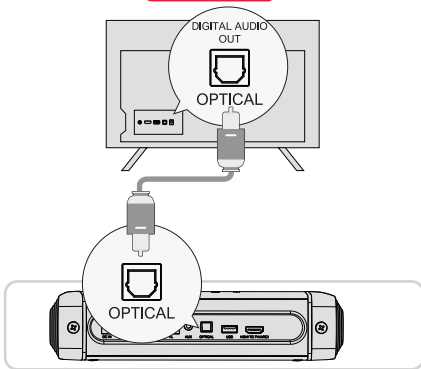

**OPCIÓN 1: ÓPTICO**

- 1 Asegúrese de que el puerto del televisor es OPTICAL OUT, conecte ambos lados del cable a OPTICAL, tanto para el televisor como para la barra de sonido.
- 2 Asegúrese de que el conector óptico está insertado correctamente como se muestra en la imagen. No inserte la clavija al revés y rompa el cable óptico.

**Nota:** Si se reproduce audio por los altavoces internos del televisor, silencio o minimice el volumen del televisor.

**AUX**

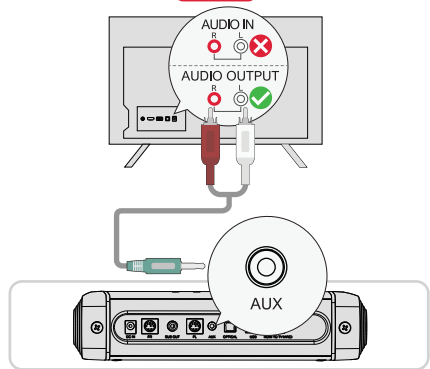

**OPCIÓN 2: AUX**

- 1 Conecta el cable de audio de 3.5 mm a RCA al puerto RCA AUDIO OUT de tu TV.
- 2 Asegúrese de que el color de los extremos de los cables coincide con el color de los puertos de TV.

**Nota:** Recuerde desconectar el cable AUX de la TV y del Soundbar cuando quiera cambiar a otro modo.

**En Modo Óptico: Si no hay sonido, pruebe a ajustar la salida de audio del TV a PCM:**  
Ajustes TV > Inicio > Ajustes > Sonido > Salida Audio Digital > PCM

## 7 CONECTAR A BLUETOOTH®

- 1 Pulse el botón "Bluetooth" en la barra de sonido o en el mando a distancia para entrar en el modo de emparejamiento Bluetooth.
- 2 Abra la configuración de Bluetooth de su teléfono, busque y seleccione "Apollo S70" para conectar la barra de sonido.

**Nota:** Si ya está en el modo Bluetooth y conectado, mantenga pulsado el botón "Bluetooth" durante 3 segundos para desconectar el dispositivo actual y conectarse al nuevo dispositivo manualmente en su teléfono móvil / PC / TV.

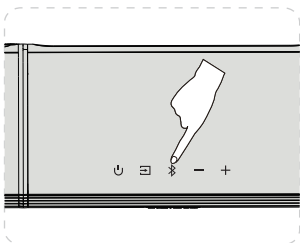

or

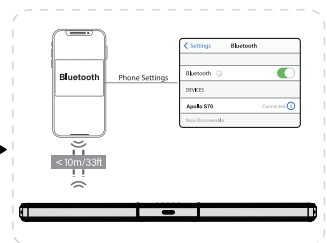

## 8 OPCIONES DE COLOCACIÓN

### Separado y colocado en la base

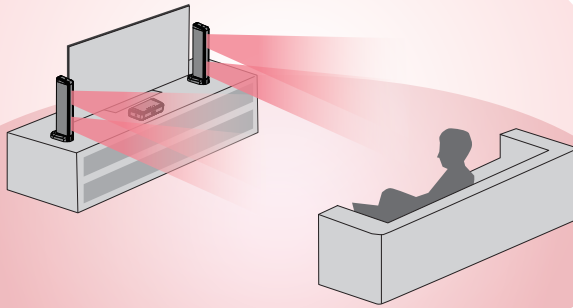

ES

### Colocación horizontal

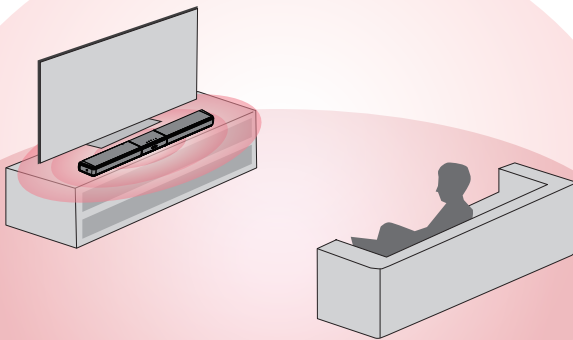

**Nota:** Para una mejor experiencia de escucha, disponga todo el sistema como se muestra en la imagen superior.

## 9 INSTALACIÓN MURAL

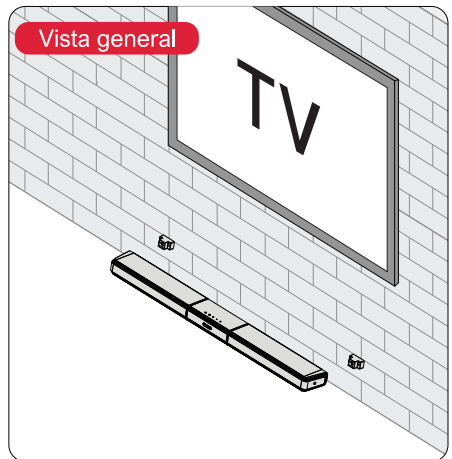
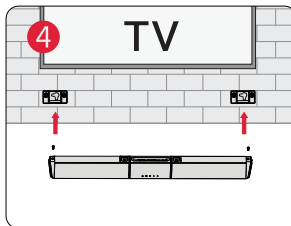
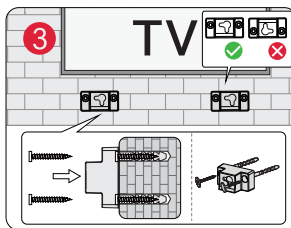
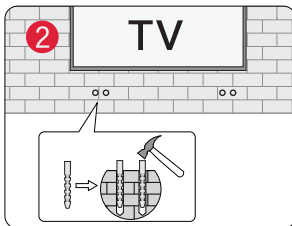
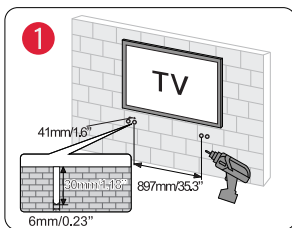

<b>Número de modelo</b>	U3700
<b>Fuente de alimentación</b>	AC 100 - 240V, ~50/60Hz
<b>Controladores de la barra de sonido</b>	2.25" x 5 (barra de sonido)
<b>Respuesta en frecuencia</b>	55Hz - 18kHz
<b>Potencia en espera</b>	<0.5W
<b>Temperatura de funcionamiento</b>	0°C - 45°C / 32°F - 113°F
<b>Versión Bluetooth</b>	5.3

<b>Dimensiones y peso</b>	
<b>Barra de sonido</b>	977 (W) × 110 (D) × 58 (H)    38.5" × 4.3" × 2.3"
<b>Embalaje</b>	440 (W) × 195 (D) × 290 (H)    17.3" × 7.7" × 11.4"
<b>Peso neto</b>	3.0kg / 6.61lb
<b>Peso bruto</b>	4.2kg / 9.26lb

## SAFETY INSTRUCTIONS

### Please read this user manual carefully and save it for future reference.

Do not make unauthorized alterations to the product, doing so may compromise safety, regulatory compliance, system performance, and may void the warranty.

- Avoid dropping.
- Do not disassemble.
- Do not submerge in water
- Avoid extreme temperatures.
- Do not use the device outdoors during thunderstorms.
- Use original or certified cables.
- Do not place dangerous items on top of this device (e.g. liquid filled objects, lit candles).
- Clean with a dry, soft lint-free cloth. Do not use any corrosive cleaner or oil.
- To avoid hearing damage, do not listen for extended periods at high volume.
- Do not expose the batteries to extreme heat sources such as direct sunlight or open flames.
- The ideal operating temperature for this product and its accessories is between 41°F/5°C and 95°F/35°C.
- The adapter should be installed near the device and should be easily accessible.
- Do not use this product in environments of extreme heat or cold. Never expose this device to strong sunshine or wet environments.

## PROPER DISPOSAL INSTRUCTIONS



This mark shown on the product or its packaging, indicates that this product should not be disposed of with other household waste at the end of its working life.

To prevent possible harm to the environment or human health from uncontrolled waste disposal, please separate this from other types of wastes and recycle it responsibly to promote the sustainable reuse of material resources.

### Waste Electrical & Electronic Equipment

Household user should contact either the retailer where they purchased this product, or their local government office, for details of where and how they can take this item for environmentally safe recycling.

Business users should contact their suppliers and check the terms and conditions of the purchase contract. This product should not be mixed with other commercial wastes for disposal.

## FCC REGULATORY COMPLIANCE

Any changes or modifications not expressly approved by the party responsible for compliance could void the user's authority to operate the equipment.

This device complies with Part 15 of the FCC Rules.

Operation is subject to the following two conditions:

- (1) This device may not cause harmful interference.
- (2) This device must accept any interference received, including interference that may cause undesired operation.

NOTE: This equipment has been tested and found to comply with the limits for a Class B digital device, pursuant to part 15 of the FCC Rules. These limits are designed to provide reasonable protection against harmful interference in a residential installation. This equipment generates, uses, and can radiate radio frequency energy, and if not installed and used in accordance with the instructions, may cause harmful interference to radio communications.

However, there is no guarantee that interference will not occur in a particular installation. If this equipment does cause harmful interference to radio or television reception, which can be determined by turning the equipment off and on, the user is encouraged to try to correct the interference by one or more of the following measures:

- Reorient or relocate the receiving antenna.
- Increase the separation between the equipment and the receiver.
- Connect the equipment to an outlet on a circuit different from that to which the receiver is connected.
- Consult the dealer or an experienced radio / TV technician for help.

This equipment complies with FCC radiation exposure limits set forth for an uncontrolled environment. This equipment should be installed and operated with a minimum distance of 20cm between the radiator & your body. This transmitter must not be co-located or operating in conjunction with any other antenna or transmitter.

## CE WARNINGS

- 1) Do not install this equipment in a confined or building-in space such as a book case or similar unit, and remain a well ventilation conditions. The ventilation should not be impeded by covering the ventilation openings with items such as newspaper, table-cloths, curtains etc.
- 2) WARNING: To reduce the risk of fire or electric shock, do not expose this apparatus to rain or moisture. The apparatus shall not be exposed to dripping or splashing and that objects filled with liquids, such as vases, shall not be placed on apparatus.
- 3) WARNING: The adapter plug is used as disconnect device, the disconnect device shall remain readily operable.
- 5) Frequency: 2.402GHz-2.48GHz
- 6) The Max. transmit power: 10 dBm

## ISED WARNINGS

This device contains licence-exempt transmitter (s) / receiver (s) that comply with Innovation, Science and Economic Development Canada's licence-exempt RSS (s). Operation is subject to the following two conditions:

- (1) This device may not cause interference.
- (2) This device must accept any interference, including interference that may cause undesired operation of the device.

L'émetteur/récepteur exempt de licence contenu dans le présent appareil est conforme aux CNR d'Innovation, Sciences et Développement économique Canada applicables aux appareils radio exempts de licence. L'exploitation est autorisée aux deux conditions suivantes:

- (1) L'appareil ne doit pas produire de brouillage;
- (2) L'appareil doit accepter tout brouillage radioélectrique subi, même si le brouillage est susceptible d'en compromettre le fonctionnement.

The device meets the exemption from the routine evaluation limits in section 2.5 of RSS 102 and compliance with RSS-102 RF exposure, users can obtain Canadian information on RF exposure and compliance.

Le dispositif rencontre l'exemption des limites courantes d'évaluation dans la section 2.5 de RSS 102 et la conformité à l'exposition de RSS-102 rf, utilisateurs peut obtenir l'information canadienne sur l'exposition et la conformité de rf.

This transmitter must not be co-located or operating in conjunction with any other antenna or transmitter. This equipment should be installed and operated with a minimum distance of 20 centimeters between the radiator and your body.

Cet émetteur ne doit pas être Co-placé ou ne fonctionnant en même temps qu'aucune autre antenne ou émetteur. Cet équipement devrait être installé et actionné avec une distance minimum de 20 centimètres entre le radiateur et votre corps.



## Declaration of Conformity

We (Manufacturer is responsible for this declaration)  
Ultimea Technology (Shenzhen) Limited  
(Company name)

20th Floor, Building 4, Tianan Cloud Park, Bantian St.,  
Longgang District Shenzhen, China 518000  
(Company address)

Declare under our sole responsibility that the product  
Trade Mark: ULTIMEA  
Product Name: Apollo S70 5.0 Channel Detachable  
Lighting Soundbar  
Model No.: U3700

To which this declaration relates is in conformity with  
the essential requirement set out in the Council Directive  
on the Approximation of the laws of the Member States  
relating to RED Directive (2014/53/EU) & RoHS (2011/  
65/EU) product is responsible to affix CE marking, the  
following standards were applied:

EN 55032:2015/A1:2020  
EN 55035:2017/A11:2020  
EN IEC 61000-3-2:2019/A1:2021  
EN 61000-3-3:2013/A2:2021  
ETSI EN 301 489-1 V2.2.3 (2019-11)  
ETSI EN 301 489-17 V3.2.4 (2020-09)  
ETSI EN 300 328 V2.2.2 (2019-07)  
EN 50663: 2017  
EN IEC 62368-1:2020+A11:2020  
IEC 62321-3-1:2013  
IEC 62321-4:2013+A1:2017  
IEC 62321-5:2013  
IEC 62321-6:2015  
IEC 62321-7-1:2015  
IEC 62321-7-2:2017  
IEC 62321-8:2017

Full Name: Yoyo.Yu

Position: Approbation Manager

Signature: 

Place/Date: Shenzhen, China / June. 30-2024

## Trade Marks:



The Bluetooth® word mark and logos are registered trademarks owned by Bluetooth SIG, Inc. and any use of such marks by Soundlab Technology Co.,Ltd. is under license. Other trademarks and trade names are those of their respective owners.



The terms HDMI, HDMI High-Definition Multimedia Interface, HDMI trade dress and the HDMI Logos are trademarks or registered trademarks of HDMI Licensing Administrator, Inc.

# ULTIMEA

Apollo S70 5.0 Channel Detachable Lighting Soundbar  
Model No.: U3700

EC	REP	Ultimea GmbH Buchenring 57, 22359 Hamburg, Germany
----	-----	---

UK	REP	EVATOST CONSULTING LTD Office 101 32 Threadneedle Street, London, United Kingdom, EC2R 8AY
----	-----	--

@Dyanic Inc. All rights reserved, registered in the United States and other countries.  
9804 Crescent Center Drive, Suite 604, Rancho Cucamonga, CA 91730

Made in China



Manufacturer: Ultimea Technology (Shenzhen) Limited  
Address: 20th Floor, Building 4, Tianan Cloud Park,  
Bantian St., Longgang District, Shenzhen, China 518000

If you need our support, kindly reach out to our service team. We are always glad to help.

+1 888-598-8875 (US)  
Mon-Fri 9am-5pm (PST)  
+49 89-628-25828 (EU)  
Mon-Fri 9am-5pm (CET)

✉ support@ultimea.com

🌐 support.ultimea.com



@ultimea\_official