

# ULTIMEA

**HDMI**<sup>™</sup>  
HIGH-DEFINITION MULTIMEDIA INTERFACE

**Bluetooth**<sup>®</sup>



## *User Manual*

**Apollo S40**

**EN:** User Manual

**FR:** Manuel de l'Utilisateur

**DE:** Benutzerhandbuch

**IT:** Manuale d'uso

**JP:** ユーザーマニュアル

**ES:** Manual del usuario

Model No.: U3300  
Apollo S40 2.2 Channel Detachable Soundbar



# Contents

01	User Manual	English
	Connection and Installation .....	02
06	Benutzerhandbuch	Deutsch
	Anschluss und Installation .....	07
11	ユーザーマニュアル	日本語
	接続と設置 .....	12
16	Mode d'Emploi	Français
	Raccordement et installation .....	17
21	Manuale d'uso	Italiano
	Connessione e installazione .....	22
26	Manual del usuario	Español
	Conexión e instalación .....	27



# User Manual

WE ARE  
READY  
TO HELP



support@ultimea.com



Model No.: U3300

**Prefer video tutorial?**

Setup guidance video, USER MANUAL or Trouble Shooting on ULTIMEA website.

@ultimea\_official



support.ultimea.com

+1 888-598-8875 (US) Mon-Fri 9am-5pm (PST)  
 +49 89-628-25828 (EU) Mon-Fri 9am-5pm (CET)

## 1 ACCESSORIES LIST

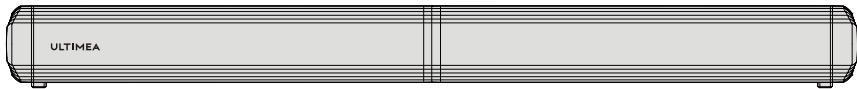

Soundbar



Power Adaptor

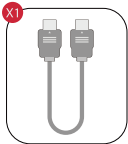

HDMI ARC

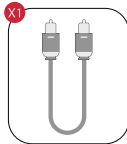

Digital Optical Cable

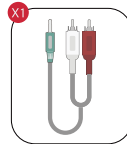

Stereo 3.5mm to RCA Audio Cable

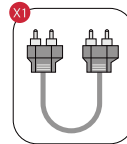

Stereo RCA to RCA Audio Cable(100mm)

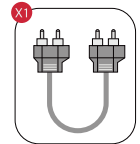

Stereo RCA to RCA Audio Cable(2.5m)

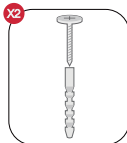

Wall Mounting Kit

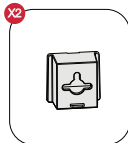

Wall Bracket



Remote Control

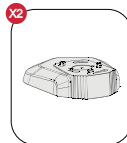

Base



User Manual



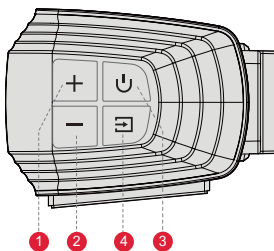





## 2 SOUNDBAR CONTROLS



**Control Panel**

- 1 **VOL+**: Volume Up.
- 2 **VOL-**: Volume Down.
- 3 **Power Button**: Press to power on / Hold for 3 seconds to power off.
- 4 **SOURCE**: Press to switch channels: ARC-OPT(OPTICAL)-BT-AUX-USB. Hold for 3 seconds to disconnect the current device and connect to a new device manually on your mobile phone / PC / TV (BT ID: Apollo S40)

## Remote Control

- 1 “”: **Power Button**  
Press to power on / Hold for 3 seconds to power off.
- 2 “”: **ARC**  
Press to switch to HDMI ARC channel.
- 3 “”: **BT**  
Press to switch to Bluetooth channel and enter pairing mode.  
Hold for 3 seconds to disconnect current device and connect to a new device manually on your mobile phone / PC / TV (BT ID: Apollo S40).
- 4 “”: **OPT**  
Press to switch to OPTICAL channel.
- 5 “”: **AUX**  
Press to switch to AUX channel.
- 6 “”: **LED**  
Press to turn off LED, press again to turn on.
- 7 “”: **USB**  
Press to switch to USB channel.
- 8 “+”: **Volume Up**
- 9 “-”: **Volume Down**
- 10 “<”: **Previous**  
For BT and USB mode only: Skip to previous track.
- 11 “>”: **Next**  
For BT and USB mode only: Skip to next track.
- 12 “”: **Play / Pause**  
For BT and USB mode only.  
USB mode: Hold for 3 seconds to switch between single loop playback and list loop playback
- 13 “**MOVIE**”: **MOVIE**  
Press to switch to MOVIE mode, the display will show: “E9 1”.
- 14 “**GAME**”: **GAME**  
Press to switch to GAME mode, the display will show: “E9 2”.
- 15 “**MUSIC**”: **MUSIC**  
Press to switch to MUSIC mode, the display will show: “E9 3”.
- 16 “**BASS MAX**”: **BASSMAX**  
Press to adjust bass level, the display will show: “b5- 1”, “b5 2”, “b5 1”.
- 17 “”: **Mute / Recover the volume.**

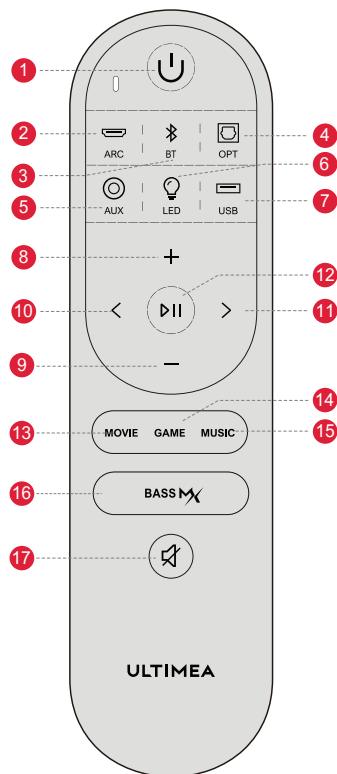

## 3 SOUNDBAR INSTALLATION

### Assembly steps:

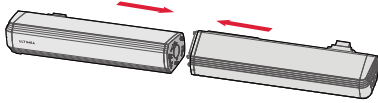
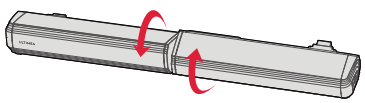
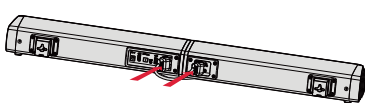
- 1 Align the joints of the two parts.  

- 2 Twist to connect.  

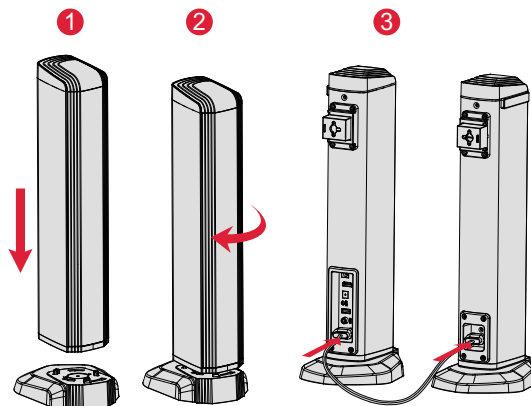
- 3 Plug in the Stereo RCA to RCA Audio Cable.  

### Detached and stand on base:



- 1 Set the soundbar on the base and align the joints.
- 2 Twist to connect with the base.
- 3 Plug in the Stereo RCA to RCA Audio Cable.

## 4 REAR PANEL

EN

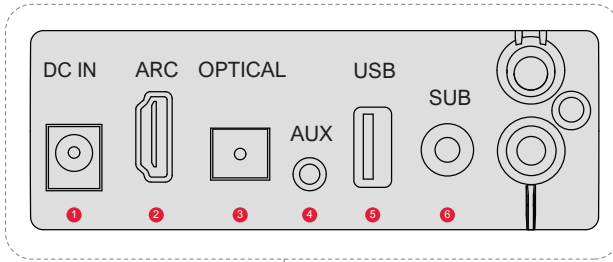

- 1 DC IN
- 2 HDMI ARC OUT
- 3 OPTICAL IN
- 4 AUX IN
- 5 USB Port:  
Support MP3 files with 64GB max memory.
- 6 SUB OUT:  
Connect to active subwoofer (Not Included)

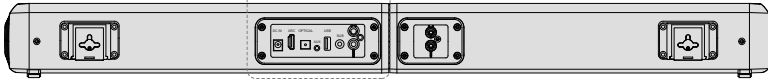

## 5 CONNECT TO TV VIA HDMI OUT ARC

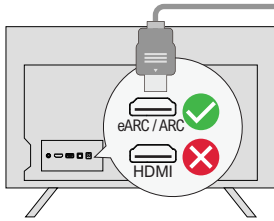

**Step 1:**  
Connect one end of the HDMI cable to the eARC / ARC port on the back of your TV.

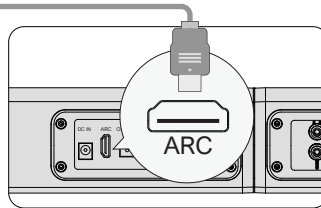

**Step 2:**  
Then connect the other end into the ARC port of the soundbar.

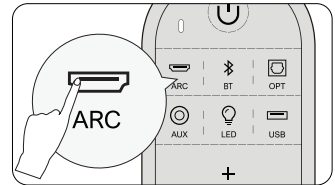

**Step 3:**  
Press "ARC" button on the remote control to select "ARC" input.

**If there is no sound, try setting the TV audio output to PCM:**

TV Settings > Home > Settings > Sound > Digital Audio Output > PCM

**Note: Please turn on the "CEC" function on your TV.**

When eARC / ARC is connected, your TV remote control can control the soundbar and TV simultaneously:

- 1 Turn on / off
- 2 Adjust the volume

## 6 CONNECT TO TV VIA OPTICAL / AUX

### OPTICAL

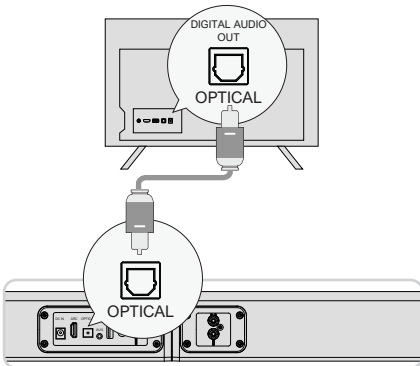

#### OPTION 1: OPTICAL

- 1 Make sure the TV's port is OPTICAL OUT, connect both sides of the cable to OPTICAL, for both the TV and the soundbar.
- 2 Make sure the optical plug is inserted correctly as it shows in the picture. Do not insert the plug upside down and break the optical.

**Note:** If audio is coming from the internal TV speakers, mute or minimize the TV volume.

### AUX

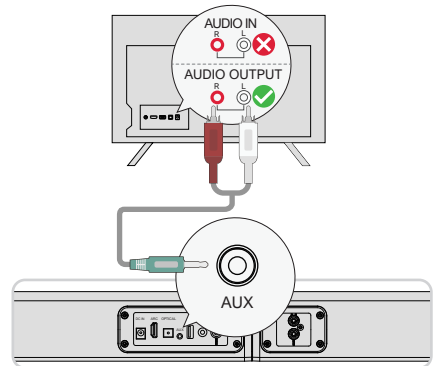

#### OPTION 2: AUX

- 1 Connect the 3.5mm to RCA audio cable to connect to your TV's RCA AUDIO OUT port.
- 2 Make sure the color of the cables ends matches the color of the TV ports.

**Note:** Please remember to unplug the AUX cable from TV and Soundbar when you want to switch other mode.

**In Optical Mode:** If there is no sound, try setting the TV audio output to PCM: TV Settings > Home > Settings > Sound > Digital Audio Output > PCM

## 7 CONNECT TO BLUETOOTH®

EN

- 1 Press the “” button on the soundbar or press the “” button on the remote control to enter Bluetooth pairing mode.
- 2 Go to the Bluetooth setting on your phone, find and select “**Apollo S40**” to connect the soundbar.

**Note:** If it's already in the Bluetooth mode and connected, press and hold “” button for 3 seconds to disconnect current device and choose to connect to a new device manually on your mobile phone / PC / TV.

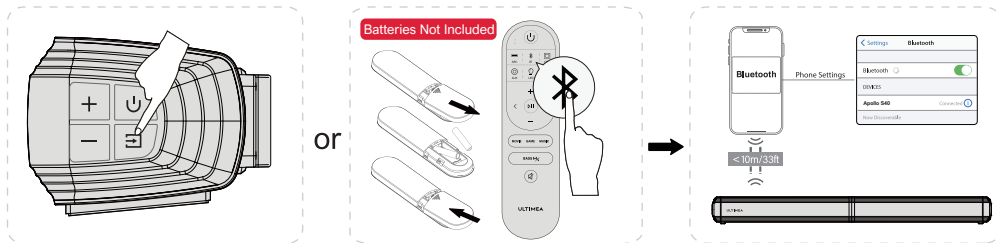

## 8 PLACEMENT OPTIONS

### Detached and stand on base

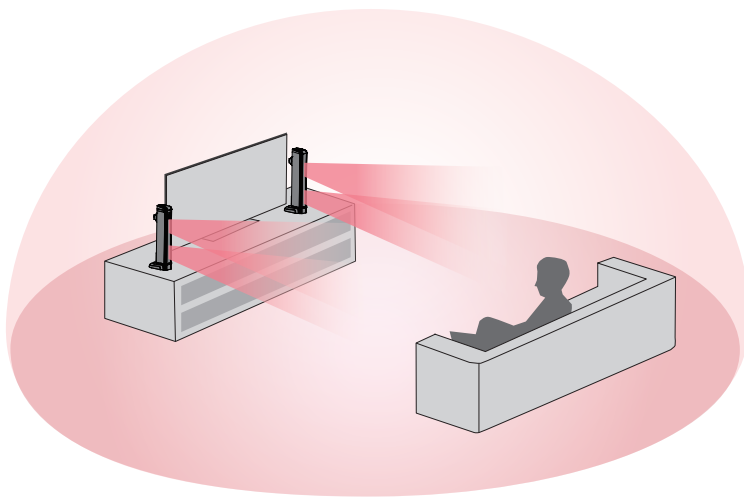

### Horizontal placement

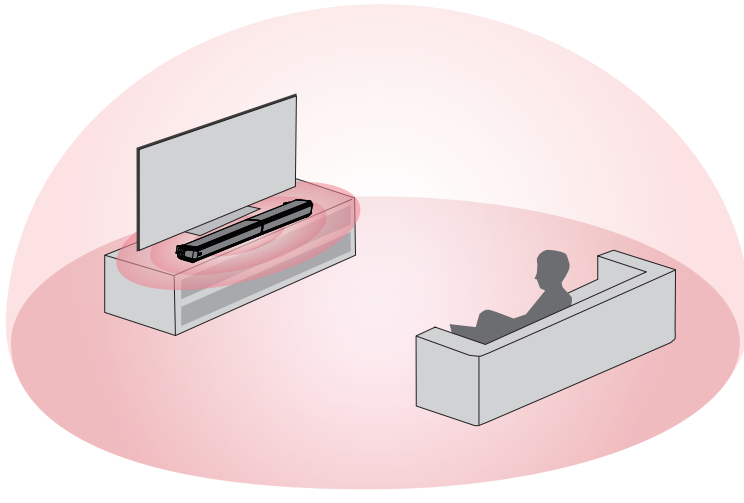

**Note:** The soundbar should be placed at or near ear level.



## 9 WALL MOUNT INSTALLATION

EN

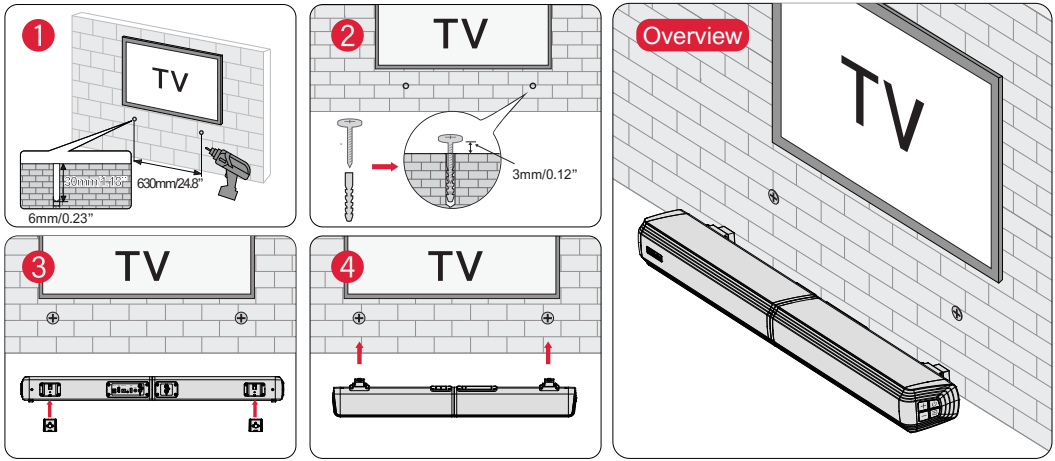

## 10 SPECIFICATIONS

<b>Model Number</b>	U3300
<b>Power Supply</b>	AC 100 - 240V, ~50 / 60Hz
<b>Soundbar Drivers</b>	2.25" x 4(Soundbar)
<b>Frequency Response</b>	45Hz - 18kHz
<b>Standby Power</b>	<0.5W
<b>Operating Temperature</b>	0°C - 45°C / 32°F - 113°F
<b>Bluetooth Vision</b>	5.3

Dimensions and Weight	
<b>Soundbar</b>	811(W) × 98(D) × 70(H)
<b>Packaging</b>	440(W) × 270(D) × 156(H)
<b>Net Weight</b>	2.3kg / 5.07lbs
<b>Gross Weight</b>	3.6kg / 7.94lbs

# Benutzerhandbuch

## WIR SIND BEREIT ZU HELFEN



support@ultimea.com



Modell Nr.: U3300

### Bevorzugen Sie ein Video-Tutorial?

Setup-Anleitung Video, oder  
USER MANUAL auf ULTIMEA  
Website.  
@ultimea\_official

support.ultimea.com

+1 888-598-8875 (US) Mon-Fri 9am-5pm (PST)  
+49 89-628-25828 (EU) Mon-Fri 9am-5pm (CET)

## 1 ZUBEHÖRLISTE

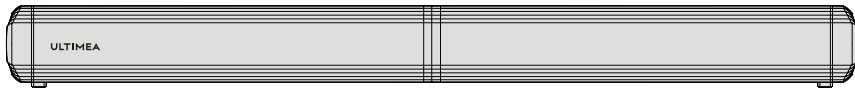

### Soundbar



Netzadapter

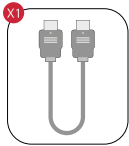

HDMI-Kabel

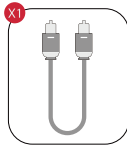

Optisches Digitalkabel

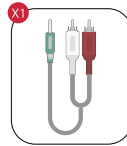
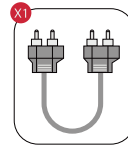
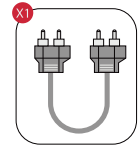
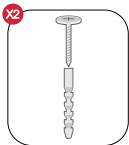
Stereo 3.5mm auf  
RCA AudiokabelStereo RCA auf RCA  
Audiokabel (100mm)Stereo-Cinch-auf-Cinch-  
Audiokabel (2,5 m)

Wandmontiertes Kit

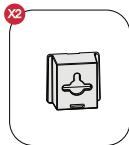

Wandhalterung



Fernsteuerung

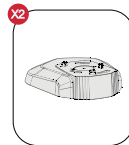

Basis



Benutzerhandbuch

## 2 BEDIENELEMENTE FÜR DIE SOUNDBAR

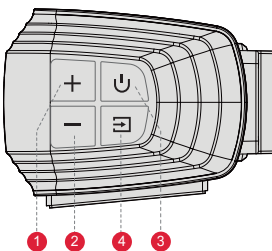

### Bedienfeld

- 1 **VOL+:** Lauter
- 2 **VOL-:** Lautstärke leiser
- 3 **Einschalttaste:**  
Zum Einschalten drücken / zum Ausschalten 3 Sekunden lang gedrückt halten.
- 4 **QUELLE:**  
Drücken, um den Kanal zu wechseln: ARC-OPT(OP-TISCH)-BT-AUX-USB.  
Halten Sie die Taste 3 Sekunden lang gedrückt, um die Verbindung zum aktuellen Gerät zu trennen und manuell eine Verbindung zu einem neuen Gerät auf Ihrem Mobiltelefon/P-C/Fernseher herzustellen (BT-ID: Apollo S40).

## Fernsteuerung

- 1 "U": **Einschalttaste**  
Zum Einschalten drücken / zum Ausschalten 3 Sekunden lang gedrückt halten.
- 2 "ARC": **ARC**  
Drücken Sie diese Taste, um zum HDMI ARC-Kanal zu wechseln.
- 3 "BT": **BT**  
Drücken Sie diese Taste, um zum Bluetooth-Kanal zu wechseln und den Kopplungsmodus zu aktivieren.  
Halten Sie die Taste 3 Sekunden lang gedrückt, um die Verbindung zum aktuellen Gerät zu trennen und manuell eine Verbindung zu einem neuen Gerät auf Ihrem Mobiltelefon/PC/Fernseher herzustellen (BT-ID: Apollo S40).
- 4 "OPT": **OPT**  
Drücken, um zum OPTICAL-Kanal zu wechseln.
- 5 "AUX": **AUX**  
Drücken Sie diese Taste, um zum AUX-Kanal zu wechseln.
- 6 "LED": **LED**  
Drücken, um die LED auszuschalten, erneut drücken, um sie einzuschalten.
- 7 "USB": **USB**  
Drücken, um zum USB-Kanal zu wechseln.
- 8 "+": **Lauter**
- 9 "-": **Lautstärke runter**
- 10 "<": **Zurück**  
Nur im BT- und USB-Modus: Zum vorherigen Titel springen.
- 11 ">": **Weiter**  
Nur für den BT- und USB-Modus: Zum nächsten Titel springen.
- 12 "▶||": **Wiedergabe / Pause**  
Nur für den BT- und USB-Modus.  
USB-Modus: 3 Sekunden lang gedrückt halten, um zwischen Einzel- und Listenschleifenwiedergabe umzuschalten.
- 13 "MOVIE": **MOVIE**  
Drücken Sie diese Taste, um in den MOVIE-Modus zu wechseln; auf dem Display erscheint: "E9 1".
- 14 "GAME": **GAME**  
Drücken Sie diese Taste, um in den GAME-Modus zu wechseln, auf dem Display erscheint: "E9 2".
- 15 "MUSIC": **MUSIC**  
Drücken Sie diese Taste, um in den MUSIC-Modus zu wechseln, auf dem Display erscheint: "E9 3".
- 16 "BASS MAX": **BASSMAX**  
Drücken Sie diese Taste, um den Basspegel einzustellen; auf dem Display wird angezeigt: "b5 1", "b5 0", "b5 1".
- 17 "🔊": **Stummschaltung / Wiederherstellung der Lautstärke.**

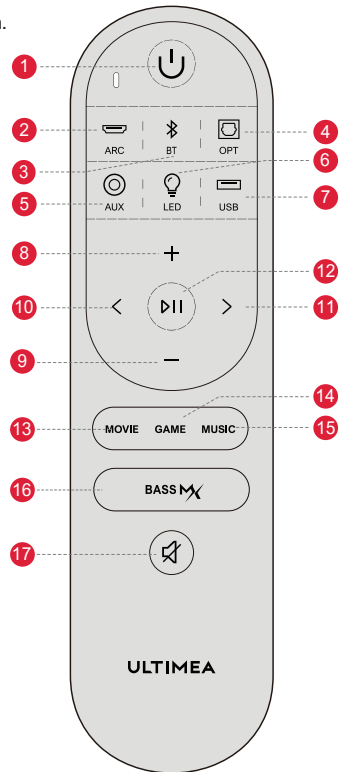

## 3 SOUNDBAR-INSTALLATION

### Montageschritte:

- 1 Richten Sie die Verbindungen der beiden Teile aus.

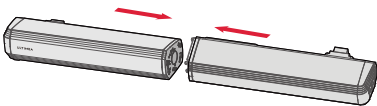

- 2 Zum Verbinden verdrehen.

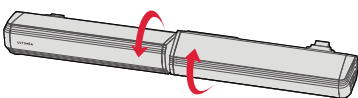

- 3 Schließen Sie das Stereo-Cinch-auf-Cinch-Audiokabel an.

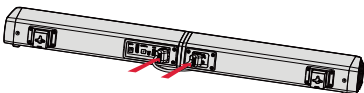

### Abnehmen und auf den Sockel stellen:

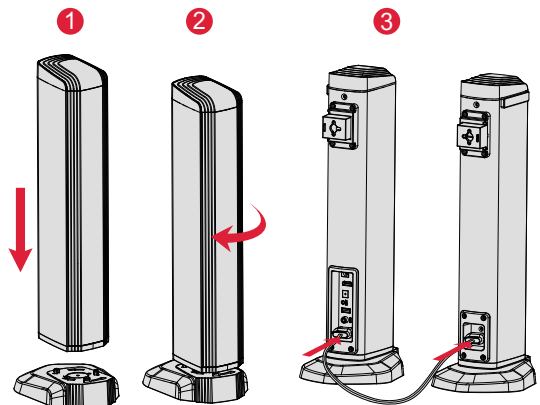

- 1 Setzen Sie die Soundbar auf den Sockel und richten Sie die Gelenke aus.
- 2 Drehen Sie sie, um sie mit dem Sockel zu verbinden.
- 3 Stecken Sie das Stereo-Cinch-auf-Cinch-Audiokabel ein.

## 4 RÜCKSEITE

DE

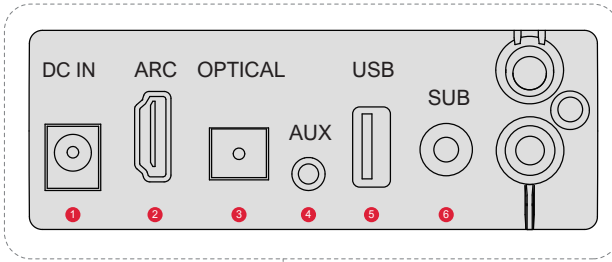

### 1 GLEICHSTROMEINGANG

### 2 HDMI ARC OUT

### 3 OPTICAL IN

### 4 AUX-EINGANG

### 5 USB-Anschluss:

Unterstützt MP3-Dateien mit maximal 64 GB Speicherplatz.

### 6 SUB OUT:

Zum Anschluss eines aktiven Subwoofers (nicht im Lieferumfang enthalten)

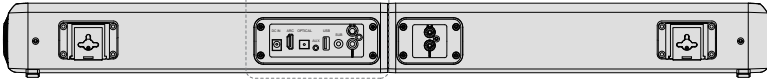

## 5 ANSCHLUSS AN FERNSEHER ÜBER ARC

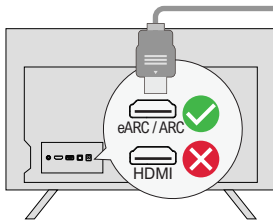

### Schritt 1:

Verbinden Sie ein Ende des HDMI-Kabels mit dem eARC / ARC-Anschluss auf der Rückseite Ihres Fernsehers.

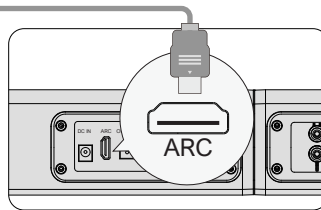

### Schritt 2:

Schließen Sie dann das andere Ende an den ARC-Anschluss der Soundbar an.

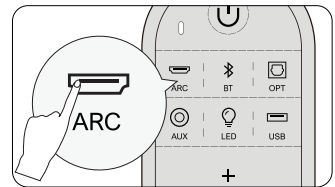

### Schritt 3:

Drücken Sie die "ARC"-Taste auf der Fernbedienung, um den "ARC"-Eingang auszuwählen.

**Wenn kein Ton zu hören ist: Versuchen Sie, den TV-Audioausgang auf PCM einzustellen:**

TV-Einstellungen > Home > Einstellungen > Ton > Digitaler Audioausgang > PCM

**Hinweis: Bitte schalten Sie die "CEC"-Funktion an Ihrem Fernsehgerät ein.**

Wenn ARC angeschlossen ist, kann Ihre TV-Fernbedienung die Soundbar und den Fernseher gleichzeitig steuern:

- 1 Einschalten/Ausschalten
- 2 Lautstärke einstellen

## 6 ANSCHLUSS AN FERNSEHER ÜBER OPTISCH / AUX

### OPTISCH

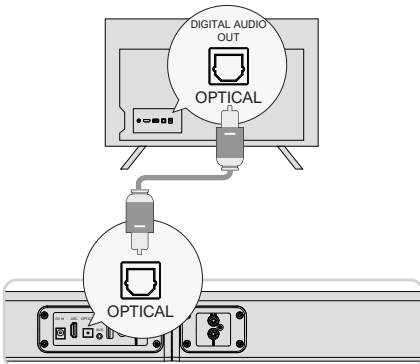

### OPTION 1: OPTICAL

1 Vergewissern Sie sich, dass der Anschluss des Fernsehers auf OPTICAL OUT eingestellt ist, und verbinden Sie beide Seiten des Kabels mit OPTICAL, sowohl für den Fernseher als auch für die Soundbar.

2 Vergewissern Sie sich, dass der optische Stecker richtig eingesteckt ist, wie auf dem Bild zu sehen. Stecken Sie den Stecker nicht verkehrt herum ein, um das optische Kabel nicht zu beschädigen.

**Hinweis:** Wenn der Ton über die internen TV-Lautsprecher wiedergegeben wird, schalten Sie die Lautstärke des Fernsehers stumm oder verringern Sie sie.

### AUX

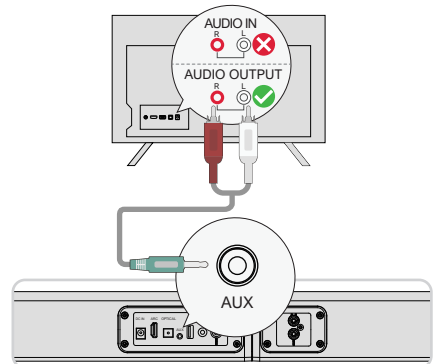

### OPTION 2: AUX

1 Schließen Sie das 3,5-mm-RCA-Audiokabel an den RCA-AUDIO-OUT-Anschluss Ihres Fernsehers an.

2 Achten Sie darauf, dass die Farbe der Kabelenden mit der Farbe der TV-Anschlüsse übereinstimmt.

**Hinweis:** Bitte denken Sie daran, das AUX-Kabel vom Fernseher und der Soundbar zu trennen, wenn Sie in einen anderen Modus wechseln möchten.

**Im optischen Modus: Wenn kein Ton zu hören ist, versuchen Sie, den Audioausgang des Fernsehers auf PCM einzustellen:**

TV-Einstellungen > Home > Einstellungen > Ton > Digitaler Audioausgang > PCM

## 7 VERBINDEN MIT BLUETOOTH®

- 1 Drücken Sie die Taste "⏻" auf der Soundbar oder die Taste "📶" auf der Fernbedienung, um den Bluetooth-Kopplungsmodus zu aktivieren.
- 2 Gehen Sie zu den Bluetooth-Einstellungen auf Ihrem Telefon, suchen Sie "Apollo S40" und wählen Sie es aus, um die Soundbar zu verbinden.

**Hinweis:** Wenn sich die Soundbar bereits im Bluetooth-Modus befindet und verbunden ist, halten Sie die Taste "📶" 3 Sekunden lang gedrückt, um die Verbindung zum aktuellen Gerät zu trennen und Wählen Sie auf Ihrem Mobiltelefon / PC / Fernseher manuell die Verbindung zu einem neuen Gerät.

DE

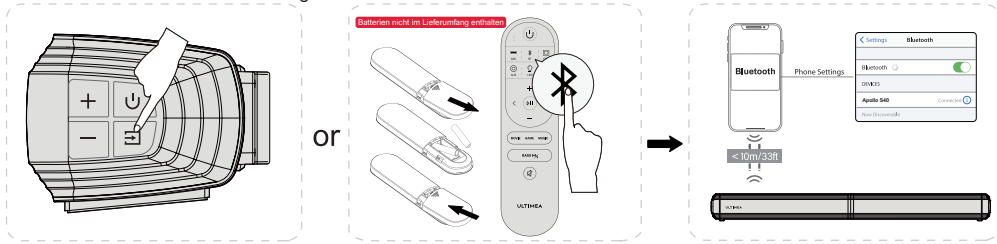

## 8 AUFSTELLUNGSOPTIONEN

### Losgelöst und auf Sockel stehend

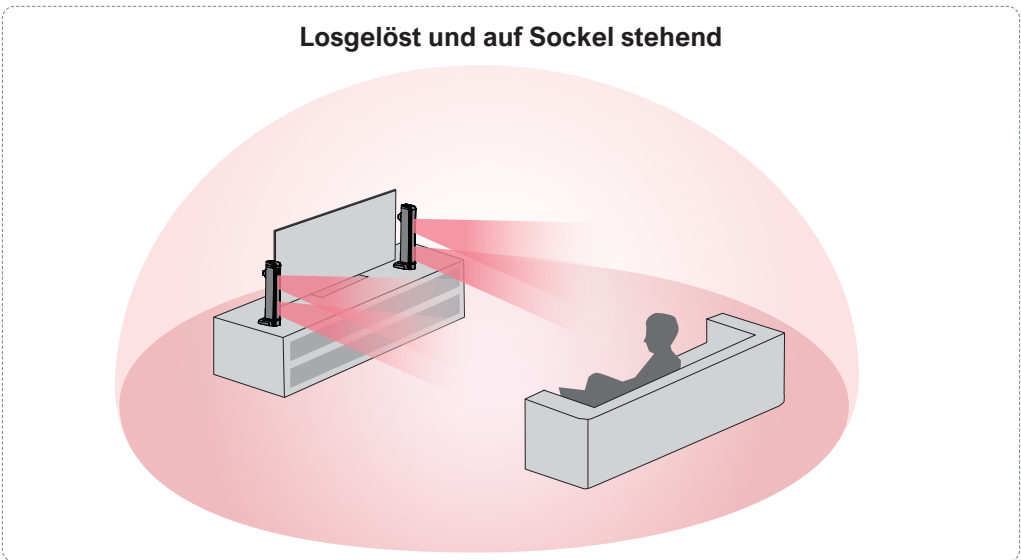

### Horizontale Aufstellung

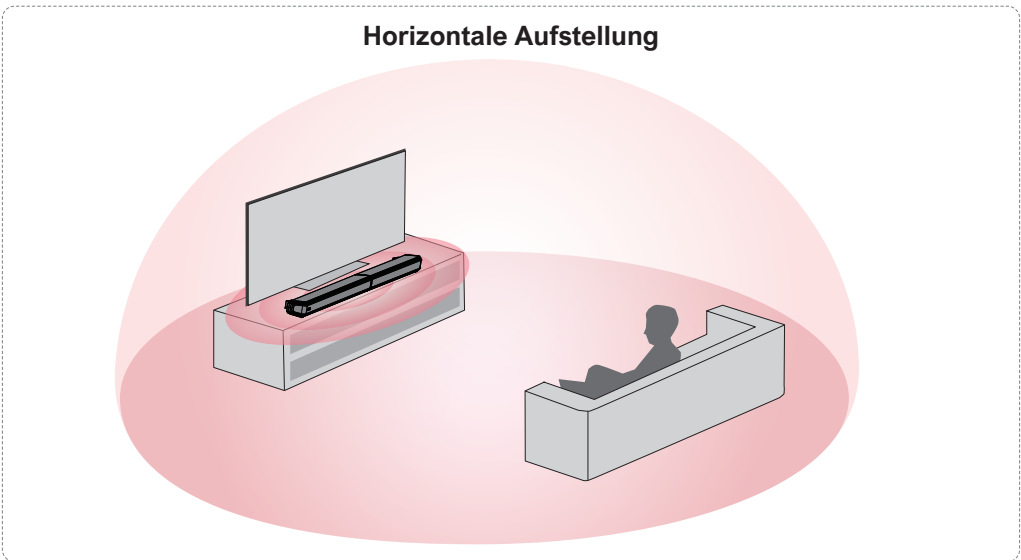

**Hinweis:** Die Soundbar sollte in Ohrhöhe oder in der Nähe des Ohres aufgestellt werden.

## 9 WANDMONTAGE

DE

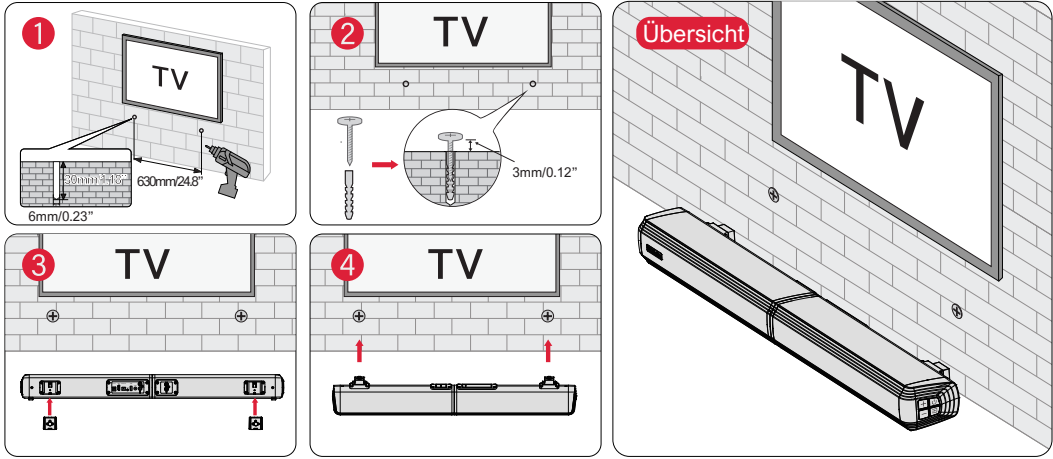

## 10 SPEZIFIKATIONEN

Modell Nummer	U3300
Stromversorgung	AC 100-240V, ~50/60Hz
Soundbar-Treiber	2.25" x 4 (Soundbar)
Frequenzgang	45Hz - 18kHz
Standby-Leistung	<0.5W
Betriebstemperatur	0°C - 45°C/32°F - 113°F
Bluetooth-Version	5.3

Abmessungen und Gewicht	
Soundbar	811(W) × 98(D) × 70(H)
Verpackung	436(W) × 270(D) × 156(H)
Nettogewicht	2.3kg / 5.07lbs
Bruttogewicht	3.6kg / 7.94lbs

ULTIMEA

Apollo S40

# ユーザー取扱説明書

うちはご支援  
させていただ  
く準備が整い  
ております



support@ultimea.com

JP



モデル番号: U3300

ビデオチュートリアル  
をご希望ですか?

設定方法のビデオ、或いは  
ULTIMEAホームページの取扱  
説明書をご参照ください。

@ultimea\_official



support.ultimea.com

+1 888-598-8875 (US) Mon-Fri 9am-5pm (PST)  
 +49 89-628-25828 (EU) Mon-Fri 9am-5pm (CET)

## 1 付属品リスト



サウンドバー

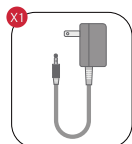

電源アダプター

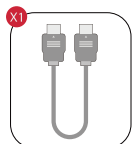

HDMIケーブル

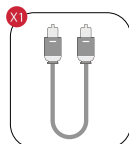

光デジタルケーブル

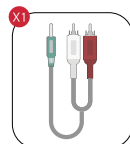

3.5mm - RCAオーディオケーブル

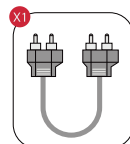

RCA - RCAオーディオケーブル(100mm)

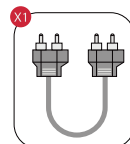

RCA - RCAオーディオケーブル(2.5m)

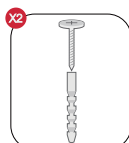

壁掛けネジキット

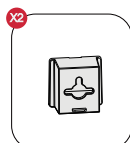

壁掛け固定スタンド



リモコン

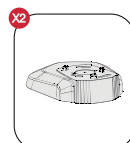

固定用ベース



ユーザーマニュアル

## 2 サウンドバーコントロール

### コントロールパネル

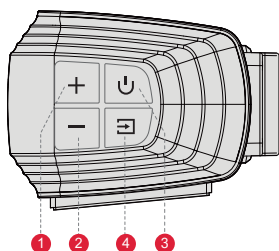

- ① VOL+: ボリュームアップ
- ② VOL-: ボリュームダウン
- ③ 電源ボタン:  
一回押しすと電源が入り、3秒間押し続けると電源が切れます。
- ④ 入力ソース:  
押してチャンネルを切り替える: arc-opt(optcal)-bt-aux-usb。  
3秒間長押しすると、現在のデバイスが切断され、スマホ/PC/TV (BT ID: Apollo S40) の新しいデバイスに手動で接続されます。

## リモコン

- 1 “**U**”：電源ボタン  
3秒押すと電源on/off。
- 2 “**ARC**”：ARC  
押すとHDMI/ARCに切り替えます。
- 3 “**BT**”：BT  
押すとBluetoothに切り替え、ペアリングモードに入ります。  
3秒間長押しすると、現在のデバイスが切断され、携帯電話/PC/TV  
(BT ID: Apollo S40)で新しいデバイスに手動で接続されます。
- 4 “**OPT**”：OPT  
押すとOPTICALに切り替えます。
- 5 “**AUX**”：AUX  
押すとAUXに切り替えます。
- 6 “**LED**”：LED  
押すとLEDライト開ける、再び押すと消灯します。
- 7 “**USB**”：USB  
押すとUSBに切り替わります。
- 8 “**+**”：ボリュームアップ
- 9 “**-**”：ボリュームダウン
- 10 “**<**”：前  
BTおよびUSBモードのみ 前のトラックにスキップする。
- 11 “**>**”：次へ  
BTおよびUSBモードのみ： 次のトラックにスキップします。
- 12 “**▶||**”：再生 / 一時停止  
BTおよびUSBモードのみ  
USBモード： 3秒間長押しすると、単一曲循環再生とリスト循環再生  
が切り替わります。
- 13 “**MOVIE**”：映画  
押すと映画モードに切り替わり：“E9 1”と表示されます。
- 14 “**GAME**”：ゲーム  
押すとゲームモードに切り替わり：“E9 2”と表示されます。
- 15 “**MUSIC**”：音楽  
押すと音楽モードに切り替わり：“E9 3”と表示されます。
- 16 “**BASS MX**”：バスマックス  
押してベースの音量を調節します：“b5- f”、“b5 0”、“b5 f”。
- 17 “**🔇**”：音量ミュート / リストア。

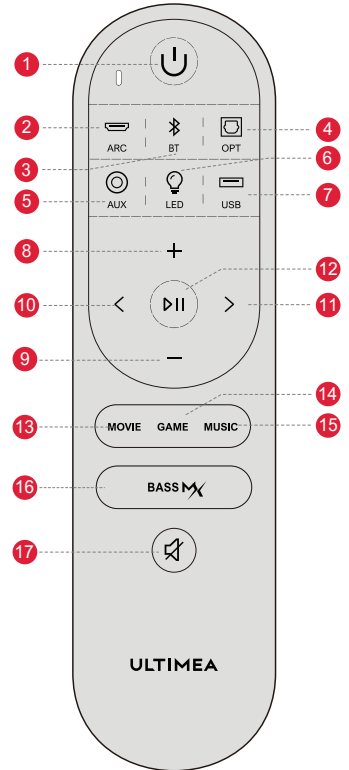

## 3 サウンドバーの設置

### 組み立ての手順:

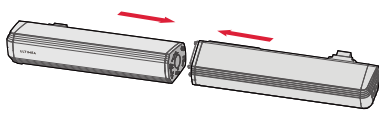
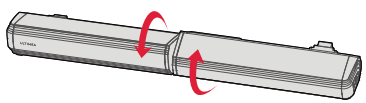
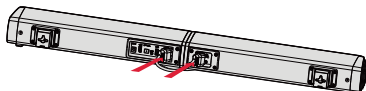
- 1 2つのパーツの接合部を合わせます。  

- 2 ねじって接続します。  

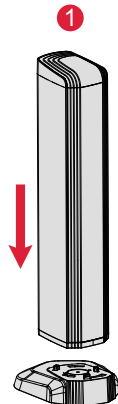
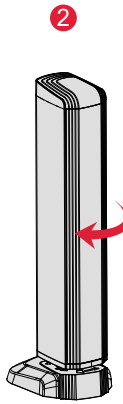
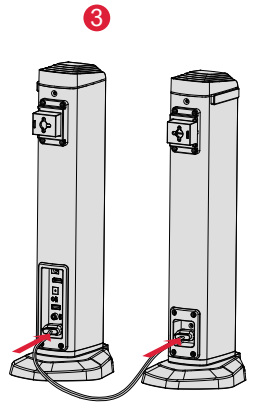
- 3 ステレオRCA-RCAオーディオケーブルを差し込みます。  

### サウンドバーを取り外し、ベースの上に置きます:

- 1  サウンドバーをベースにセットし、接合部を合わせます。
- 2  ねじってベースと接続します。
- 3  ステレオRCA-RCAオーディオケーブルを差し込みます。

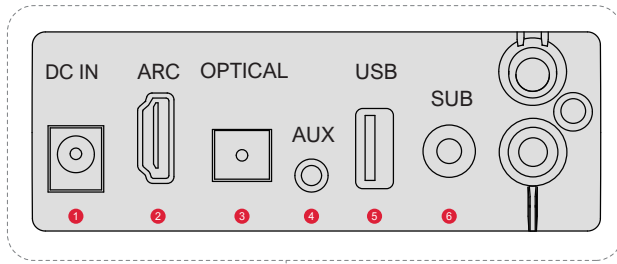

## 4 リアパネル



- ① DC IN
- ② HDMI ARC OUT
- ③ OPTICAL IN
- ④ AUX IN
- ⑤ USBポート:

MP3に対応し、最大64GBのファイルを保存できます。

- ⑥ SUB OUT:
- アクティブ・サブウーファー（別売り）に接続

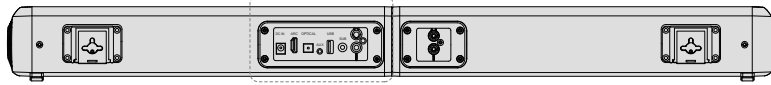

JP

## 5 HDMI OUT ARC でテレビに接続

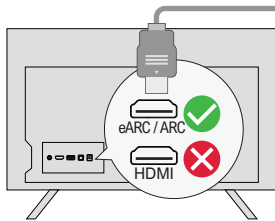

**ステップ1:**  
HDMIケーブルの一端をテレビ背面のeARC / ARCポートに接続します。

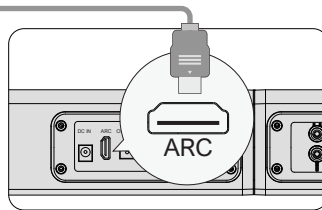

**ステップ2:**  
もう一方の端子をサウンドバーのARCポートに接続します。

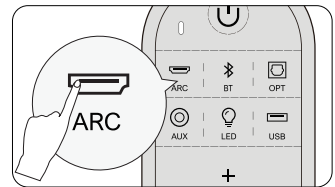

**ステップ3:**  
リモコンの「ARC」ボタンを押して「ARC」入力を選択します。

**音が出ない場合:** テレビの音声出力をPCMに設定してみてください。  
テレビの設定 > ホーム > 設定 > サウンド > デジタル音声出力 > PCM

**注:** テレビの「CEC」機能をオンにしてください。

eARC / ARCが接続されている場合、テレビのリモコンでサウンドバーとテレビを同時に操作できます:

- ① オン/オフ
- ② 音量を調整する

## 6 オプティカル/AUXでテレビに接続

### OPTICAL

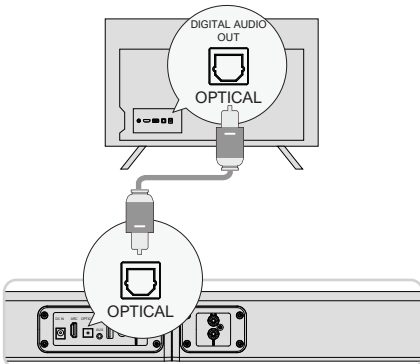

#### 接続方法1: OPTICAL

- ① テレビのポートがOPTICAL OUTであることを確認し、ケーブルの両側をテレビとサウンドバーの両方でOPTICALに接続します。
- ② ードの差し込み口が写真のように正しく差し込まれていることを確認してください。（間違っていると破損する恐れがあります）

**注:** 接続した後、テレビのスピーカーからも音声が再生される場合は、テレビの音量をミュートまたは最小にしてください。

### AUX

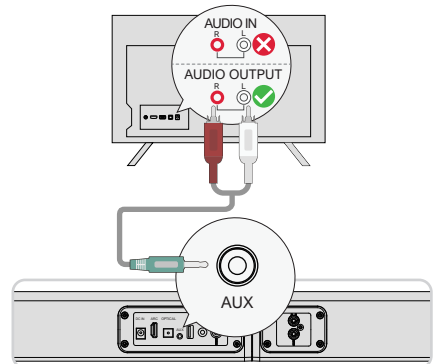

#### 接続方法2: AUX

- ① 3.5mmオーディオケーブルをテレビのRCA AUDIO OUTポートに接続します。
- ② ケーブルの端の色がテレビのポートの色と一致していることを確認してください。

**注:** 他のモードに切り替える場合は、テレビとサウンドバーからAUXケーブルを抜いてください。

**オプティカルモード:** 音が出ない場合は、テレビの音声出力をPCMに設定してください。  
TV設定 > ホーム > 設定 > サウンド > デジタル音声出力 > PCM

## 7 Bluetooth® への接続

- 1 サウンドバーの"Bluetooth"ボタンを押すか、リモコンの"Bluetooth"ボタンを押してBluetoothペアリングモードに入ります。
  - 2 携帯電話のBluetooth設定に移動し、"Apollo S40"を見つけて選択し、サウンドバーを接続します。
- 注: すでにBluetoothモードで接続されている場合は、"Bluetooth"ボタンを3秒間長押しして現在のデバイスを切断し、新しいデバイスに手動で接続することを選択します。を選択し、携帯電話/PC/TVで手動で新しいデバイスに接続します。

JP

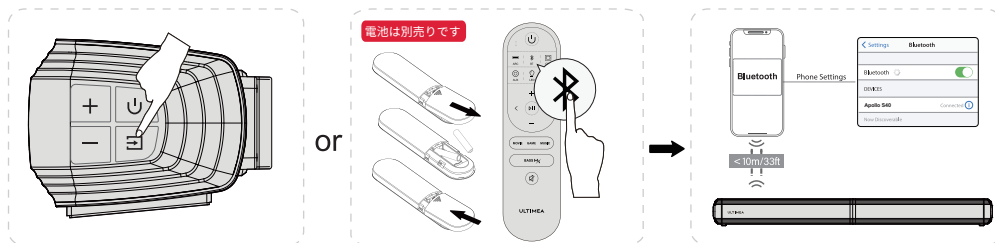

## 8 配置に関する提案

### 取り外して台座に立てる

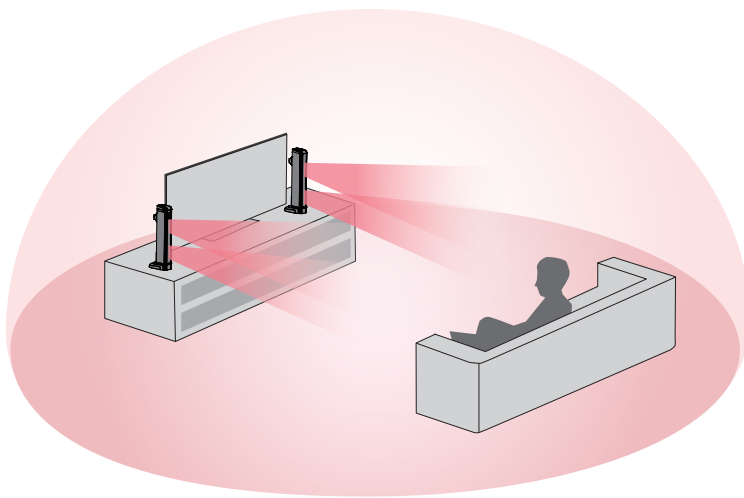

### 横置き

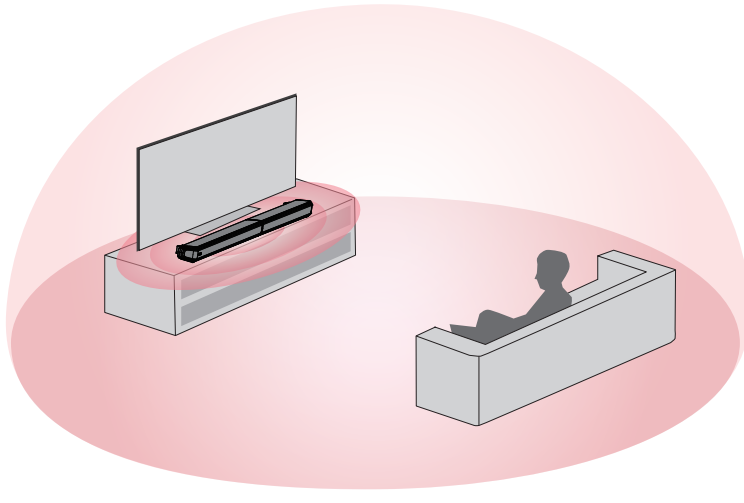

注: サウンドバーは耳の高さか、その近くに設置してください。

## 9 壁掛け

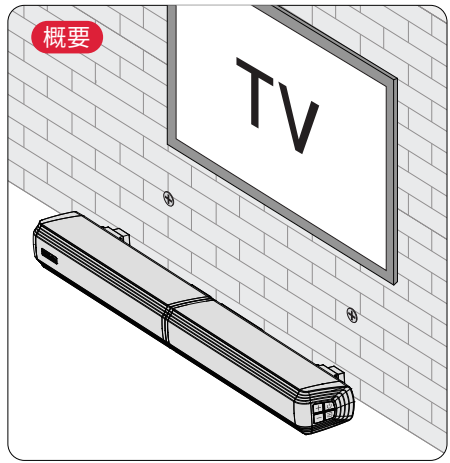
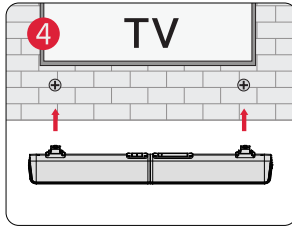
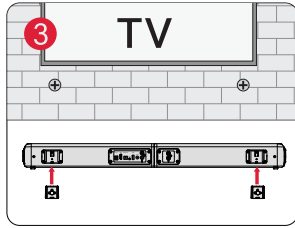
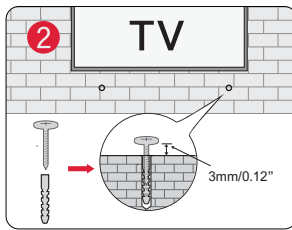
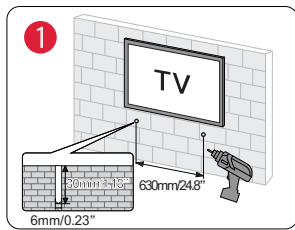

JP

## 10 仕様

モデル番号	U3300
電源供給	AC 100-240V, ~50/60Hz
サウンドバードライバー	2.25ch x 4 (サウンドバー)
周波数帯域	45Hz - 18kHz
待機電力	<0.5W
動作温度	0°C - 45°C/32°F - 113°F
Bluetoothバージョン	5.3

寸法と重量	
サウンドバー	811(W) × 98(D) × 70(H)
包装	436(W) × 270(D) × 156(H)
正味重量	2.3kg / 5.07lbs
総重量	3.6kg / 7.94lbs

ULTIMEA

Apollo S40

# Manuel d'utilisation

FR

## NOUS SOMMES PRÊTS À VOUS AIDER



support@ultimea.com



Numéro de modèle: U3300

### Vous préférez un tutoriel vidéo ?

Vidéo d'aide à l'installation, ou MANUEL D'UTILISATION sur le site web d'ULTIMEA.



@ultimea\_official



support.ultimea.com

+1 888-598-8875 (US) Mon-Fri 9am-5pm (PST)  
+49 89-628-25828 (EU) Mon-Fri 9am-5pm (CET)

## 1 LISTE DES ACCESSOIRES



### Barre de son

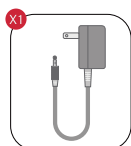

Adaptateur d'alimentation

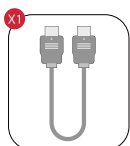

Câble HDMI

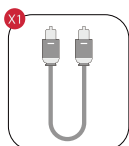

Câble optique numérique

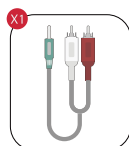

Câble audio stéréo RCA vers 3,5 mm

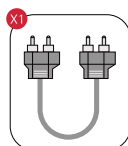

Câble audio stéréo RCA vers RCA (100 mm)

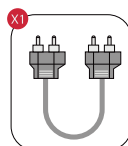

Câble audio stéréo RCA vers RCA (2,5m)

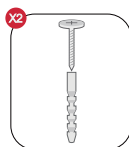

Kit de montage mural

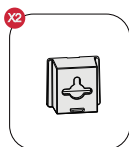

Support mural



Télécommande

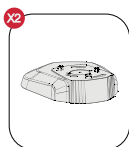

Socle



Manuel de l'utilisateur

## 2 COMMANDES DE LA BARRE DE SON

### Panneau de contrôle

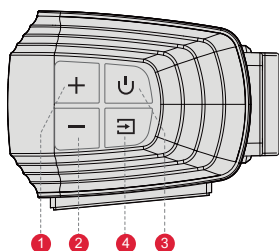

1 **VOL+**: Augmenter le volume

2 **VOL-**: Réduction du volume

3 **Bouton d'alimentation**:

Appuyez sur ce bouton pour allumer l'appareil / Maintenez-le enfoncé pendant 3 secondes pour l'éteindre.

4 **SOURCE**:

Appuyez sur cette touche pour changer de chaîne : ARC-OPT(OPTICAL)-BT-AUX-USB.

Maintenez cette touche enfoncée pendant 3 secondes pour déconnecter l'appareil actuel et le connecter manuellement à un nouvel appareil sur votre téléphone portable / PC / TV (BT ID : Apollo S40).

## Télécommande

- 1 “⏻” : **Bouton d'alimentation**  
Appuyer pour allumer / Maintenir pendant 3 secondes pour éteindre.
- 2 “⏮” : **ARC**  
Appuyez sur cette touche pour passer au canal HDMI ARC.
- 3 “📶” : **BT**  
Appuyez sur cette touche pour passer au canal Bluetooth et entrer en mode d'appairage.  
Maintenez cette touche enfoncée pendant 3 secondes pour déconnecter l'appareil actuel et le connecter manuellement à un nouvel appareil sur votre téléphone portable / PC / TV (BT ID : Apollo S40).
- 4 “📺” : **OPT**  
Appuyez sur cette touche pour passer au canal OPTICAL.
- 5 “🎧” : **AUX**  
Appuyez sur cette touche pour passer au canal AUX.
- 6 “💡” : **LED**  
Appuyez sur cette touche pour éteindre la LED, appuyez à nouveau sur cette touche pour l'allumer.
- 7 “📀” : **USB**  
Appuyez sur cette touche pour passer au canal USB.
- 8 “+” : **Augmentation du volume**
- 9 “-” : **Diminution du volume**
- 10 “⏪” : **Précédent**  
Pour les modes BT et USB uniquement : Passer à la piste précédente.
- 11 “⏩” : **Suivant**  
Pour les modes BT et USB uniquement : Passer à la piste suivante.
- 12 “⏸” : **Lecture / Pause**  
Pour les modes BT et USB uniquement.  
Mode USB : Maintenez cette touche enfoncée pendant 3 secondes pour basculer entre la lecture d'une seule boucle et la lecture d'une liste de boucles.
- 13 “MOVIE” : **MOVIE**  
Appuyez sur cette touche pour passer en mode MOVIE, l'écran affiche: “EQ 1”.
- 14 “GAME” : **JEU**  
Appuyez sur cette touche pour passer en mode JEU, l'écran affichera: “EQ 2”.
- 15 “MUSIC” : **MUSIQUE**  
Appuyez sur cette touche pour passer en mode MUSIQUE, l'écran affiche: “EQ 3”.
- 16 “BASS MAX” : **BASSMAX**  
Appuyez sur cette touche pour régler le niveau des basses, l'écran affiche: “b5- 1”, “b5 0”, “b5 1”.
- 17 “🔇” : **Mute / Récupérer le volume.**

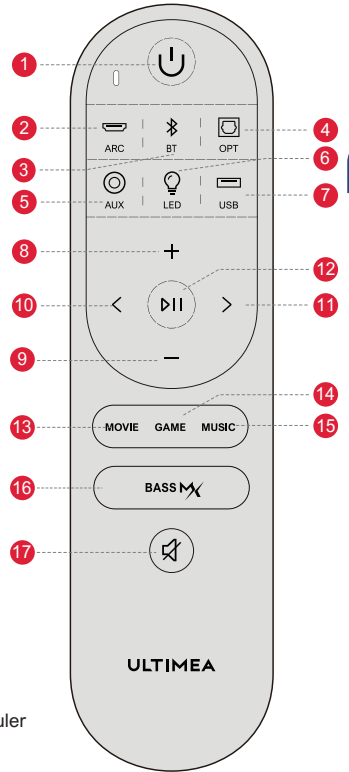

FR

## 3 INSTALLATION DE LA BARRE DE SON

### Étapes de l'assemblage :

- 1 Aligner les joints des deux parties.

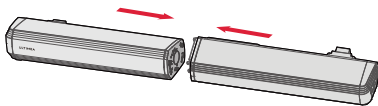

- 2 Tourner pour connecter.

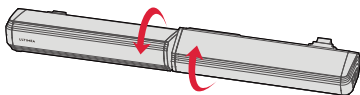

- 3 Brancher le câble audio stéréo RCA vers RCA.

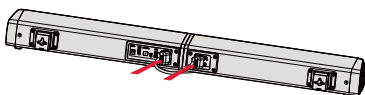

### Détachée et posée sur la base :

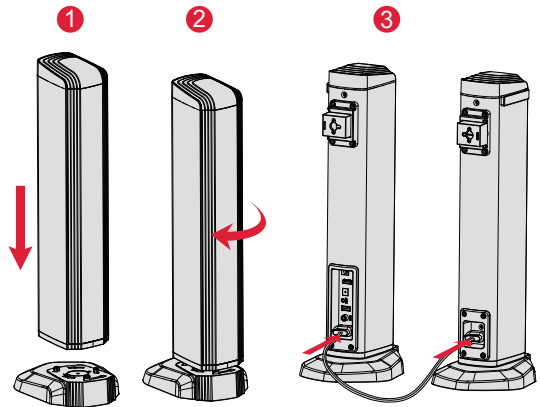

- 1 Placer la barre de son sur la base et aligner les joints.
- 2 Tourner pour connecter à la base.
- 3 Brancher le câble audio stéréo RCA à RCA.

## 4 PANNEAU ARRIÈRE

FR

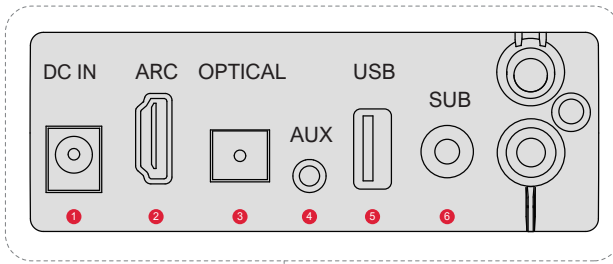

- ❶ DC IN
- ❷ SORTIE HDMI ARC
- ❸ ENTRÉE OPTIQUE
- ❹ ENTRÉE AUXILIAIRE
- ❺ Port USB :

Prend en charge les fichiers MP3 avec une mémoire maximale de 64 Go.

- ❻ SUB OUT:

Permet de connecter un caisson de basse actif (non inclus).

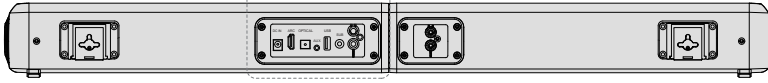

## 5 CONNECTER AU TÉLÉVISEUR VIA ARC

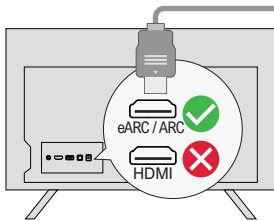

### Étape 1:

Connectez une extrémité du câble HDMI au port eARC / ARC à l'arrière de votre téléviseur.

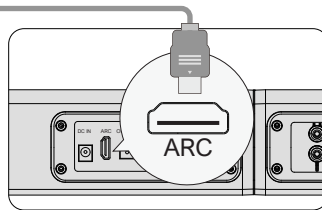

### Étape 2:

Connectez ensuite l'autre extrémité au port ARC de la barre de son.

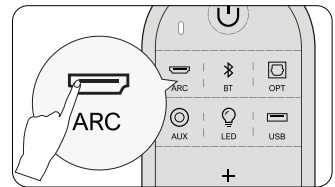

### Étape 3:

Appuyez sur la touche "ARC" de la télécommande pour sélectionner l'entrée "ARC".

**S'il n'y a pas de son : essayez de régler la sortie audio du téléviseur sur PCM:**

Réglages du téléviseur > Accueil > Réglages > Son > Sortie audio numérique > PCM

**Remarque : Activez la fonction "CEC" sur votre téléviseur.**

Lorsque l'entrée ARC est connectée, la télécommande de votre téléviseur peut contrôler simultanément la barre de son et le téléviseur : ❶ Allumer/éteindre ❷ Régler le volume

## 6 CONNEXION AU TÉLÉVISEUR VIA OPTIQUE / AUX

### OPTIQUE

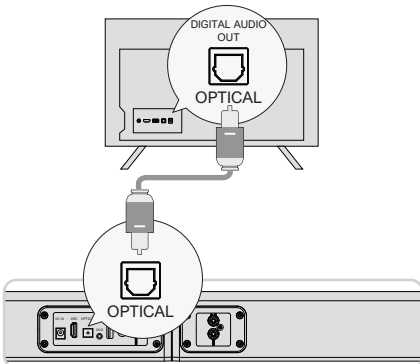

### OPTION 1 : OPTIQUE

- ❶ Assurez-vous que le port du téléviseur est OPTICAL OUT, connectez les deux côtés du câble à OPTICAL, à la fois pour le téléviseur et la barre de son.
- ❷ Assurez-vous que la prise optique est insérée correctement, comme indiqué sur l'image. N'insérez pas la fiche à l'envers et ne cassez pas le câble optique.

**Remarque:** Si le son est diffusé par les haut-parleurs internes du téléviseur, mettez le volume du téléviseur en sourdine ou réduisez-le au minimum.

### AUX

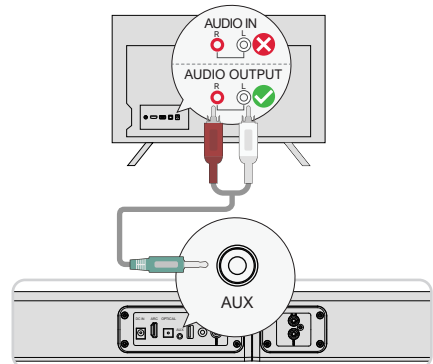

### OPTION 2: AUX

- ❶ Connectez le câble audio 3,5 mm vers RCA au port RCA AUDIO OUT de votre téléviseur.
- ❷ Assurez-vous que la couleur des extrémités du câble correspond à la couleur des ports du téléviseur.

**Remarque:** N'oubliez pas de débrancher le câble AUX de la télévision et de la barre de son lorsque vous souhaitez passer à un autre mode.

**En mode optique : S'il n'y a pas de son, essayez de régler la sortie audio du téléviseur sur PCM:**  
Réglages du téléviseur > Accueil > Réglages > Son > Sortie audio numérique > PCM

## 7 CONNEXION AU BLUETOOTH®

1 Appuyez sur le bouton " " de la barre de son ou appuyez sur le bouton " " de la télécommande pour entrer dans le mode d'appairage Bluetooth.

2 Allez dans les paramètres Bluetooth de votre téléphone, trouvez et sélectionnez "Apollo S40" pour connecter la barre de son.

**Remarque:** Si la barre de son est déjà en mode Bluetooth et connectée, appuyez sur le bouton " " pendant 3 secondes pour déconnecter l'appareil actuel et choisissez de vous connecter à un nouvel appareil manuellement sur votre téléphone portable / PC / TV.

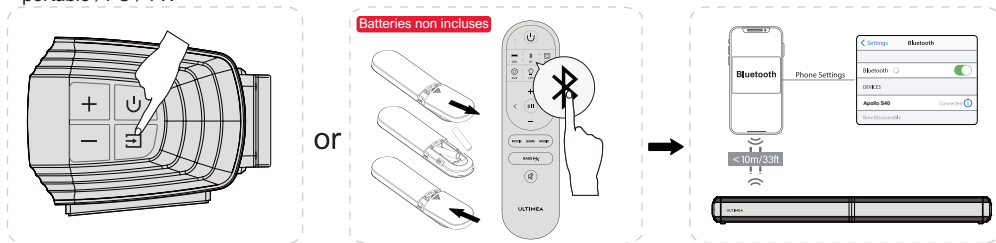

## 8 OPTIONS DE PLACEMENT

### Détacher et se tenir sur la base

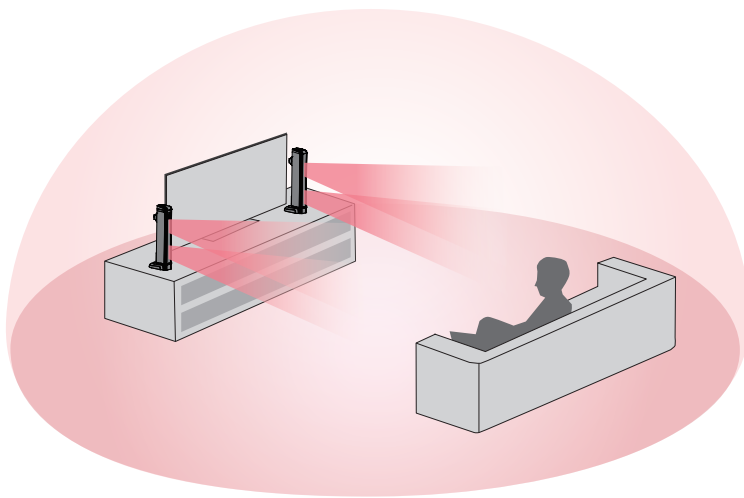

### Placement horizontal

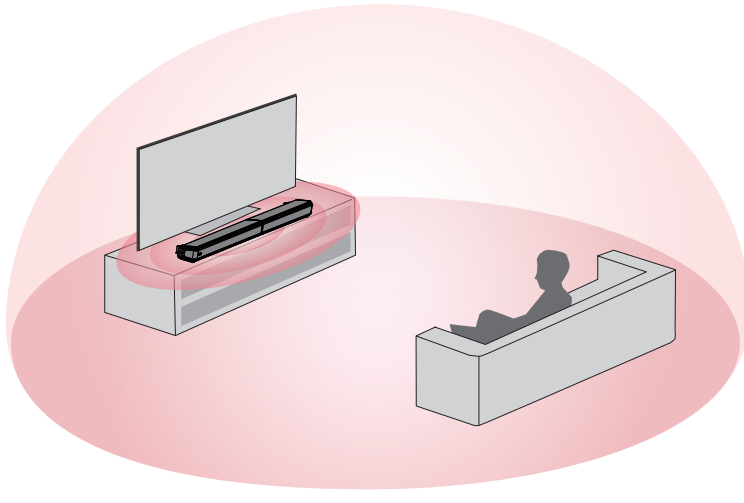

**Remarque :** La barre de son doit être placée à hauteur d'oreille ou presque.

## 9 INSTALLATION MURALE

FR

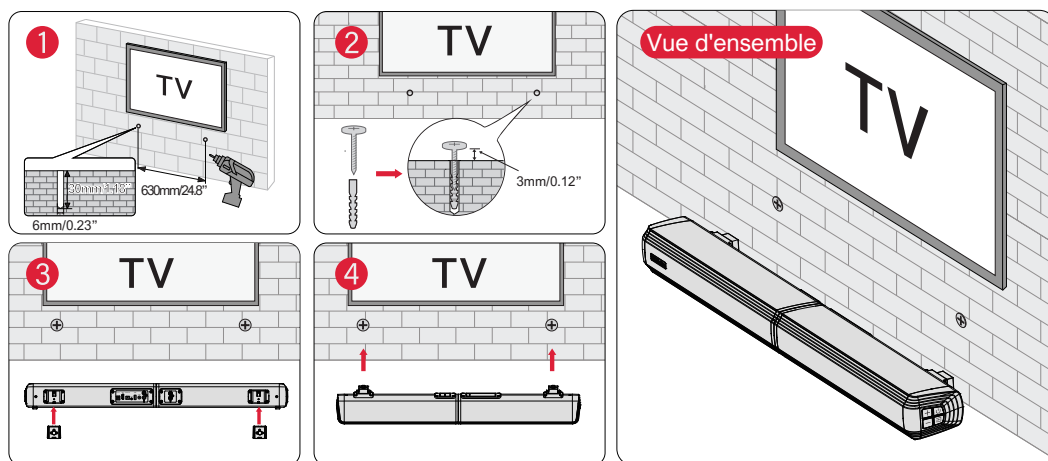

## 10 SPÉCIFICATIONS

Numéro de modèle	U3300
Alimentation Électrique	AC 100-240V, ~50/60Hz
Pilotes de la barre de son	2.25" x 4 (barre de son)
Réponse en fréquence	45Hz - 18kHz
Puissance en veille	<0.5W
Température de fonctionnement	0°C - 45°C/32°F - 113°F
Version Bluetooth	5.3

Dimensions et poids	
Barre de son	811(W) x 98(D) x 70(H)
Emballage	436(W) x 270(D) x 156(H)
Poids net	2.3kg / 5.07lbs
Poids brut	3.6kg / 7.94lbs



ULTIMEA

Apollo S40

# Manuale d'uso

## SIAMO PRONTI AD AIUTARE



support@ultimea.com



Numero di modello: U3300

### Preferite un video tutorial?

Video guida all'installazione o MANUALE D'USO sul sito web di ULTIMEA.



@ultimea\_official



support.ultimea.com

+1 888-598-8875 (US) Mon-Fri 9am-5pm (PST)  
+49 89-628-25828 (EU) Mon-Fri 9am-5pm (CET)

## 1 ELENCO ACCESSORI



### Soundbar

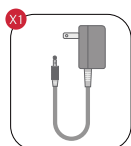

Adattatore di alimentazione

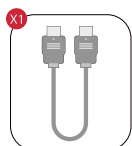

Cavo HDMI

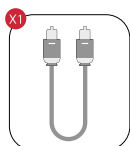

Câble optique numérique

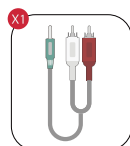

Cavo audio stereo da 3,5 mm a RCA

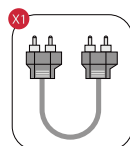

Cavo audio stereo da RCA a RCA (100 mm)

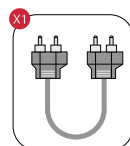

Cavo audio stereo da RCA a RCA (2,5 m)

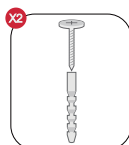

Kit per il montaggio a parete

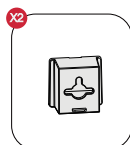

Staffa a muro



Telecomando

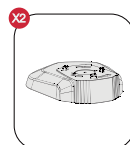

Base



Manuale d'uso

## 2 CONTROLLI DELLA SOUNDBAR

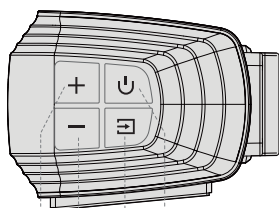

1 2 4 3

### Pannello di controllo

- 1 **VOL+**: Volume su
- 2 **VOL-**: Volume giù
- 3 **Pulsante di accensione**:  
Premere per accendere / Tenere premuto per 3 secondi per spegnere.
- 4 **FONTE**:  
Premere per cambiare canale: ARC-OPT(OPTICAL)-BT-AUX-USB.  
Tenere premuto per 3 secondi per scollegare il dispositivo corrente e collegarlo manualmente a un nuovo dispositivo sul cellulare / PC / TV (ID BT: Apollo S40).

## Telecomando

- 1 “**U**”: **Pulsante di accensione**  
Premere per accendere / Tenere premuto per 3 secondi per spegnere.
- 2 “**ARC**”: **ARC**  
Premere per passare al canale HDMI ARC.
- 3 “**BT**”: **BT**  
Premere per passare al canale Bluetooth e accedere alla modalità di accoppiamento.  
Tenere premuto per 3 secondi per scollegare il dispositivo corrente e collegarlo manualmente a un nuovo dispositivo sul telefono cellulare / PC / TV (ID BT: Apollo S40).
- 4 “**OPT**”: **OPT**  
Premere per passare al canale OTTICO.
- 5 “**AUX**”: **AUX**  
Premere per passare al canale AUX.
- 6 “**LED**”: **LED**  
Premere per spegnere il LED, premere nuovamente per accenderlo.
- 7 “**USB**”: **USB**  
Premere per passare al canale USB.
- 8 “**+**”: **Volume su**
- 9 “**-**”: **Volume giù**
- 10 “**<**”: **Precedente**  
Solo per la modalità BT e USB: Passa al brano precedente.
- 11 “**>**”: **successivo**  
Solo per la modalità BT e USB: Passa alla traccia successiva.
- 12 “**▶||**”: **Riproduzione / Pausa**  
Solo per la modalità BT e USB.  
Modalità USB: Tenere premuto per 3 secondi per passare dalla riproduzione di un singolo loop alla riproduzione di un elenco di loop.
- 13 “**MOVIE**”: **FILMATO**  
Premere per passare alla modalità MOVIE; il display visualizza: “E9 I”.
- 14 “**GAME**”: **GAME**  
Premere per passare alla modalità GAME, il display visualizza: “E9 2”.
- 15 “**MUSIC**”: **MUSIC**  
Premere per passare alla modalità MUSIC, il display visualizza: “E9 3”.
- 16 “**BASS MAX**”: **BASSMAX**  
Premere per regolare il livello dei bassi; il display visualizza: “b5- I”, “b5 II”, “b5 I”.
- 17 “**🔇**”: **Silenziamento / Recupero del volume.**

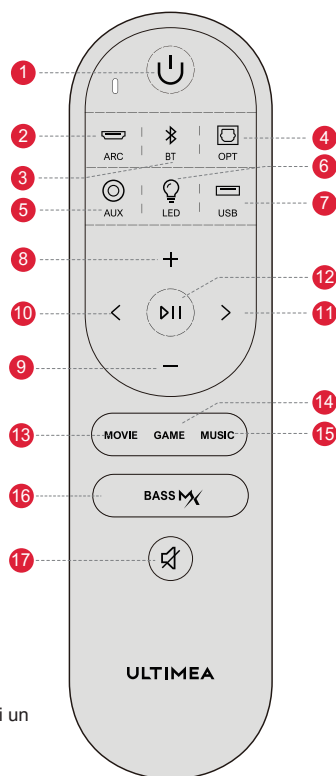

## 3 INSTALLAZIONE DELLA SOUNDBAR

### Fasi di montaggio:

- 1 Allineare i giunti delle due parti.
- 2 Ruotare per collegare.
- 3 Collegare il cavo audio stereo da RCA a RCA.

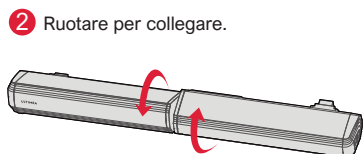
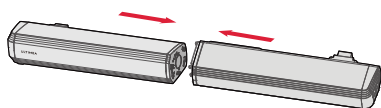

### Staccare la soundbar e posizionarla sulla base:

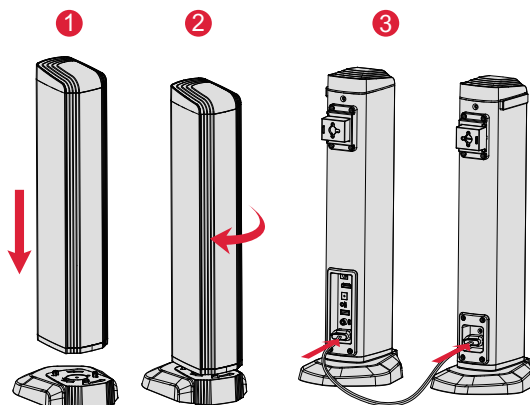

- 1 Posizionare la soundbar sulla base e allineare i giunti.
- 2 Ruotare per collegarla alla base.
- 3 Inserire il cavo audio stereo da RCA a RCA.

## 4 PANNELLO POSTERIORE

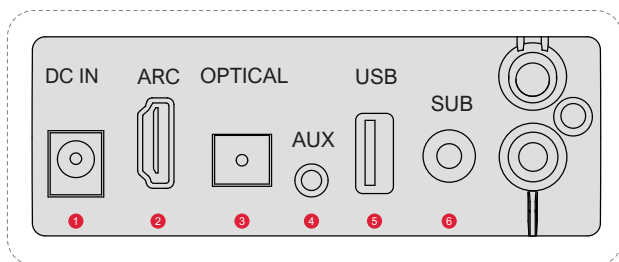

- 1 **INGRESSO CC**
- 2 **USCITA HDMI ARC**
- 3 **INGRESSO OTTICO**
- 4 **INGRESSO AUX**
- 5 **Porta USB:**

Supporta i file MP3 con una memoria massima di 64 GB.

- 6 **SUB OUT:**

Consente di collegare il subwoofer attivo (non incluso).

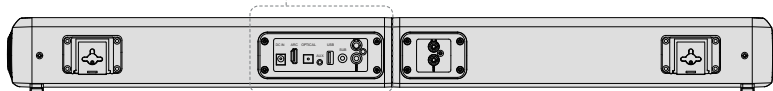

## 5 COLLEGAMENTO ALLA TV VIA ARCO

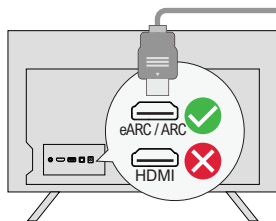

### Passo 1:

Collegare un'estremità del cavo HDMI alla porta eARC / ARC sul retro del televisore.

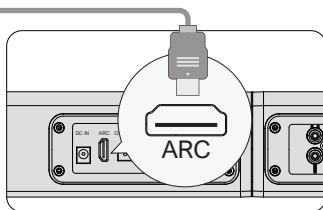

### Passo 2:

Collegare quindi l'altra estremità alla porta ARC della soundbar.

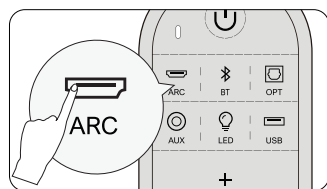

### Passo 3:

Premere il pulsante "ARC" sul telecomando per selezionare l'ingresso "ARC".

**Se non c'è suono: provare a impostare l'uscita audio del televisore su PCM:**

Impostazioni TV > Home > Impostazioni > Suono > Uscita audio digitale > PCM

**Nota: attivare la funzione "CEC" sul televisore.**

Quando l'ARC è collegato, il telecomando del televisore può controllare contemporaneamente la soundbar e il televisore:

- 1 Accendere/spengere
- 2 Regolare il volume

## 6 COLLEGAMENTO ALLA TV VIA OTTICA / AUX

### OTTICO

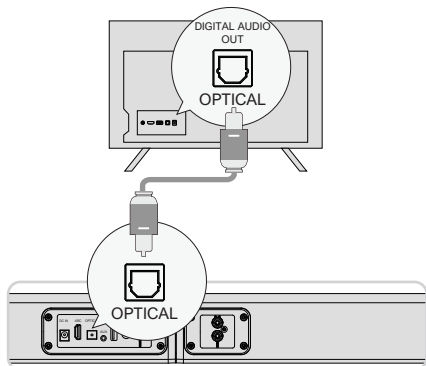

#### OPZIONE 1 : OPTIQUE

- 1 Assicurarsi che la porta del televisore sia OPTICAL OUT, collegare entrambi i lati del cavo a OPTICAL, sia per il televisore che per la soundbar.
- 2 Assicurarsi che la spina ottica sia inserita correttamente come mostrato nell'immagine. Non inserire la spina al contrario e non rompere l'ottica.

**Nota:** se l'audio viene riprodotto dagli altoparlanti interni del televisore, disattivare o ridurre al minimo il volume del televisore.

### AUX

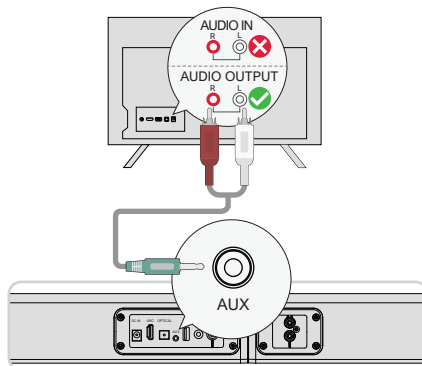

#### OPZIONE 2: AUX

- 1 Collegare il cavo audio da 3,5 mm a RCA alla porta RCA AUDIO OUT del televisore.
- 2 Assicurarsi che il colore delle estremità dei cavi corrisponda a quello delle porte del televisore.

**Nota:** ricordarsi di scollegare il cavo AUX dal televisore e dalla Soundbar quando si desidera passare a un'altra modalità.

**In modalità ottica: Se non si sente alcun suono, provare a impostare l'uscita audio del televisore su PCM:**  
Impostazioni TV > Home > Impostazioni > Audio > Uscita audio digitale > PCM

## 7 CONNESSIONE AL BLUETOOTH®

- 1 Premere il pulsante " " della soundbar o il pulsante " " del telecomando per accedere alla modalità di accoppiamento Bluetooth.
  - 2 Accedere alle impostazioni Bluetooth del telefono, trovare e selezionare "Apollo S40" per collegare la soundbar.
- Nota:** se è già in modalità Bluetooth e collegata, tenere premuto il pulsante " " per 3 secondi per scollegare il dispositivo corrente e scegliere di collegarsi a un nuovo dispositivo manualmente. scegliere di collegarsi a un nuovo dispositivo manualmente sul cellulare / PC / TV.

IT

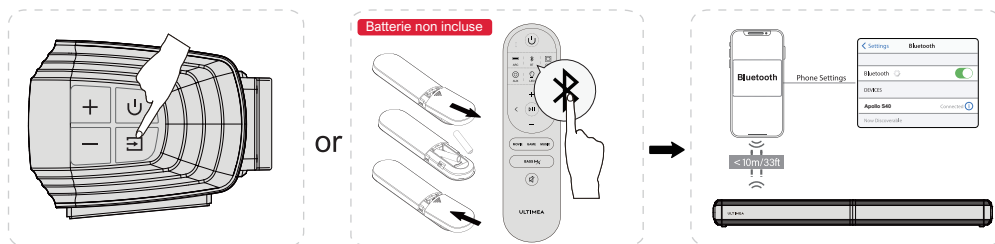

## 8 OPZIONI DI POSIZIONAMENTO

### Staccati e appoggiati alla base

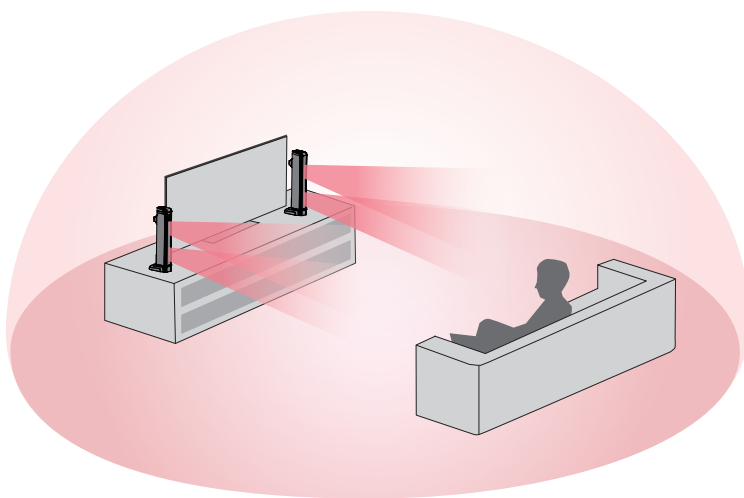

### Posizionamento orizzontale

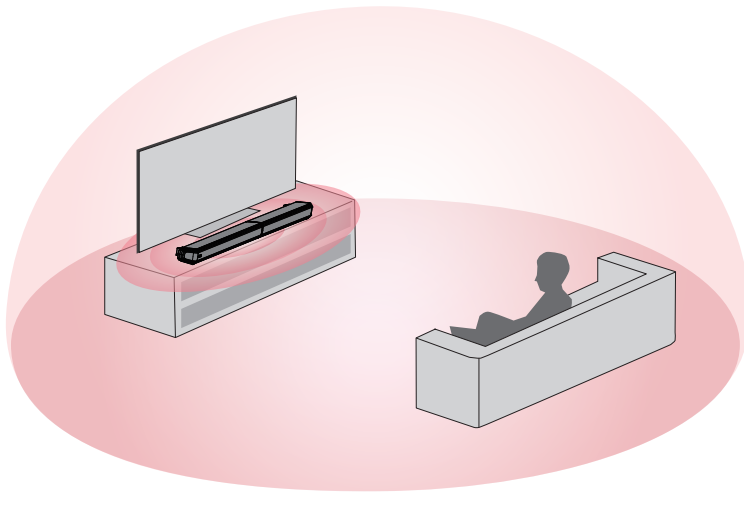

**Nota:** la soundbar deve essere posizionata all'altezza delle orecchie o vicino ad esse.

## 9 INSTALLAZIONE A PARETE

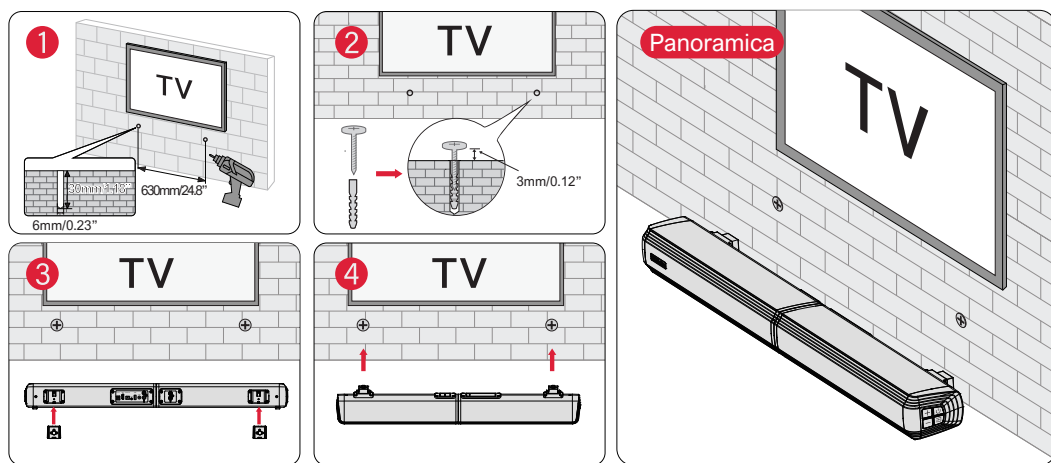

IT

## 10 SPECIFICHE

Numero di modello	U3300
Alimentazione	AC 100-240V, ~50/60Hz
Driver della barra audio	2.25" x 4 (barra audio)
Risposta in frequenza	45Hz - 18kHz
Potenza in standby	<0.5W
Temperatura di esercizio	0°C - 45°C/32°F - 113°F
Versione Bluetooth	5.3

Dimensioni e peso	
Soundbar	811(W) × 98(D) × 70(H)
Imballaggio	436(W) × 270(D) × 156(H)
Peso netto	2.3kg / 5.07lbs
Peso lordo	3.6kg / 7.94lbs

ULTIMEA

Apollo S40

# Manual del usuario

## ESTAMOS LISTOS PARA AYUDAR



support@ultimea.com

ES



Número de modelo: U3300

### ¿Prefiere un tutorial en vídeo?

Vídeo guía de instalación o MANUAL DE USUARIO en el sitio web de ULTIMEA.

@ultimea\_official



support.ultimea.com

+1 888-598-8875 (US) Mon-Fri 9am-5pm (PST)  
+49 89-628-25828 (EU) Mon-Fri 9am-5pm (CET)

## 1 LISTA DE ACCESORIOS

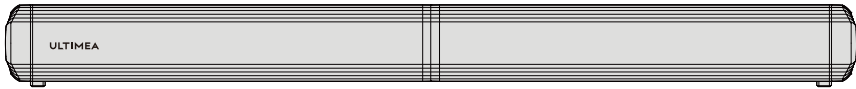

### Barra de sonido



Adaptador de corriente

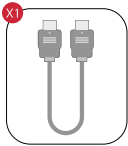

Cable HDMI

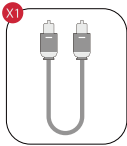

Cable digital óptico

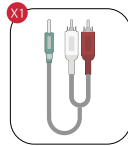

Estéreo de 3,5 mm a RCA Cable de audio

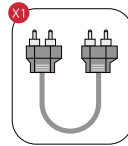

Estéreo RCA a RCA Cable de audio (100 mm)

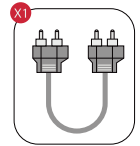

Cable de audio estéreo RCA a RCA (2,5 m)

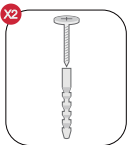

Kit de montaje en pared

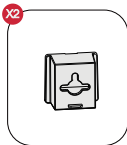

Soporte de pared



Mando a distancia

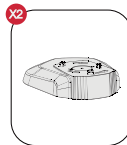

Base



Manual del usuario

## 2 CONTROLES DE LA BARRA DE SONIDO

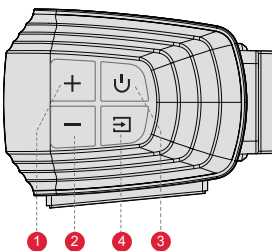

### Panel de control

- 1 **VOL+:** Subir Volumen
- 2 **VOL-:** Bajar Volumen
- 3 **Botón de encendido:** Pulse para encender / Mantenga pulsado durante 3 segundos para apagar.
- 4 **FUENTE:** Pulse para cambiar de canal: ARC-OPT(ÓPTICO)-BT-AUX-USB. Mantenga pulsado durante 3 segundos para desconectar el dispositivo actual y conectarse a un nuevo dispositivo manualmente en su teléfono móvil / PC / TV (BT ID: Apollo S40).

## Mando a distancia

- 1 “⏻”: **Botón de encendido**  
Pulse para encender / Mantenga pulsado durante 3 segundos para apagar.
- 2 “⏮”: **ARC**  
Pulse para cambiar al canal HDMI ARC.
- 3 “📶”: **BT**  
Pulse para cambiar al canal Bluetooth y entrar en el modo de emparejamiento.  
Mantenga pulsado durante 3 segundos para desconectar el dispositivo actual y conectarse a un nuevo dispositivo manualmente en su teléfono móvil / PC / TV (BT ID: Apollo S40).
- 4 “📺”: **OPT**  
Pulse para cambiar al canal OPTICAL.
- 5 “🎧”: **AUX**  
Pulse para cambiar al canal AUX.
- 6 “💡”: **LED**  
Pulse para apagar el LED, pulse de nuevo para encenderlo.
- 7 “📀”: **USB**  
Pulse para cambiar al canal USB.
- 8 “+”: **Subir volumen**
- 9 “-”: **Bajar volumen**
- 10 “<”: **Anterior**  
Sólo para los modos BT y USB: Salta a la pista anterior.
- 11 “>”: **Siguiente**  
Sólo para los modos BT y USB: Salta a la pista siguiente.
- 12 “▶||”: **Reproducir / Pausa**  
Sólo para los modos BT y USB.  
Modo USB: Mantenga pulsado durante 3 segundos para cambiar entre reproducción de bucle simple y reproducción de bucle de lista.
- 13 “MOVIE”: **MOVIE**  
Pulse para cambiar al modo MOVIE, la pantalla mostrará: “E9 1”.
- 14 “GAME”: **JUEGO**  
Pulse para cambiar al modo JUEGO, la pantalla mostrará: “E9 2”.
- 15 “MUSIC”: **MÚSICA**  
Pulse para cambiar al modo MÚSICA, la pantalla mostrará: “E9 3”.
- 16 “BASS MAX”: **BASSMAX**  
Pulse para ajustar el nivel de graves, la pantalla mostrará: “b5- 1”, “b5 0”, “b5 1”.
- 17 “🔇”: **Silenciar / Recuperar el volumen.**

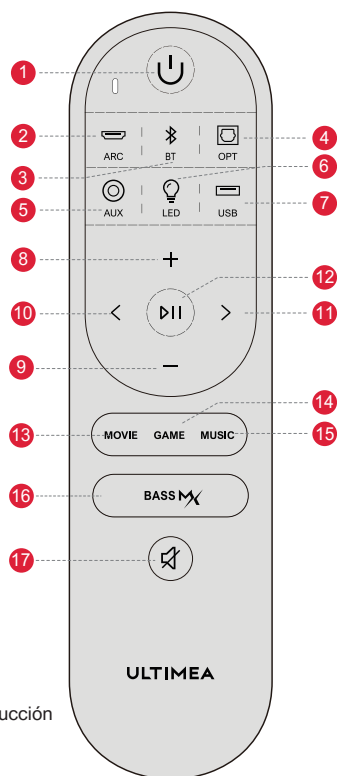

ES

## 3 INSTALACIÓN DE LA BARRA DE SONIDO

### Pasos de montaje:

- 1 Alinee las juntas de las dos partes.

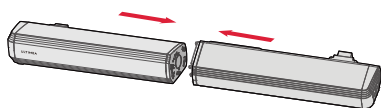

- 2 Gire para conectar.

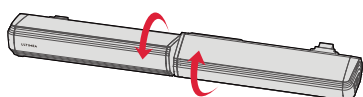

- 3 Enchufe el cable de audio estéreo RCA a RCA.

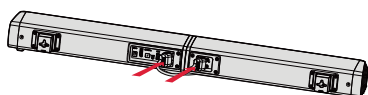

### Desmontaje y colocación en la base:

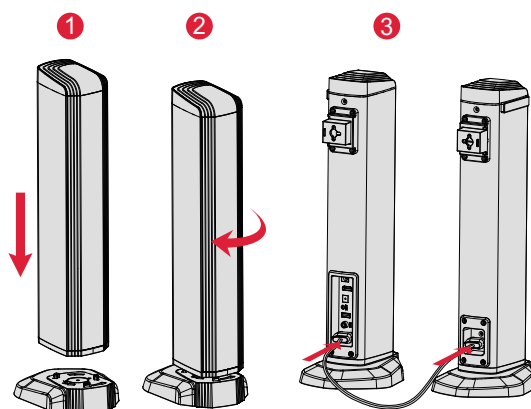

- 1 Coloque la barra de sonido sobre la base y alinee las juntas.
- 2 Gire para conectar con la base.
- 3 Enchufe el cable de audio estéreo RCA a RCA.

## 4 PANEL TRASERO

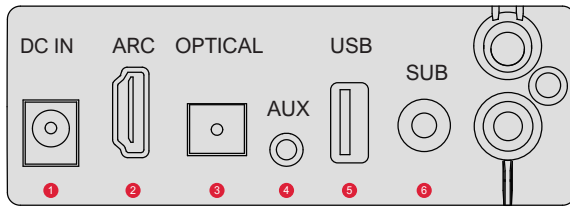

- 1 ENTRADA CC
- 2 HDMI ARC OUT
- 3 ENTRADA ÓPTICA
- 4 AUX IN
- 5 Puerto USB:

Soporta archivos MP3 con 64GB de memoria máxima.

- 6 SUB OUT:

Conectar al subwoofer activo (No incluido).

ES

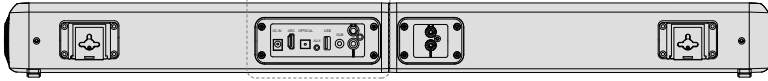

## 5 CONECTAR A TV MEDIANTE ARCO

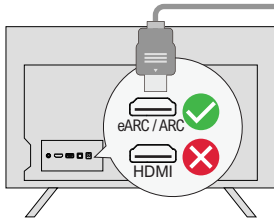

### Paso 1:

Conecte un extremo del cable HDMI al puerto eARC / ARC de la parte posterior de su televisor.

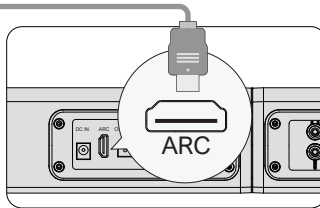

### Paso 2:

A continuación, conecte el otro extremo al puerto ARC de la barra de sonido.

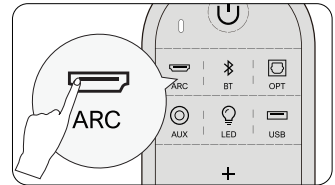

### Paso 3:

Pulse el botón "ARC" del mando a distancia para seleccionar la entrada "ARC".

**Si no hay sonido: intente ajustar la salida de audio del televisor a PCM:**

Ajustes TV > Inicio > Ajustes > Sonido > Salida de audio digital > PCM

**Nota: Active la función "CEC" en su televisor.**

Cuando ARC está conectado, el mando a distancia de su TV puede controlar la barra de sonido y la TV simultáneamente:

- 1 Encender/Apagar
- 2 Ajustar el volumen

## 6 CONECTAR AL TELEVISOR POR VÍA ÓPTICA / AUX

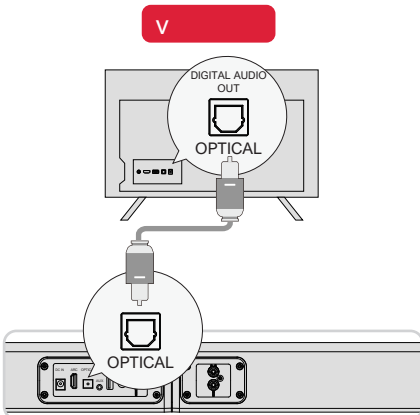

### OPCIÓN 1 : ÓPTICO

- 1 Asegúrese de que el puerto del televisor es OPTICAL OUT, conecte ambos lados del cable a OPTICAL, tanto para el televisor como para la barra de sonido.
- 2 Asegúrese de que el conector óptico está insertado correctamente como se muestra en la imagen. No inserte la clavija al revés y rompa el cable óptico.

**Nota:** Si se reproduce audio por los altavoces internos del televisor, silencio o minimice el volumen del televisor.

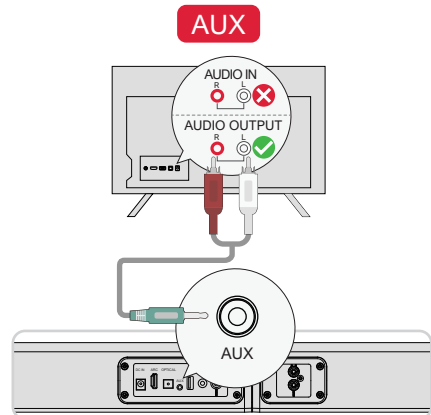

### OPCIÓN 2: AUX

- 1 Conecta el cable de audio de 3,5 mm a RCA al puerto RCA AUDIO OUTPUT de tu TV.
- 2 Asegúrese de que el color de los extremos de los cables coincide con el color de los puertos de TV.

**Nota:** Recuerde desconectar el cable AUX de la TV y del Soundbar cuando quiera cambiar a otro modo.

**En Modo Óptico: Si no hay sonido, pruebe a ajustar la salida de audio del TV a PCM:**  
Ajustes TV > Inicio > Ajustes > Sonido > Salida Audio Digital > PCM



## 7 CONECTAR A BLUETOOTH®

1 Pulse el botón "⏻" en la barra de sonido o pulse el botón "⌘" en el mando a distancia para entrar en el modo de emparejamiento Bluetooth.

2 Vaya a la configuración Bluetooth de su teléfono, busque y seleccione "Apollo S40" para conectar la barra de sonido.

**Nota:** Si ya está en el modo Bluetooth y conectado, mantenga pulsado el botón "⌘" durante 3 segundos para desconectar el dispositivo actual y elija conectarse a un nuevo dispositivo manualmente en su teléfono móvil / PC / TV.

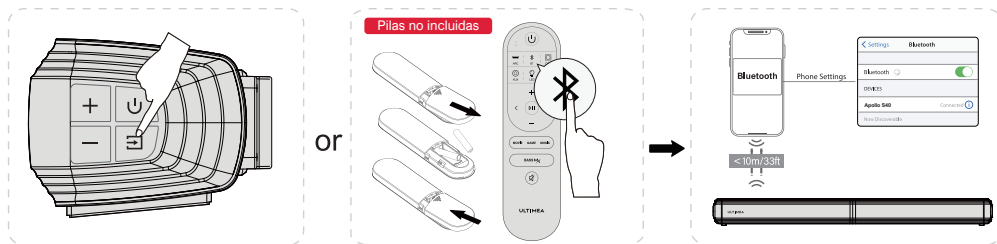

ES

## 8 OPCIONES DE COLOCACIÓN

### Independiente y de pie sobre la base

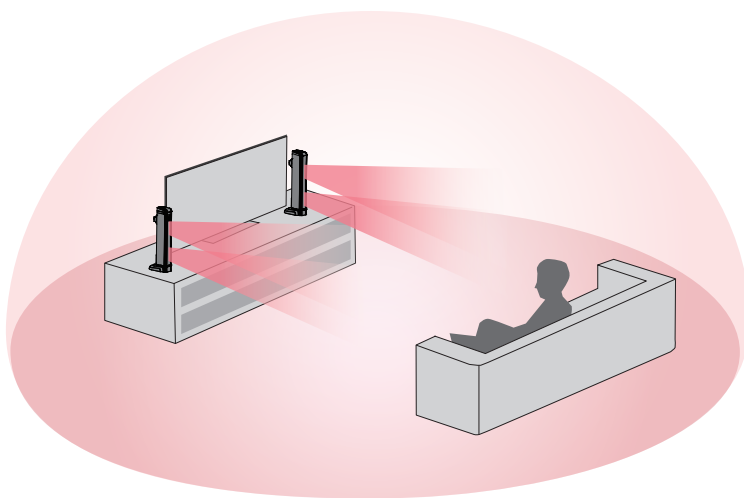

### Colocación horizontal

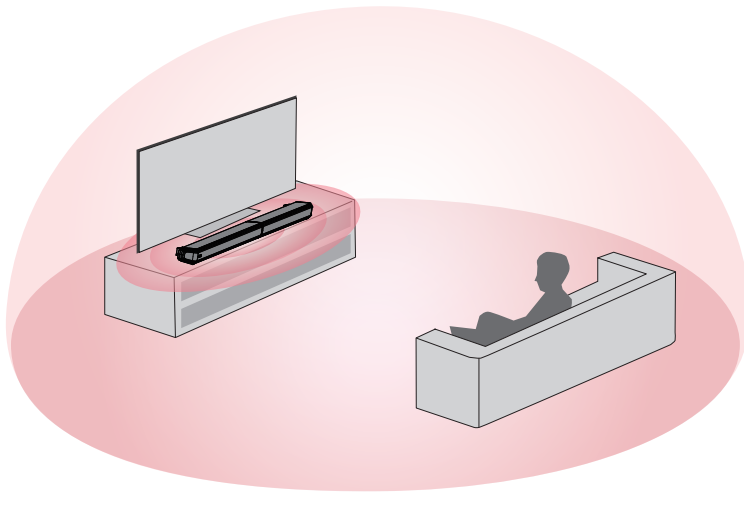

**Nota:** La barra de sonido debe colocarse a la altura de los oídos o cerca de ellos.

## 9 INSTALACIÓN MURAL

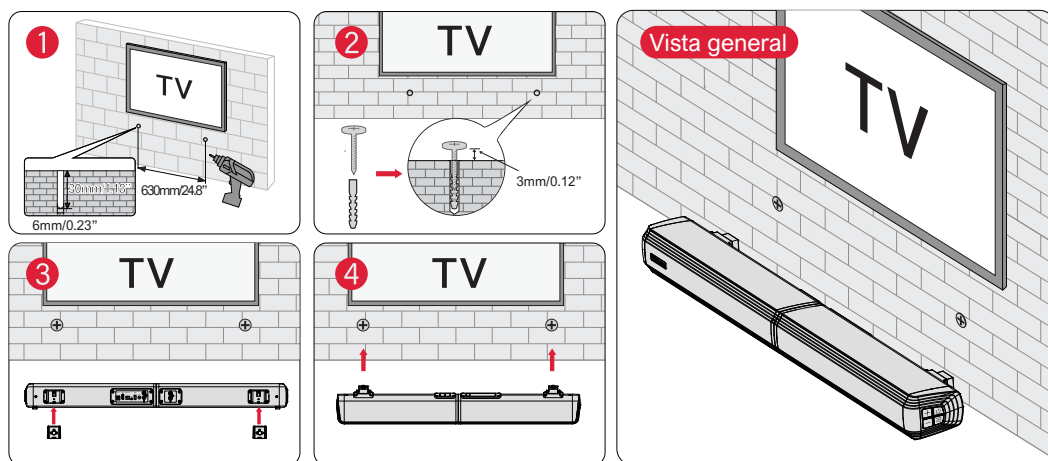

## 10 ESPECIFICACIONES

Número de modelo	U3300
Fuente de alimentación	AC 100-240V, ~50/60Hz
Controladores de la barra de sonido	2.25" x 4 (barra de sonido)
Respuesta en frecuencia	45Hz - 18kHz
Potencia en espera	<0.5W
Temperatura de funcionamiento	0°C - 45°C/32°F - 113°F
Versión Bluetooth	5.3

Dimensiones y peso	
Barra de sonido	811(W) × 98(D) × 70(H)
Embalaje	436(W) × 270(D) × 156(H)
Peso neto	2.3kg / 5.07lbs
Peso bruto	3.6kg / 7.94lbs

## SAFETY INSTRUCTIONS

### Please read this user manual carefully and save it for future reference.

Do not make unauthorized alterations to the product, doing so may compromise safety, regulatory compliance, system performance, and may void the warranty.

- Avoid dropping.
- Do not disassemble.
- Do not submerge in water
- Avoid extreme temperatures.
- Do not use the device outdoors during thunderstorms.
- Use original or certified cables.
- Do not place dangerous items on top of this device (e.g. liquid filled objects, lit candles).
- Clean with a dry, soft lint-free cloth. Do not use any corrosive cleaner or oil.
- To avoid hearing damage, do not listen for extended periods at high volume.
- Do not expose the batteries to extreme heat sources such as direct sunlight or open flames.
- The ideal operating temperature for this product and its accessories is between 41°F/5°C and 95°F/35°C.
- The adapter should be installed near the device and should be easily accessible.
- Do not use this product in environments of extreme heat or cold. Never expose this device to strong sunshine or wet environments.

## PROPER DISPOSAL INSTRUCTIONS



This mark shown on the product or its packaging, indicates that this product should not be disposed of with other household waste at the end of its working life.

To prevent possible harm to the environment or human health from uncontrolled waste disposal, please separate this from other types of wastes and recycle it responsibly to promote the sustainable reuse of material resources.

### Waste Electrical & Electronic Equipment

Household user should contact either the retailer where they purchased this product, or their local government office, for details of where and how they can take this item for environmentally safe recycling.

Business users should contact their suppliers and check the terms and conditions of the purchase contract. This product should not be mixed with other commercial wastes for disposal.

## FCC REGULATORY COMPLIANCE

Any changes or modifications not expressly approved by the party responsible for compliance could void the user's authority to operate the equipment.

This device complies with Part 15 of the FCC Rules.

Operation is subject to the following two conditions:

- (1) This device may not cause harmful interference.
- (2) This device must accept any interference received, including interference that may cause undesired operation.

NOTE: This equipment has been tested and found to comply with the limits for a Class B digital device, pursuant to part 15 of the FCC Rules. These limits are designed to provide reasonable protection against harmful interference in a residential installation. This equipment generates, uses, and can radiate radio frequency energy, and if not installed and used in accordance with the instructions, may cause harmful interference to radio communications.

However, there is no guarantee that interference will not occur in a particular installation. If this equipment does cause harmful interference to radio or television reception, which can be determined by turning the equipment off and on, the user is encouraged to try to correct the interference by one or more of the following measures:

- Reorient or relocate the receiving antenna.
- Increase the separation between the equipment and the receiver.
- Connect the equipment to an outlet on a circuit different from that to which the receiver is connected.
- Consult the dealer or an experienced radio / TV technician for help.

This equipment complies with FCC radiation exposure limits set forth for an uncontrolled environment. This equipment should be installed and operated with a minimum distance of 20cm between the radiator & your body. This transmitter must not be co-located or operating in conjunction with any other antenna or transmitter.

## ISED WARNINGS

This device contains licence-exempt transmitter (s) / receiver (s) that comply with Innovation, Science and Economic Development Canada's licence-exempt RSS (s). Operation is subject to the following two conditions:

- (1) This device may not cause interference.
- (2) This device must accept any interference, including interference that may cause undesired operation of the device.

L'émetteur/récepteur exempt de licence contenu dans le présent appareil est conforme aux CNR d'Innovation, Sciences et Développement économique Canada applicables aux appareils radio exempts de licence. L'exploitation est autorisée aux deux conditions suivantes:

- (1) L'appareil ne doit pas produire de brouillage;
- (2) L'appareil doit accepter tout brouillage radioélectrique subi, même si le brouillage est susceptible d'en compromettre le fonctionnement.

The device meets the exemption from the routine evaluation limits in section 2.5 of RSS 102 and compliance with RSS-102 RF exposure, users can obtain Canadian information on RF exposure and compliance.

Le dispositif rencontre l'exemption des limites courantes d'évaluation dans la section 2.5 de RSS 102 et la conformité à l'exposition de RSS-102 rf, utilisateurs peut obtenir l'information canadienne sur l'exposition et la conformité de rf.

This transmitter must not be co-located or operating in conjunction with any other antenna or transmitter. This equipment should be installed and operated with a minimum distance of 20 centimeters between the radiator and your body.

Cet émetteur ne doit pas être Co-placé ou ne fonctionnant en même temps qu'aucune autre antenne ou émetteur. Cet équipement devrait être installé et actionné avec une distance minimum de 20 centimètres entre le radiateur et votre corps.

## Declaration of Conformity

We (Manufacturer is responsible for this declaration)  
Ultimea Technology (Shenzhen) Limited  
(Company name)

20th Floor, Building 4, Tianan Cloud Park, Bantian St.,  
Longgang District Shenzhen, China 518000  
(Company address)

Declare under our sole responsibility that the product  
Trade Mark: ULTIMEA

Product Name: Apollo S40 2.2 Channel Detachable  
Soundbar

Model No.: U3300

To which this declaration relates is in conformity with  
the essential requirement set out in the Council Directive  
on the Approximation of the laws of the Member States  
relating to RED Directive (2014/53/EU) & RoHS (2011/  
65/EU) product is responsible to affix CE marking, the  
following standards were applied:

EN 55032:2015/A1:2020  
EN 55035:2017/A11:2020  
EN IEC 61000-3-2:2019/A1:2021  
EN 61000-3-3:2013/A2:2021  
ETSI EN 301 489-1 V2.2.3 (2019-11)  
ETSI EN 301 489-17 V3.2.4 (2020-09)  
ETSI EN 300 328 V2.2.2 (2019-07)  
EN 50663: 2017  
EN IEC 62368-1:2020+A11:2020  
IEC 62321-3-1:2013  
IEC 62321-4:2013+A1:2017  
IEC 62321-5:2013  
IEC 62321-6:2015  
IEC 62321-7-1:2015  
IEC 62321-7-2:2017  
IEC 62321-8:2017

Full Name: Yoyo.Yu

Position: Approbation Manager

Signature: 

Place/Date: Shenzhen, China / Nov. 8-2023

## Trade Marks:



The Bluetooth® word mark and logos are registered trademarks owned by Bluetooth SIG, Inc. and any use of such marks by Soundlab Technology Co.,Ltd. is under license. Other trademarks and trade names are those of their respective owners.



The Adopted Trademarks HDMI, HDMI High-Definition Multimedia Interface, HDMI trade dress and the HDMI Logos are trademarks or registered trademarks of HDMI Licensing Administrator, Inc. in the United States and other.

# ULTIMEA

Apollo S40 2.2 Channel Detachable Soundbar  
Model No.: U3300

 Ultimea GmbH  
Buchenring 57, 22359 Hamburg, Germany

 UK CROSSBORDER LIMITED  
7 Bell Yard London WC2A 2JR, UK United Kingdom

Made in China

Manufacturer: Ultimea Technology (Shenzhen) Limited  
Address: 20th Floor, Building 4, Tianan Cloud Park, Bantian St.,  
Longgang District, Shenzhen, China 518000

If you need our support, kindly reach out to our  
service team. We are always glad to help.

+1 888-598-8875 (US)  
Mon-Fri 9am-5pm (PST)  
+49 89-628-25828 (EU)  
Mon-Fri 9am-5pm (CET)

 support@ultimea.com

 support.ultimea.com



@ultimea\_official