

ULTIMEA



Ultimea Skywave

X100

Quick Start Guide



Latest Manual

9.1.6CH

10" SUB



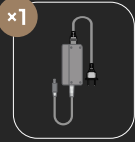
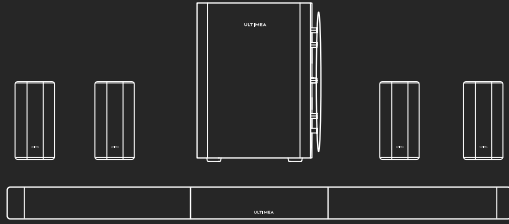

Soundbar Power Adapter(3m / 118")



HDMI Cable (1.5m / 59")

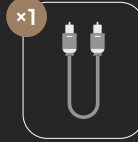

Digital Optical Cable(1.5m / 59")

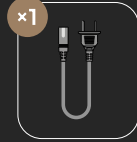

Subwoofer Power Cord(2m / 78")



Surround Power Adapter(3m / 118")



Remote Control

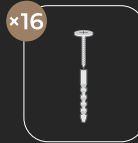

Bracket Screw

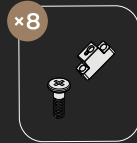

Wall Anchor & Bracket

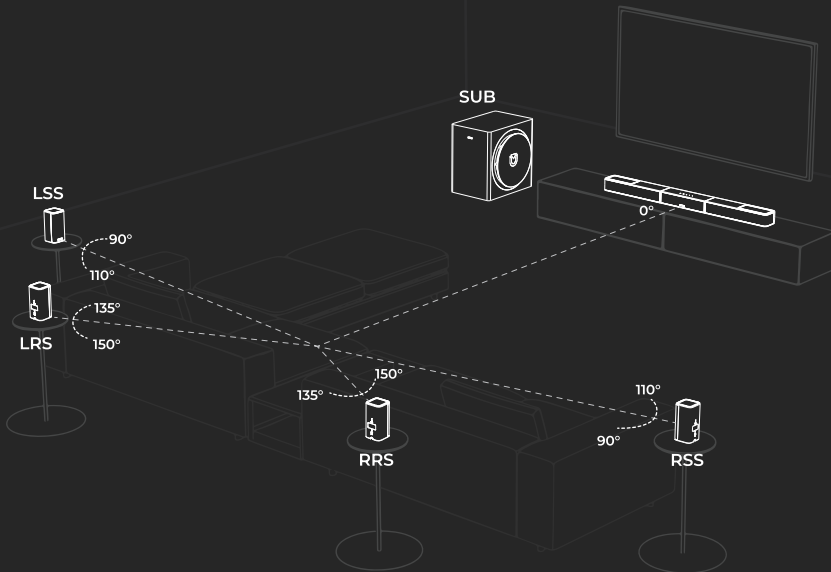



1

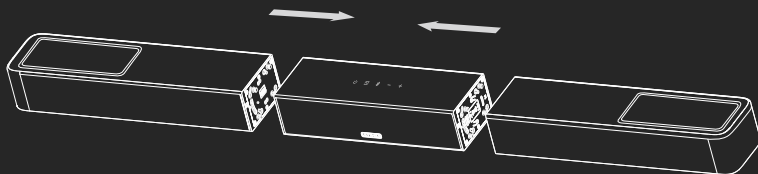

2

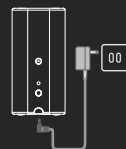
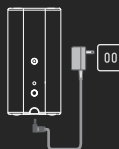
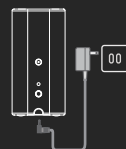
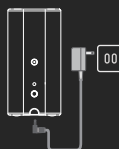
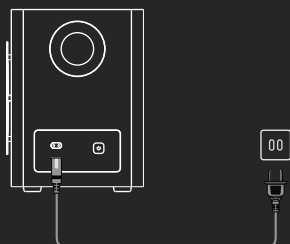
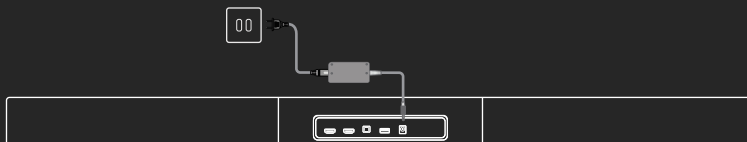
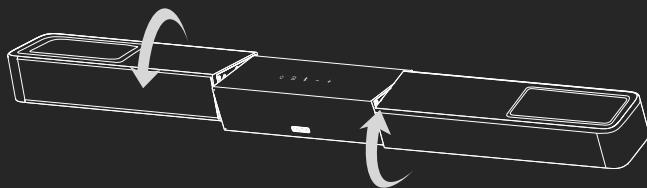



- 1 Bluetooth / 藍牙 / 藍牙 / ブルートゥース / 블루투스 / uqns / بلوتوث
- 2 Input Source Switching / Eingangsquellenumschaltung / Commutation de la source d'entrée / Cambio de fuente de entrada / Commutazione della sorgente di ingresso / Comutação da fonte de entrada / Omschakelen van invoerbron / Przełączanie źródła wejścia / Växling av ingångskälla / Giriş Kaynağı Değiştirme / 入カソース切替 / 輸入源切換 / 輸入來源切換 / 입력 소스 전환 / Peralihan Sumber Input / msaau / تعديل مصدر الإحالة
- 3 Power / Strom / Alimentation / Potencia / Alimentazione / Alimentação / Daya / 電源 / 전원 / wānyuan / الطاقة
- 4 Volume and Playback Control / Lautstärke- und Wiedergabesteuerung / Contrôle du volume et de la lecture / Control de volumen y reproducción / Controllo del volume e della riproduzione / Controle de volume e reprodução / Volumeregeling en afspeelbediening / Regulacja głośności i odtwarzania / Volym- och uppspelningskontroll / Ses ve Oynatma Kontrolü / 音量および再生コントロール / 音量和播放控制 / 音量與播放控制 / 볼륨 및 재생 제어 / Kontrol Volume dan Pemutaran / mshayy / التحكم في مستوى الصوت والتشغيل
- 5 Bass Adjustment / Bassanpassung / Réglage des basses / Ajuste de graves / Regolazione dei bassi / Ajuste de graves / Basregeling / Regulacja basów / Basjustering / Bas Ayarı / 低音調整 / 低音調整 / 低音調整 / 베이스 조절 / Penyesuaian Bass / mshayy / ضبط الجهير
- 6 EQ Presets / EQ-Voreinstellungen / Préréglages EQ / Preajustes de EQ / Preset EQ / Predefinições de EQ / EQ-voorinstellingen / Presety EQ / EQ-förinställningar / EQ On Ayarları / EQ/리셋 / EQ 预设 / EQ 预设 / EQ 프리셋 / Preset EQ / wshayy / الإعدادات المسبقة لمعادل الصوت
- 7 Xupmix On/Off / Xupmix Ein/Aus / Xupmix Activé/Désactivé / Xupmix Activado/Desactivado / Xupmix Attivo/Disattivo / Xupmix Ligado/Desligado / Xupmix Aan/Uit / Xupmix Wł./Wył. / Xupmix På/Av / Xupmix Açık/Kapalı / Xupmix オン/オフ / Xupmix 开关 / Xupmix 開關 / Xupmix 켜기/끄기 / Xupmix Aktif/Nonaktif / Xupmix iDa/Da / Xupmix تشغيل/إيقاف
- 8 Up-firing Speaker Volume / Nach oben abstrahlender Lautsprecherpegel / Volume du haut-parleur à projection vers le haut / Volumen del altavoz de proyección superior / Volume dell'altoparlante up-firing / Volume do alto-falante up-firing / Volume van de omhoog gerichte luidspreker / Głośność głośnika skierowanego do góry / Volym för uppåtriktad högtalare / Yukarı Ateşlemeli Hoparlör Ses Seviyesi / アップファイアリングスピーカー音量 / 天空声扬声器音量 / 向上發聲揚聲器音量 / 업파이어링 스피커 볼륨 / Volume Speaker Menghadap ke Atas / sshayy / مستوى صوت مكبر الصوت الموجه للأعلى
- 9 Surround Volume Level / Surround-Lautstärkepegel / Niveau de volume surround / Nivel de volumen surround / Livello volume surround / Nivel de volume surround / Surround-volumeniveau / Poziom głośności surround / Surroundvolymnivå / Surround Ses Seviyesi / サラウンド音量レベル / 环绕音量级别 / 環繞音量級別 / 서라운드 볼륨 레벨 / Tingkat Volume Surround / sshayy / مستوى صوت المحيط
- 10 Mute / Stumm / Muet / Silencio / Muto / Mudo / Dempen / Wycisz / Ljud av / Sessiz / 뮤트 / 静音 / 静音 / 음스거 / Senyap / mshayy / كم الصوت

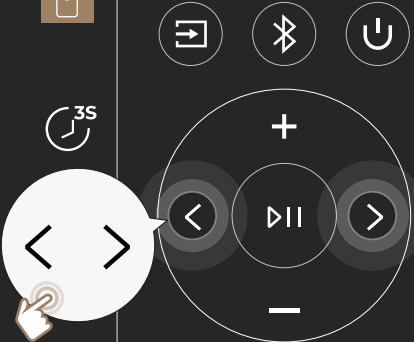

Toggle backlight. / Hintergrundbeleuchtung ein- oder ausschalten. / Activer ou désactiver le rétroéclairage. / Activar o desactivar la luz de fondo. / Attivare o disattivare la retroilluminazione. / Ativar ou desativar a luz de fundo. / Achtergrondverlichting in- of uitschakelen. / Włączyć lub wyłączyć podświetlenie. / Slå på eller av bakgrundsbelysningen. / Arka ışığı aç veya kapat. / バックライトをオンまたはオフにする。 / 开启或关闭背光。 / 開啟或關閉背光。 / 백라이트를 켜거나 끄기. / Menyalakan atau mematikan lampu latar. / mshayy / تشغيل أو إيقاف الإضاءة الخلفية.

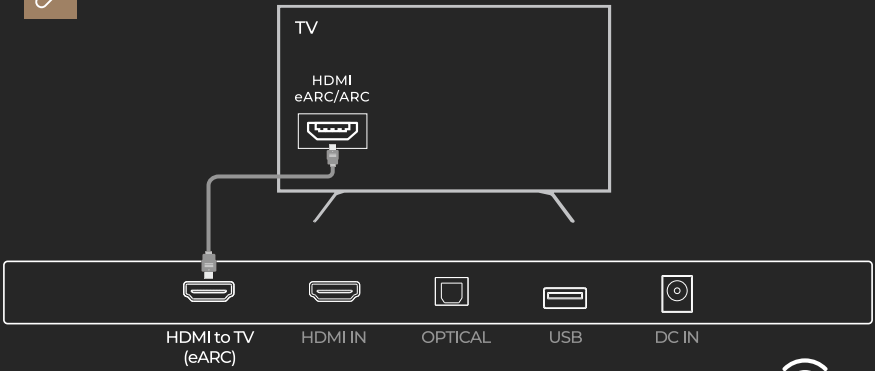

eARC HDIN OPT USB BT

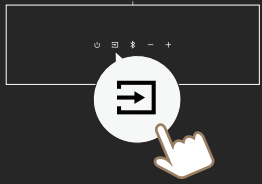

OR

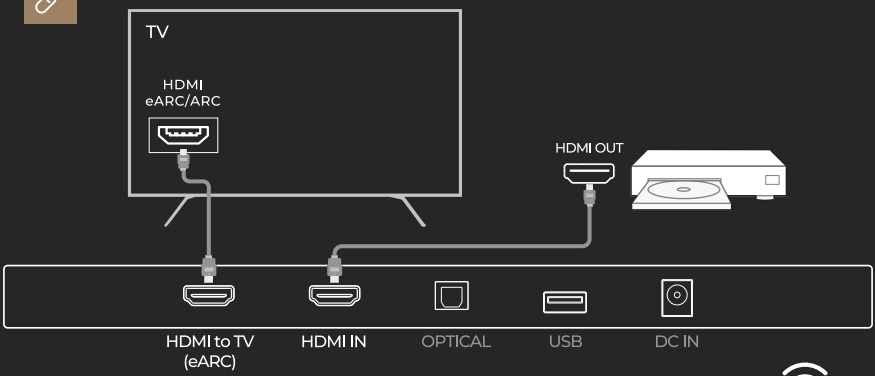
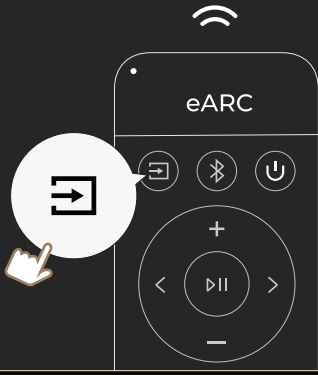

eARC HDIN OPT USB BT

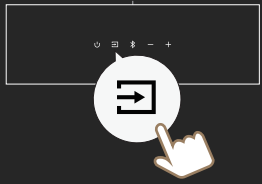

OR

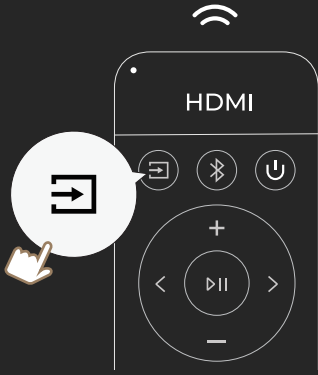

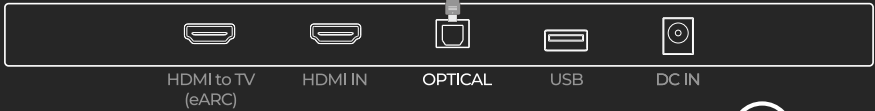
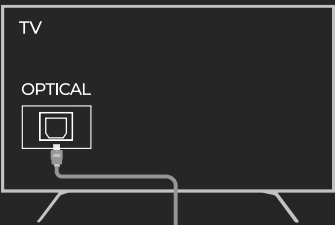

OR

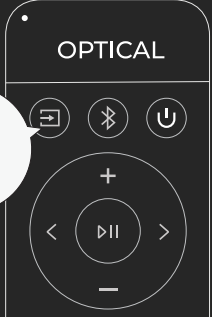

1



OR

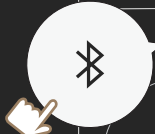

2

<10m/33ft



Phone Settings

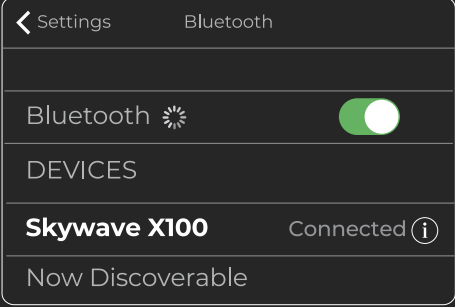

ULTIMEA

Product Name: Soundbar
Model No.: U622B

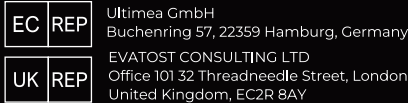

@Ultimea Inc. All rights reserved,
registered in the United States and other countries.
801 S Dupont Ave, STE G, Ontario, CA, 91761
FCC ID: 2A900-U622AS

Made in China
Manufacturer: Ultimea Technology (Shenzhen) Limited
Address: 20th Floor, Building 4, Tianan Cloud Park, Bantian St.,
Longgang District, Shenzhen, China 518000

Manufacturer Contact Information:

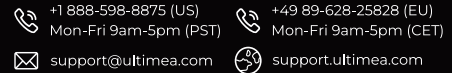

If you need our support, kindly reach out to our service team.
We are always glad to help.



Warranty Extension Plan

Trade Marks:



Dolby, Dolby Atmos, and the double-D symbol are registered trademarks of Dolby Laboratories Licensing Corporation. Manufactured under license from Dolby Laboratories. Confidential unpublished works. Copyright © 2012–2024 Dolby Laboratories. All rights reserved.



Manufactured under license from DTS, Inc. and/or its affiliates. For patents, see <https://xperi.com/dts-patents/>. DTS, the DTS logo, DTS:X, the DTS:X logo, VirtualX, and the DTS VirtualX logo are trademarks or registered trademarks of DTS, Inc. and/or its affiliates in the U.S. and/or other countries. © DTS, Inc. and/or its affiliates. All rights reserved.



The Bluetooth® word mark and logos are registered trademarks owned by Bluetooth SIG, Inc. The Auracast™ word mark and logos are trademarks owned by the Bluetooth SIG. Any use of such marks by Ultimea Technology (Shenzhen) Limited is under license. Other trademarks and trade names are those of their respective owners.



The terms HDMI, HDMI High-Definition Multimedia Interface, HDMI trade dress and the HDMI Logos are trademarks or registered trademarks of HDMI Licensing Administrator, Inc.



THX and the THX Logo are the property of THX Ltd., registered in the U.S. and other countries. Tuned by THX is a trademark belonging to THX Ltd.

EU DECLARATION OF CONFORMITY

We (Manufacturer is responsible for this declaration)
20th Floor, Building 4, Tianan Cloud Park, Bantian St.,
Declare under our sole responsibility that the product
Trade Mark: ULTIMEA
Product Name: Soundbar
Model No.: U622B

Ultimea Technology (Shenzhen) Limited
Longgang District Shenzhen, China 518000

The product to which this declaration relates is in conformity with the essential requirements set out in the Council Directive on the Approximation of the laws of the Member States relating to the Radio Equipment Directive (2014/53/EU), the Restriction of Hazardous Substances Directive (2011/65/EU), the Electromagnetic Compatibility Directive (2014/30/EU), and the Low Voltage Directive (2014/35/EU). The product is responsible for affixing the CE marking, and the following standards were applied:

EN 55032:2015/A1:2020
EN 55035:2017/A1:2020
EN IEC 61000-3-2:2019/A1:2021
EN 61000-3-3:2013/A2:2021
ETSI EN 301 489-1 V2.2.3 (2019-11)
ETSI EN 301 489-17 V3.2.4 (2020-09)
ETSI EN 300 328 V2.2.2 (2019-07)
EN 50663: 2017
EN IEC 62368-1:2020+A11:2020

IEC 62321-3-1:2013
IEC 62321-4:2013+A1:2017
IEC 62321-5:2013
IEC 62321-6:2015
IEC 62321-7-1:2015
IEC 62321-7-2:2017
IEC 62321-8:2017

Full Name: Yoyo.Yu
Position: Approval Manager
Signature:
Place/Date: Shenzhen, China / March 10, 2026

PROPER DISPOSAL INSTRUCTIONS



This mark shown on the product or its packaging, indicates that this product should not be disposed of with other household waste at the end of its working life. To prevent possible harm to the environment or human health from uncontrolled waste disposal, please separate this from other types of wastes and recycle it responsibly to promote the sustainable reuse of material resources.

WASTE ELECTRICAL & ELECTRONIC EQUIPMENT

Household user should contact either the retailer where they purchased this product, or their local government office, for details of where and how they can take this item for environmentally safe recycling. Business users should contact their suppliers and check the terms and conditions of the purchase contract. This product should not be mixed with other commercial wastes for disposal.

WIRELESS FREQUENCY RANGE AND WIRELESS OUTPUT POWER:

Frequency: 2.402GHz-2.48GHz,5.8GHz
Soundbar BT Max.transmit power: 13.03dBm
Soundbar wireless Max.transmit power: 11.62dBm
Surround wireless Max.transmit power: 11.43dBm

FCC REGULATORY COMPLIANCE

Any changes or modifications not expressly approved by the party responsible for compliance could void the user's authority to operate the equipment.

This device complies with Part 15 of the FCC Rules.

Operation is subject to the following two conditions:

(1) This device may not cause harmful interference.

(2) This device must accept any interference received, including interference that may cause undesired operation.

NOTE: This equipment has been tested and found to comply with the limits for a Class B digital device, pursuant to part 15 of the FCC Rules. These limits are designed to provide reasonable protection against harmful interference in a residential installation. This equipment generates, uses, and can radiate radio frequency energy, and if not installed and used in accordance with the instructions, may cause harmful interference to radio communications.

However, there is no guarantee that interference will not occur in a particular installation. If this equipment does cause harmful interference to radio or television reception, which can be determined by turning the equipment off and on, the user is encouraged to try to correct the interference by one or more of the following measures:

- Reorient or relocate the receiving antenna.

- Increase the separation between the equipment and the receiver.

- Connect the equipment to an outlet on a circuit different from that to which the receiver is connected.

- Consult the dealer or an experienced radio / TV technician for help.

This equipment complies with FCC radiation exposure limits set forth for an uncontrolled environment. This equipment should be installed and operated with a minimum distance of 20cm between the radiator & your body. This transmitter must not be co-located or operating in conjunction with any other antenna or transmitter.

CE WARNINGS

(1) Do not install this equipment in a confined or building-in space such as a book case or similar unit, and remain a well ventilation conditions. The ventilation should not be impeded by covering the ventilation openings with items such as newspaper, table-cloths, curtains etc.

(2) WARNING: To reduce the risk of fire or electric shock, do not expose this apparatus to rain or moisture. The apparatus shall not be exposed to dripping or splashing and that objects filled with liquids, such as vases, shall not be placed on apparatus.

(3) WARNING: The adapter plug is used as disconnect device, the disconnect device shall remain readily operable.

(4) Frequency: 2.402GHz-2.48GHz

(5) The Max. transmit power: 10 dBm

▲ WARNING: This product can expose you to chemicals including lead, which is known to the State of California to cause cancer and birth defects or other reproductive harm. For more information, go to www.P65Warnings.ca.gov.

Safety Instructions

(1) Please read and keep these instructions. Follow all warnings and instructions.

(2) Do not use the device near water, in damp environments, or in the rain. Avoid liquid spills and do not place objects containing liquids (such as vases) on the device.

(3) Clean only with a dry cloth. Do not use liquid cleaners.

(4) Do not block ventilation openings or install the device in a confined space. Ensure proper ventilation according to the manufacturer's instructions.

(5) Do not install the device near heat sources such as radiators, stoves, or amplifiers, and do not cover the ventilation openings with items like newspapers or curtains.

(6) Use only attachments, stands, or accessories specified by the manufacturer. Be cautious when moving the device on wheels to prevent tipping.

(7) Protect the power cord from being walked on, pinched, or bent, especially at plugs, convenience receptacles, and the point where they exit from the device.

(8) Do not modify the polarized or grounding-type plug. If the plug does not fit into your outlet, consult an electrician to replace the outlet.

(9) Unplug the device during lightning storms or when unused for long periods. To completely disconnect the device, unplug it from the power outlet and ensure the plug is easily accessible.

(10) Do not place any open flame sources, such as lit candles, on the device.

(11) Do not attempt to open the device. There is a risk of dangerous high voltage. No user-serviceable parts inside. All servicing must be carried out by qualified personnel.

(12) The installation height of the device must not exceed 2 meters.

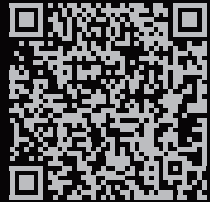

More safety info via QR code
Weitere Sicherheitshinweise per QR-Code
QRコードで安全情報を見る



App



Download Ultimea App

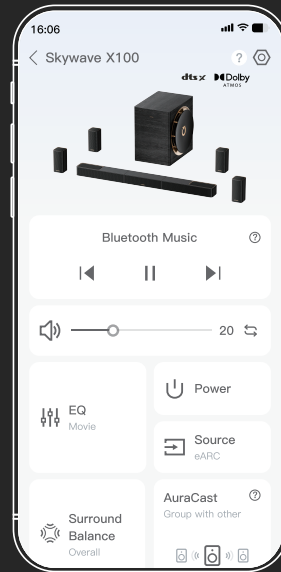
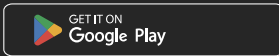

EQ Mode



Up-Firing Level

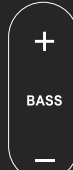

BASS



Xupmix



Surround Level



Restore factory settings./
 Werkseinstellungen wiederherstellen./
 Restaurer les paramètres d'usine./
 Restaurar los ajustes de fábrica./
 Ripristina le impostazioni di fabbrica./
 Restaurar as configurações de fábrica./
 Fabriksinstellingen herstellen./
 Przywróć ustawienia fabryczne./
 Återställ fabriksinställningarna./
 Fabrika ayarlarını geri yükle./
 工場出荷設定をリセット。/ 恢复出厂设置。/ 恢復出廠設定。/ 공장 초기화。/
 Kembalikan ke setelan pabrik. / สิ้นค่าเป็นค่าจากโรงงาน / استعادة إعدادات المصنع.



1

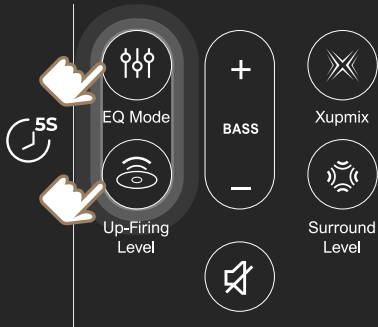

2

eARC HDIN OPT USB BT



- EN** The soundbar and remote are factory paired. If pairing is lost, switch the soundbar to BT mode and hold "Source" for 10 seconds, then hold "EQ Mode" and "Up-Firing" on the remote for 5 seconds to re-pair.
- DE** Soundbar und Fernbedienung sind ab Werk gekoppelt. Wenn die Kopplung verloren geht, schalten Sie die Soundbar in den BT-Modus und halten Sie „Source“ 10 Sekunden gedrückt, halten Sie anschließend „EQ Mode“ und „Up-Firing“ auf der Fernbedienung 5 Sekunden gedrückt, um erneut zu koppeln.
- FR** La barre de son et la télécommande sont appariées en usine. Si l'appairage est perdu, passez la barre de son en mode BT et maintenez « Source » pendant 10 secondes, puis maintenez « EQ Mode » et « Up-Firing » sur la télécommande pendant 5 secondes pour réappairer.
- ES** La barra de sonido y el control remoto vienen emparejados de fábrica. Si se pierde el emparejamiento, cambie la barra de sonido al modo BT y mantenga pulsado "Source" durante 10 segundos, luego mantenga pulsados "EQ Mode" y "Up-Firing" en el control remoto durante 5 segundos para volver a emparejar.
- IT** La soundbar e il telecomando sono accoppiati in fabbrica. Se l'accoppiamento viene perso, passa la soundbar alla modalità BT e tieni premuto "Source" per 10 secondi, quindi tieni premuti "EQ Mode" e "Up-Firing" sul telecomando per 5 secondi per riassociare.
- PT** A soundbar e o controle remoto vêm emparelhados de fábrica. Se o emparelhamento for perdido, coloque a soundbar no modo BT e mantenha pressionado "Source" por 10 segundos, depois mantenha pressionados "EQ Mode" e "Up-Firing" no controle remoto por 5 segundos para emparelhar novamente.
- NL** De soundbar en afstandsbediening zijn in de fabriek gekoppeld. Als de koppeling verloren gaat, schakel de soundbar naar de BT-modus en houd "Source" 10 seconden ingedrukt, houd vervolgens "EQ Mode" en "Up-Firing" op de afstandsbediening 5 seconden ingedrukt om opnieuw te koppelen.
- PL** Soundbar i pilot są sparowane fabrycznie. Jeśli sparowanie zostanie utracone, przełącz soundbar w tryb BT i przytrzymaj „Source” przez 10 sekund, następnie przytrzymaj jednocześnie „EQ Mode” i „Up-Firing” na pilocie przez 5 sekund, aby ponownie sparować.
- SV** Soundbaren och fjärrkontrollen är fabriksparade. Om parningen förloras, växla soundbaren till BT-läge och håll "Source" intryckt i 10 sekunder, håll sedan "EQ Mode" och "Up-Firing" på fjärrkontrollen intryckta i 5 sekunder för att para om.
- TR** Soundbar ve uzaktan kumanda fabrikada eşleştirilmiştir. Eşleştirme kaybolursa, soundbar'ı BT moduna alın ve "Source" tuşuna 10 saniye basılı tutun, ardından uzaktan kumandada "EQ Mode" ve "Up-Firing" tuşlarına aynı anda 5 saniye basılı tutarak yeniden eşleştirin.
- JA** サウンドバーとリモコンは工場出荷時にペアリングされています。ペアリングが解除された場合は、サウンドバーをBTモードに切り替えて「Source」を10秒間長押しし、その後リモコンの「EQ Mode」と「Up-Firing」を同時に5秒間長押しして再ペアリングしてください。
- CN** 音箱与遥控器出厂已完成配对,如连接断开,请将音箱切换至蓝牙模式并长按「Source」键10秒,再同时长按遥控器上的「EQ Mode」和「Up-Firing」键5秒以重新配对。
- TC** 音響與遙控器出廠時已完成配對,如配對中斷,請將音響切換至藍牙模式並長按「Source」鍵10秒,再同時長按遙控器上的「EQ Mode」與「Up-Firing」鍵5秒以重新配對。
- KO** 사운드바와 리모컨은 출고 시 페어링되어 있습니다. 페어링이 해제되면 사운드바를 BT 모드로 전환한 후 "Source" 버튼을 10초간 길게 누르고, 이어서 리모컨의 "EQ Mode"와 "Up-Firing" 버튼을 동시에 5초간 길게 눌러 다시 페어링하세요.
- ID** Soundbar dan remote telah dipasangkan dari pabrik. Jika pemasangan terputus, alihkan soundbar ke mode BT dan tahan "Source" selama 10 detik, lalu tahan "EQ Mode" dan "Up-Firing" pada remote selama 5 detik untuk memasangkan kembali.
- TH** ซาวด์บาร์และรีโมตถูกจับคู่จากโรงงาน หากการจับคู่หยุดหาย ให้เปลี่ยนซาวด์บาร์เป็นโหมด BT และกดค้าง "Source" เป็นเวลา 10 วินาที จากนั้นกดค้าง "EQ Mode" และ "Up-Firing" บนรีโมตพร้อมกัน 5 วินาทีเพื่อจับคู่ใหม่

يتم إقران السماعة الشريطية وجهاز التحكم عن بُعد من المصنع. في حال فقدان الاقتران، حوّل السبماعة إلى وضع BT واضغط مطوّلاً على "Source" لمدة 10 ثوانٍ، ثم اضغط مطوّلاً على "EQ Mode" و "Up-Firing" في جهاز التحكم لمدة 5 ثوانٍ لإعادة الاقتران.

AR

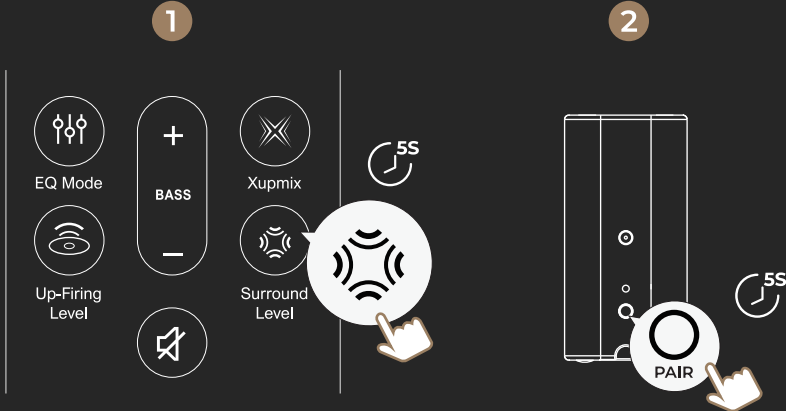

EN The soundbar and surround speakers are factory paired. If disconnected, press and hold the "Surround Level" button on the remote and the "PAIR" button on the surround speaker for about 5 seconds. The indicator stays solid when pairing is complete.

DE Soundbar und Surround-Lautsprecher sind werkseitig gekoppelt. Wenn die Verbindung unterbrochen wird, halten Sie die Taste „Surround Level“ auf der Fernbedienung und die Taste „PAIR“ am Surround-Lautsprecher gleichzeitig etwa 5 Sekunden lang gedrückt. Nach erfolgreicher Kopplung leuchtet die Anzeige dauerhaft.

FR La barre de son et les haut-parleurs surround sont appairés en usine. En cas de déconnexion, maintenez simultanément le bouton « Surround Level » de la télécommande et le bouton « PAIR » du haut-parleur surround pendant environ 5 secondes. Le voyant reste allumé une fois l'appairage terminé.

ES La barra de sonido y los altavoces surround vienen emparejados de fábrica. Si se desconectan, mantenga pulsados simultáneamente el botón "Surround Level" del control remoto y el botón "PAIR" del altavoz surround durante unos 5 segundos. El indicador permanece encendido cuando el emparejamiento se completa.

IT La soundbar e gli altoparlanti surround sono abbinati in fabbrica. In caso di disconnessione, tenere premuti contemporaneamente il pulsante "Surround Level" sul telecomando e il pulsante "PAIR" sull'altoparlante surround per circa 5 secondi. L'indicatore rimane acceso fisso al termine dell'abbinamento.

PT A soundbar e os alto-falantes surround são emparelhados de fábrica. Se a conexão for perdida, pressione e mantenha pressionados simultaneamente o botão "Surround Level" no controle remoto e o botão "PAIR" no alto-falante surround por cerca de 5 segundos. O indicador permanece aceso quando o emparelhamento é concluído.

NL De soundbar en surround-luidsprekers zijn in de fabriek gekoppeld. Als de verbinding wordt verbroken, houd de knop "Surround Level" op de afstandsbediening en de knop "PAIR" op de surround-luidspreker tegelijkertijd ongeveer 5 seconden ingedrukt. Het indicatielampje blijft continu branden wanneer het koppelen is voltooid.

PL Soundbar i głośniki surround są sparowane fabrycznie. W przypadku utraty połączenia naciśnij i przytrzymaj jednocześnie przycisk „Surround Level” na pilocie oraz przycisk „PAIR” na głośniku surround przez około 5 sekund. Po zakończeniu parowania wskaźnik świeci światłem ciągłym.

SV Soundbaren och surroundhögtalarna är fabriksparade. Om anslutningen bryts, håll knappen "Surround Level" på fjärrkontrollen och knappen "PAIR" på surroundhögtalaren intryckta samtidigt i cirka 5 sekunder. Indikatorlampan lyser fast när parningen är klar.

TR Soundbar ve surround hoparlörler fabrikada eşleştirilmiştir. Bağlantı kesilirse, uzaktan kumandadaki "Surround Level" düğmesini ve surround hoparlör üzerindeki "PAIR" düğmesini yaklaşık 5 saniye boyunca aynı anda basılı tutun. Eşleştirme tamamlandıgında gösterge sabit yanar.

JA サウンドバーとサラウンドスピーカーは工場出荷時にペアリングされています。接続が切れた場合は、リモコンの「Surround Level」ボタンとサラウンドスピーカーの「PAIR」ボタンを同時に約5秒間押し続けてください。ペアリングが完了すると、インジケータは点灯したままになります。

CN Soundbar 与环绕扬声器在出厂时已完成配对。如连接断开, 请同时按住遥控器上的“Surround Level”键和环绕扬声器上的“PAIR”键约 5 秒。配对完成后, 指示灯将常亮。

TC Soundbar 與環繞揚聲器在出廠時已完成配對。如連線中斷, 請同時按住遙控器上的「Surround Level」鍵與環繞揚聲器上的「PAIR」鍵約 5 秒。配對完成後, 指示燈將保持常亮。

KO 사운드바와 서라운드 스피커는 출고 시 이미 페어링되어 있습니다. 연결이 끊어진 경우 리모컨의 "Surround Level" 버튼과 서라운드 스피커의 "PAIR" 버튼을 동시에 약 5초간 길게 누르세요. 페어링이 완료되면 표시등이 계속 켜져 있습니다.

ID Soundbar dan speaker surround telah dipasangkan di pabrik. Jika koneksi terputus, tekan dan tahan tombol "Surround Level" pada remote dan tombol "PAIR" pada speaker surround secara bersamaan selama sekitar 5 detik. Indikator akan menyala terus setelah pemasangan selesai.

TH ซาวด์บาร์และลำโพงเซอร์ราวด์ถูกจับคู่จากโรงงาน หากการเชื่อมต่อขาดหาย ให้กดปุ่ม "Surround Level" บนรีโมตควบคู่กับปุ่ม "PAIR" บนลำโพงเซอร์ราวด์ค้างไว้พร้อมกัน 5 วินาที เมื่อจับคู่เสร็จสมบูรณ์ ไฟแสดงสถานะจะติดค้างไว้

AR تم إقران السماعة الشريطية ومكبرات الصوت المحيطة في المصنع. في حال انقطاع الاتصال، اضغط مع الاستمرار على زر "Surround Level" في جهاز التحكم و زر "PAIR" في مكبر الصوت المحيط في الوقت نفسه لمدة 5 ثوان تقريبًا. سيبقى مؤشر الإضاءة ثابتًا عند اكتمال الاقتران.

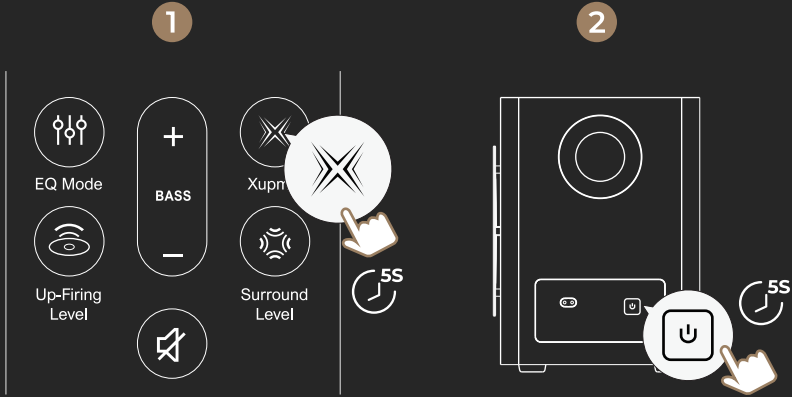

- EN** The soundbar and subwoofer are factory paired. If disconnected, press and hold the “Xupmix” button on the remote and the “ON/Standby” button on the subwoofer for about 5 seconds. The indicator stays solid when pairing is complete.
- DE** Soundbar und Subwoofer sind werkseitig gekoppelt. Wenn die Verbindung unterbrochen wird, halten Sie die Taste „Xupmix“ auf der Fernbedienung und die Taste „ON/Standby“ am Subwoofer gleichzeitig etwa 5 Sekunden lang gedrückt. Nach erfolgreicher Kopplung leuchtet die Anzeige dauerhaft.
- FR** La barre de son et le caisson de basses sont appairés en usine. En cas de déconnexion, maintenez simultanément le bouton « Xupmix » de la télécommande et le bouton « ON/Standby » du caisson pendant environ 5 secondes. Le voyant reste allumé une fois l'appairage terminé.
- ES** La barra de sonido y el subwoofer vienen emparejados de fábrica. Si se desconectan, mantenga pulsados simultáneamente el botón “Xupmix” no control remoto y el botón “ON/Standby” del subwoofer durante unos 5 segundos. El indicador permanece encendido cuando el emparejamiento se completa.
- IT** La soundbar e il subwoofer sono abbinati in fabbrica. In caso di disconnessione, tenere premuti contemporaneamente il pulsante “Xupmix” sul telecomando e il pulsante “ON/Standby” sul subwoofer per circa 5 secondi. L'indicatore rimane acceso fisso al termine dell'abbinamento.
- PT** A soundbar e o subwoofer são emparelhados de fábrica. Se a conexão for perdida, pressione e mantenha pressionados simultaneamente o botão “Xupmix” no controle remoto e o botão “ON/Standby” no subwoofer por cerca de 5 segundos. O indicador permanece aceso quando o emparelhamento é concluído.
- NL** De soundbar en subwoofer zijn in de fabriek gekoppeld. Als de verbinding wordt verbroken, houd de knop “Xupmix” op de afstandsbediening en de knop “ON/Standby” op de subwoofer tegelijkertijd ongeveer 5 seconden ingedrukt. Het indicatielampje blijft continu branden wanneer het koppelen is voltooid.
- PL** Soundbar i subwoofer są sparowane fabrycznie. W przypadku utraty połączenia naciśnij i przytrzymaj jednocześnie przycisk „Xupmix” na pilocie oraz przycisk „ON/Standby” na subwooferze przez około 5 sekund. Po zakończeniu parowania wskaźnik świeci światłem ciągłym.
- SV** Soundbaren och subwoofern är fabriksparade. Om anslutningen bryts, håll knapperna “Xupmix” på fjärrkontrollen och knapperna “ON/Standby” på subwoofern intryckta samtidigt i cirka 5 sekunder. Indikatorlampan lyser fast när parningen är klar.
- TR** Soundbar ve subwoofer fabrikada eşleştirilmiştir. Bağlantı kesilirse, uzaktan kumandadaki “Xupmix” düğmesini ve subwoofer üzerindeki “ON/Standby” düğmesini yaklaşık 5 saniye boyunca aynı anda basılı tutun. Eşleştirme tamamlandığında gösterge sabit yanar.
- JA** サウンドバーとサブウーファーは工場出荷時にペアリングされています。接続が切れた場合は、リモコンの「Xupmix」ボタンとサブウーファーの「ON/Standby」ボタンを同時に約5秒間押し続けてください。ペアリングが完了すると、インジケータは点灯したままになります。
- CN** Soundbar 与低音炮在出厂时已完成配对。如连接断开，请同时按住遥控器上的“Xupmix”键和低音炮上的“ON/Standby”键约5秒。配对完成后，指示灯将常亮。
- TC** Soundbar 與低音炮在出廠時已完成配對。如連線中斷，請同時按住遙控器上的“Xupmix”鍵與低音炮上的「ON/Standby」鍵約5秒。配對完成後，指示燈將保持常亮。
- KO** 사운드바와 서브우퍼는 출고 시 이미 페어링되어 있습니다. 연결이 끊어진 경우 리모컨의 “Xupmix” 버튼과 서브우퍼의 “ON/Standby” 버튼을 동시에 약 5초간 길게 누르세요. 페어링이 완료되면 표시등이 계속 켜져 있습니다.
- ID** Soundbar dan subwoofer telah dipasangkan di pabrik. Jika koneksi terputus, tekan dan tahan tombol “Xupmix” pada remote dan tombol “ON/Standby” pada subwoofer secara bersamaan selama sekitar 5 detik. Indikator akan menyala terus setelah pemasangan selesai.
- TH** ซาวด์บาร์และซับวูฟเฟอร์ถูกจับคู่จากโรงงาน หากการเชื่อมต่อขาดหาย ให้กดปุ่ม “Xupmix” บนรีโมตควบคู่กับปุ่ม “ON/Standby” บนซับวูฟเฟอร์พร้อมกันประมาณ 5 วินาที เมื่อจับคู่เสร็จแล้วไฟแสดงสถานะจะติดค้างไว้

تم إقران السماعة الشريطية ومضخم الصوت في المصنع، في حال انقطاع الاتصال، اضغط مع الاستمرار مع زر “Xupmix” في جهاز التحكم و زر “ON/Standby” في مضخم الصوت في الوقت نفسه لمدة 5 ثوانٍ تقريبًا، سيبقى مؤشر الإضاءة ثابتًا عند اكتمال الاقتران.

