

Ultimea Poseidon

M40

USER MANUAL

User Manual / Bedienungsanleitung / Manuel d'utilisation / Manual de usuario / Manuale utente / Manual do utilizador / Gebruikershandleiding / Instrukcja obsługi / Användarhandbok / Kullanım kılavuzu / 取扱説明書 / 用户手册 / 使用者手冊 / 사용 설명서 / Panduan Pengguna / دليل المستخدم / دليل المستخدم

Model No.: U3120

Product Name: Soundbar

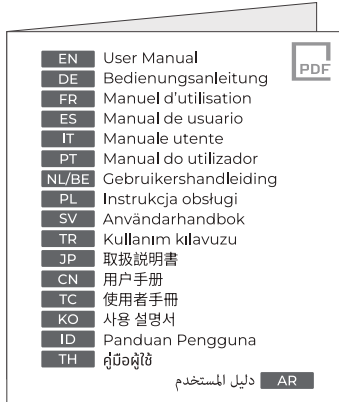
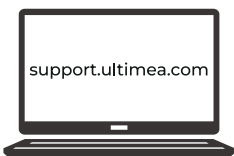
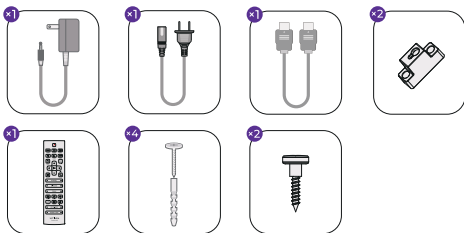
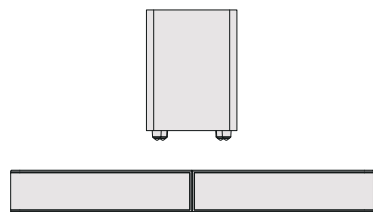

1

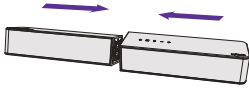

2

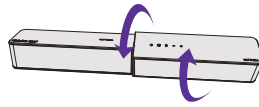

- EN** Align the seams of the two parts and rotate to connect. Do not operate with power on.
DE Richten Sie die Nähte der beiden Teile aus und drehen Sie sie zum Verbinden. Nicht unter Strom betreiben.
FR Alignez les coutures des deux parties et tournez pour connecter. Ne pas utiliser sous tension.
ES Alinee las costuras de las dos partes y gírelas para conectar. No opere con la energía encendida.
IT Allineare le giunzioni delle due parti e ruotare per connettere. Non operare con l'alimentazione accesa.
PT Alinhe as costuras das duas partes e gire para conectar. Não opere com a energia ligada.
NL/BE Lijn de naden van de twee delen uit en draai om te verbinden. Niet bedienen met stroom ingeschakeld.
PL Wyrównaj szwy dwóch części i obróć, aby połączyć. Nie obsługiwać pod napięciem.
SV Justera sömmarna på de två delarna och rotera för att ansluta. Använd inte med strömmen på.
TR İki parçanın dikişlerini hizalayın ve bağlamak için döndürün. Güç açıkken çalıştırmayın.
JP 2つの部品の継ぎ目を揃え、回転させて接続してください。電源が入った状態で操作しないでください。
CN 对齐两个部件的接缝并旋转连接。请勿在通电状态下操作。
TC 對齊兩個部件的接縫並旋轉連接。請勿在通電狀態下操作。
KO 두 부품의 이음을 맞추고 회전하여 연결하십시오. 전원이 켜진 상태에서 조작하지 마십시오.
ID Ratakan sambungan dua komponen dan putar untuk menghubungkannya.
TH จัดแนวรอยต่อของชิ้นส่วนสองชิ้นแล้วเชื่อมต่อ อย่างดีเป็นการระมัดระวังไฟฟ้าเข้า

قم محاذاة اللحامات بين الجزأين وقم بتدويرهما للاتصال. لا تقم بتشغيل أثناء تشغيل الطاقة.

AR

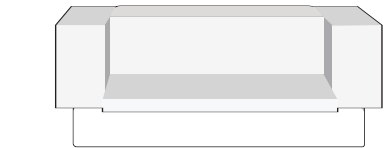
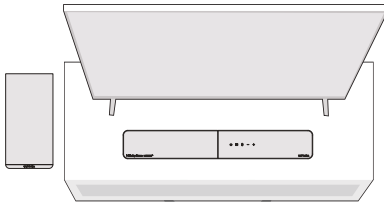

or

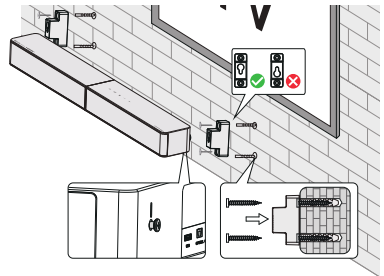
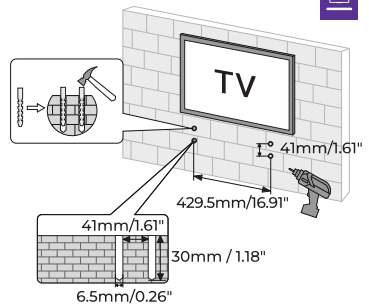

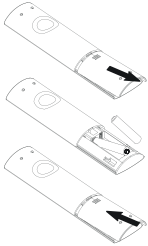
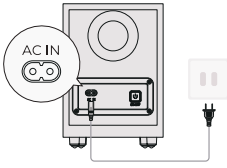
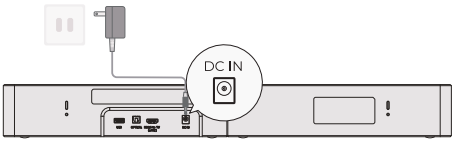

- EN** Batteries Not Included.
 - DE** Batterien nicht enthalten.
 - FR** Piles non incluses.
 - ES** Baterías no incluidas.
 - IT** Batterie non incluse.
 - PT** Baterias não incluídas.
 - NL/BE** Batterijen niet inbegrepen.
 - PL** Baterie nie są dołączone.
 - SV** Batterier ingår ej.
 - TR** Piller dahil değildir.
 - JP** 電池は含まれていません。
 - CN** 电池不包含在内。
 - TC** 電池不包含在內。
 - KO** 배터리는 포함되지 않습니다.
 - ID** Baterai tidak termasuk.
 - TH** แบตเตอรี่ไม่รวมอยู่ด้วย.
- البطاريات غير مشمولة. **AR**

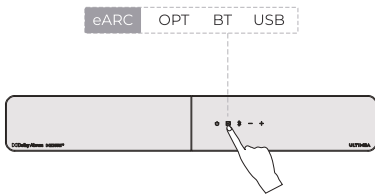
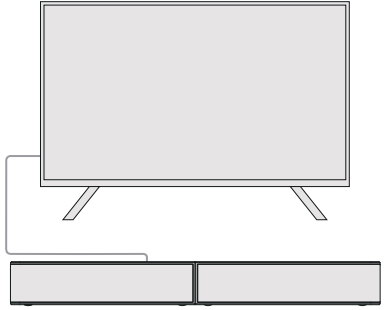
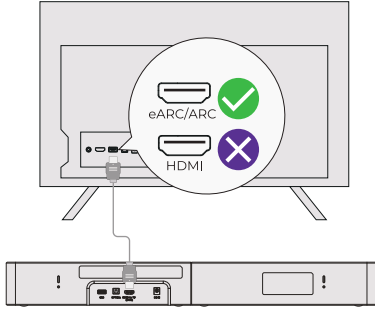

or

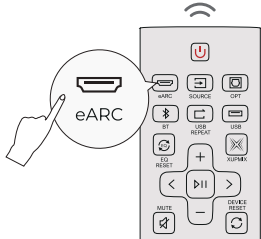

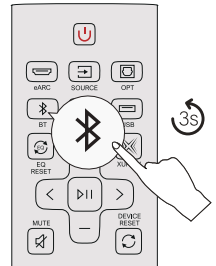
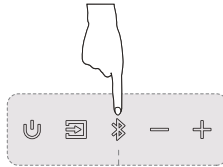
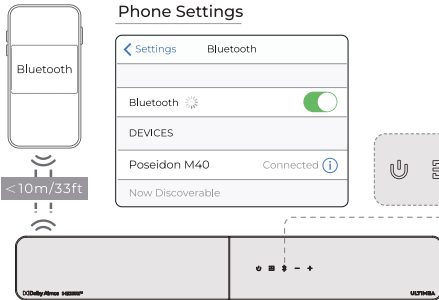
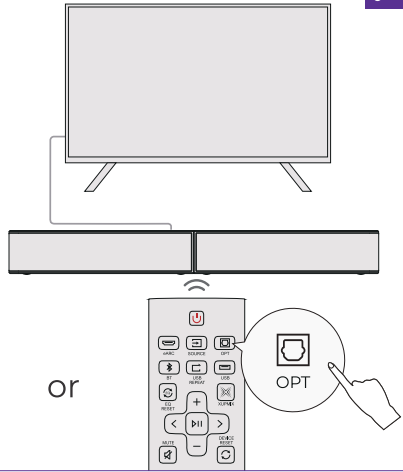
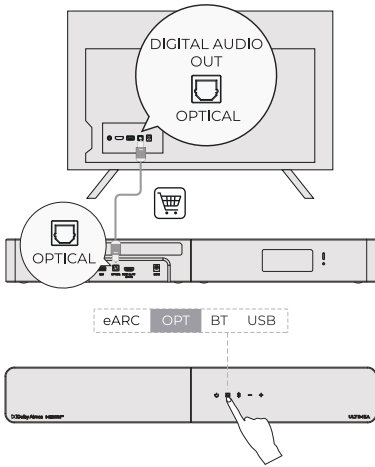

- EN** Short press to select Bluetooth channel, long press to disconnect.
- DE** Kurz drücken, um den Bluetooth-Kanal auszuwählen, lang drücken, um die Verbindung zu trennen.
- FR** Appuyez brièvement pour sélectionner le canal Bluetooth, appuyez longuement pour déconnecter.
- ES** Presione brevemente para seleccionar el canal Bluetooth, presione prolongadamente para desconectar.
- IT** Premere brevemente per selezionare il canale Bluetooth, premere a lungo per disconnettere.
- PT** Pressione rapidamente para selecionar o canal Bluetooth, pressione longamente para desconectar.
- NL/BE** Kort indrukken om het Bluetooth-kanaal te selecteren, lang indrukken om de verbinding te verbreken.
- PL** Krótko naciśnij, aby wybrać kanał Bluetooth, przytrzymaj, aby rozłączyć.
- SV** Tryck kort för att välja Bluetooth-kanal, tryck länge för att koppla bort.
- TR** Kısa basarak Bluetooth kanalını seçin, uzun basarak bağlantıyı kesin.
- JP** 短く押してBluetoothチャンネルを選択し、長押しして切断します。
- CN** 短按选择蓝牙通道，长按断开连接。
- TC** 短按選擇藍牙通道，長按斷開連接。
- KO** 짧게 눌러 블루투스 채널을 선택하고, 길게 눌러 연결을 해제하세요.
- ID** Tekan singkat untuk memilih saluran Bluetooth, tekan lama untuk memutuskan koneksi.
- TH** กดสั้นเพื่อเลือกช่อง Bluetooth กดค้างเพื่อเลิกการเชื่อมต่อ

اضغط ضغطة قصيرة لاختيار قناة البلوتوث، واضغط مغطولاً للقطع. **AR**

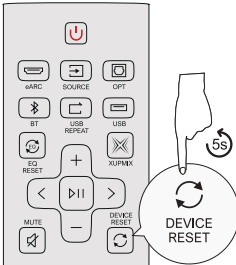
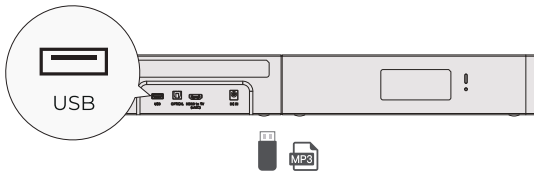

- EN Press and hold for 5 seconds to reset.
- DE Drücken und halten Sie 5 Sekunden lang, um zurückzusetzen.
- FR Appuyez et maintenez pendant 5 secondes pour réinitialiser.
- ES Mantén presionado durante 5 segundos para restablecer.
- IT Tieni premuto per 5 secondi per ripristinare.
- PT Pressione e segure por 5 segundos para redefinir.
- NL/BE Druk 5 seconden lang in om opnieuw in te stellen.
- PL Naciśnij i przytrzymaj przez 5 sekundy, aby zresetować.
- SV Håll ner i 5 sekunder för att återställa.
- TR Sıfırlamak için 5 saniye basılı tutun.
- JP 5秒間押し続けてリセットします。
- CN 按住5秒钟重置。
- TC 按住5秒鐘重設。
- KO 5초 동안 눌러 리셋합니다.
- ID Tekan dan tahan selama 5 detik untuk mengatur ulang.
- TH กดค้างไว้ 5 วินาทีเพื่อรีเซ็ต



AR اضغط مع الاستمرار لمدة 5 ثوان لإعادة تعيين.



<10m/33ft



- EN On your Android™ or iOS device, connect to the soundbar via the Ultimea app.
- DE Verbinden Sie auf Ihrem Android™- oder iOS-Gerät die Soundbar über die Ultimea-App.
- FR Sur votre appareil Android™ ou iOS, connectez-vous à la barre de son via l'application Ultimea.
- ES En su dispositivo Android™ o iOS, conéctese a la barra de sonido a través de la aplicación Ultimea.
- IT Sul tuo dispositivo Android™ o iOS, connettiti alla soundbar tramite l'app Ultimea.
- PT No seu dispositivo Android™ ou iOS, conecte-se à soundbar através do aplicativo Ultimea.
- NL/BE Op uw Android™- of iOS-apparaat verbindt u de soundbar via de Ultimea-app.
- PL Na swoim urządzeniu z systemem Android™ lub iOS połącz się z soundbarem za pomocą aplikacji Ultimea.
- SV Anslut till soundbaren via Ultimea-appen på din Android™- eller iOS-enhet.
- TR Android™ veya iOS cihazınızda, Ultimea uygulaması aracılığıyla soundbara bağlanın.
- JP お使いのAndroid™またはiOSデバイスで、Ultimeaアプリを使用してサウンドバーに接続してください。
- CN 在您的 Android™ 或 iOS 设备上，通过 Ultimea 应用连接到 Soundbar。
- TC 在您的 Android™ 或 iOS 設備上，通過 Ultimea 應用連接到 Soundbar。
- KO Android™ 또는 iOS 기기에서 Ultimea 앱을 통해 사운드바에 연결하세요.
- ID Pada perangkat Android™ atau iOS Anda, hubungkan ke Soundbar melalui aplikasi Ultimea.
- TH บนอุปกรณ์ Android™ หรือ iOS ของคุณ เชื่อมต่อกับ Soundbar ผ่านแอป Ultimea

AR على جهاز Android™ أو iOS الخاص بك، اتصل بمكبر الصوت عبر تطبيق Ultimea.

ULTIMEA

Product Name: Soundbar
Model No.: U3120



Ultimea GmbH
Buchenring 57, 22359 Hamburg, Germany



EVATOST CONSULTING LTD
Office 101 32 Threadneedle Street, London, United Kingdom, EC2R 8AY

@Ultimea Inc. All rights reserved, registered in the United States and other countries.
801 S. Dupont Ave., Ste G, Ontario, CA, 91761, USA

Made in China

Manufacturer: Ultimea Technology (Shenzhen) Limited

Address: 20th Floor, Building 4, Tianan Cloud Park, Bantian St., Longgang District, Shenzhen, China 518000

Manufacturer Contact Information:

+1 888-598-8875 (US)
Mon-Fri 9am-5pm (PST)
+49 89-628-25828 (EU)
Mon-Fri 9am-5pm (CET)

✉ support@ultimea.com

🌐 support.ultimea.com

If you need our support, kindly reach out to our service team.
We are always glad to help.



Download Ultimea App



Search for "ULTIMEA" on social media.



Warranty Extension Plan



RoHS



FR
Cet appareil,
ses accessoires,
et cordons
se recyclent

REPRISE
À LA LIVRAISON



À DÉPOSER
EN MAGASIN



À DÉPOSER
EN DÉCHÈTERIE



Points de collecte sur www.uefairedemesdechets.fr

PROPER DISPOSAL INSTRUCTIONS

This mark shown on the product or its packaging, indicates that this product should not be disposed of with other household waste at the end of its working life. To prevent possible harm to the environment or human health from uncontrolled waste disposal, please separate this from other types of wastes and recycle it responsibly to promote the sustainable reuse of material resources.



Waste Electrical & Electronic Equipment

Household user should contact either the retailer where they purchased this product, or their local government office, for details of where and how they can take this item for environmentally safe recycling. Business users should contact their suppliers and check the terms and conditions of the purchase contract. This product should not be mixed with other commercial wastes for disposal.

WIRELESS FREQUENCY RANGE AND WIRELESS OUTPUT POWER:

Frequency: 2.402GHz-2.48GHz

The Max. transmit power (Applies only to the EU): 10 dBm

FCC REGULATORY COMPLIANCE

Any changes or modifications not expressly approved by the party responsible for compliance could void the user's authority to operate the equipment.

This device complies with Part 15 of the FCC Rules.

Operation is subject to the following two conditions:

- (1) This device may not cause harmful interference.
- (2) This device must accept any interference received, including interference that may cause undesired operation.

NOTE: This equipment has been tested and found to comply with the limits for a Class B digital device, pursuant to part 15 of the FCC Rules. These limits are designed to provide reasonable protection against harmful interference in a residential installation. This equipment generates, uses, and can radiate radio frequency energy, and if not installed and used in accordance with the instructions, may cause harmful interference to radio communications.

However, there is no guarantee that interference will not occur in a particular installation. If this equipment does cause harmful interference to radio or television reception, which can be determined by turning the equipment off and on, the user is encouraged to try to correct the interference by one or more of the following measures:

- Reorient or relocate the receiving antenna.
- Increase the separation between the equipment and the receiver.
- Connect the equipment to an outlet on a circuit different from that to which the receiver is connected.
- Consult the dealer or an experienced radio / TV technician for help.

This equipment complies with FCC radiation exposure limits set forth for an uncontrolled environment. This equipment should be installed and operated with a minimum distance of 20cm between the radiator & your body. This transmitter must not be co-located or operating in conjunction with any other antenna or transmitter.

ISED WARNINGS

This device contains licence-exempt transmitter(s)/receiver(s) that comply with Innovation, Science and Economic Development Canada's licence-exempt RSS(s). Operation is subject to the following two conditions:

- (1) This device may not cause interference.
- (2) This device must accept any interference, including interference that may cause undesired operation of the device.

L'émetteur/récepteur exempt de licence contenu dans le présent appareil est conforme aux CNR d'Innovation, Sciences et Développement économique Canada applicables aux appareils radio exempts de licence. L'exploitation est autorisée aux deux conditions suivantes :

- 1) L'appareil ne doit pas produire de brouillage;
- 2) L'appareil doit accepter tout brouillage radioélectrique subi, même si le brouillage est susceptible d'en compromettre le fonctionnement.
- 3) The device meets the exemption from the routine evaluation limits in issue6 of RSS 102 and compliance with RSS-102 RF exposure, users can obtain Canadian information on RF exposure and compliance.

Le dispositif rencontre l'exemption des limites courantes d'évaluation dans la numéro 6 de RSS 102 et la conformité à l'exposition de RSS-102 rf, utilisateurs peut obtenir l'information canadienne sur l'exposition et la conformité de rf.

This transmitter must not be co-located or operating in conjunction with any other antenna or transmitter. This equipment should be installed and operated with a minimum distance of 20 centimeters between the radiator and your body. Cet émetteur ne doit pas être Co-placé ou ne fonctionner en même temps qu'aucune autre antenne ou émetteur. Cet équipement devrait être installé et actionné avec une distance minimum de 20 centimètres entre le radiateur et votre corps.

Wireless Capability Description:

The right rear surround is equipped with a wireless signal reception module, enabling it to receive audio signals from the main device for playback. This device only supports wireless signal reception and cannot relay or forward signals. The subwoofer in the system is designed for wired connection and does not have the ability to transmit or receive wireless signals.

The remote control uses infrared (IR) technology for device control and does not support any other wireless signal transmission or reception capabilities.

CA WARNING: Can expose you to BPA, a carcinogen, and BPA, a reproductive, toxicant. See www.P65Warnings.ca.gov.

CE WARNINGS

- 1) Do not install this equipment in a confined or building-in space such as a book case or similar unit, and remain a well ventilation conditions. The ventilation should not be impeded by covering the ventilation openings with items such as newspaper, table-cloths, curtains etc.
- 2) WARNING: To reduce the risk of fire or electric shock, do not expose this apparatus to rain or moisture. The apparatus shall not be exposed to dripping or splashing and that objects filled with liquids, such as vases, shall not be placed on apparatus.
- 3) WARNING: The adapter plug is used as disconnect device, the disconnect device shall remain readily operable.
- 4) Frequency: 2.402GHz-2.48GHz
- 5) The Max. transmit power: 10 dBm

EU Declaration of Conformity

We (Manufacturer is responsible for this declaration)
Ultimea Technology (Shenzhen) Limited
(Company name)

20th Floor, Building 4, Tianan Cloud Park, Bantian St.,
Longgang District Shenzhen, China 518000
(Company address)

Declare under our sole responsibility that the product
Trade Mark: ULTIMEA
Product Name: Soundbar
Model No.: U3120

The product to which this declaration relates is in conformity with the essential requirements set out in the Council Directive on the Approximation of the laws of the Member States relating to the Radio Equipment Directive (2014/53/EU), the Restriction of Hazardous Substances Directive (2011/65/EU), the Electromagnetic Compatibility Directive (2014/30/EU), and the Low Voltage Directive (2014/35/EU). The product is responsible for affixing the CE marking, and the following standards were applied:

EN 55032:2015/A1:2020
EN 55035:2017/A11:2020
EN IEC 61000-3-2:2019/A1:2021
EN 61000-3-3:2013/A2:2021
ETSI EN 301 489-1 V2.2.3 (2019-11)
ETSI EN 301 489-17 V3.2.4 (2024-09)
ETSI EN 300 328 V2.2.2 (2019-07)
EN 50663: 2017
EN IEC 62368-1:2020+A11:2020
IEC 62321-3-1:2013
IEC 62321-4:2013+A1:2017
IEC 62321-5:2013
IEC 62321-6:2015
IEC 62321-7-1:2015
IEC 62321-7-2:2017
IEC 62321-8:2017

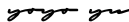
Full Name: Yoyo.Yu
Position: Approbation Manager
Signature: 

Place/Date: Shenzhen, China / Feb. 01-2026

Trade Marks:



Dolby, Dolby Atmos, and the double-D symbol are registered trademarks of Dolby Laboratories Licensing Corporation. Manufactured under license from Dolby Laboratories. Confidential unpublished works. Copyright © 2012–2024 Dolby Laboratories. All rights reserved.



The Bluetooth® word mark and logos are registered trademarks owned by Bluetooth SIG, Inc. and any use of such marks by Ultimea Technology (Shenzhen) Limited. is under license. Other trademarks and trade names are those of their respective owners.

HIGH-DEFINITION MULTIMEDIA INTERFACE

The terms HDMI, HDMI High-Definition Multimedia Interface, HDMI trade dress and the HDMI Logos are trademarks or registered trademarks of HDMI Licensing Administrator, Inc.



- EN** Normally, the Soundbar and Subwoofer are pre-paired. If disconnected, follow the steps below. The subwoofer indicator will stay solid when paired successfully.
- DE** Normalerweise sind die Soundbar und der Subwoofer vorab gekoppelt. Bei einer Trennung folgen Sie den untenstehenden Anweisungen. Die Subwoofer-Anzeige leuchtet konstant, wenn die Verbindung erfolgreich ist.
- FR** Normalement, la barre de son et le caisson de basses sont déjà appairés. En cas de déconnexion, suivez les instructions ci-dessous. Le voyant du caisson restera fixe une fois l'appairage réussi.
- ES** Normalmente, la barra de sonido y el subwoofer están emparejados previamente. Si se desconectan, siga los pasos a continuación. El indicador del subwoofer permanecerá encendido cuando se haya emparejado con éxito.
- IT** Normalmente, la soundbar e il subwoofer sono pre-accoppiati. In caso di disconnessione, seguire i passaggi seguenti. L'indicatore del subwoofer rimarrà acceso una volta completato l'abbinamento.
- PT** Normalmente, a barra de som e o subwoofer são pré-emparelhados. Caso esteja desligado, siga os passos abaixo. O indicador do subwoofer permanecerá sólido quando o emparelhamento for bem-sucedido.
- NL/BE** Normaal gesproken zijn de soundbar en subwoofer vooraf gekoppeld. Indien losgekoppeld, volg de onderstaande stappen. Het lampje op de subwoofer blijft branden wanneer het succesvol is gekoppeld.
- PL** Zazwyczaj soundbar i subwoofer są wstępnie sparowane. W przypadku rozłączenia, wykonaj poniższe kroki. Wskaźnik na subwooferze będzie stale świecić po udanym sparowaniu.
- SV** Vanligtvis är soundbaren och subwoofern förkopplade. Om de kopplas bort, följ stegen nedan. Subwooferns indikatorlampa kommer att lysa fast när den har anslutits framgångsrikt.
- TR** Normalde, Soundbar ve Subwoofer önceden eşleştirilmiştir. Ayrılma durumunda aşağıdaki adımları izleyin. Subwoofer'in göstergesi eşleştirme başarılı olduğunda sabit yanar.
- JP** 通常、サウンドバーとサブウーファーは事前にペアリングされています。切断された場合、以下の手順に従ってください。サブウーファーのインジケーターが点灯するとペアリングが成功です。
- CN** 通常情况下，Soundbar 和低音炮是预先配对的。如果断开连接，请按照以下步骤操作。配对成功后，低音炮指示灯将保持常亮。
- TC** 通常情況下，Soundbar 和 Subwoofer 是預先配對的。如果斷開連接，請依照下列步驟操作。配對成功後，重低音指示燈將保持常亮。
- KO** 일반적으로 사운드바와 서브우퍼는 사전 페어링되어 있습니다. 연결이 끊어진 경우 아래 단계를 따르세요. 성공적으로 페어링되면 서브우퍼 표시등이 계속 켜져 있습니다.
- ID** Biasanya, Soundbar dan Subwoofer sudah dipasangkan sebelumnya. Jika terputus, ikuti langkah-langkah di bawah ini. Indikator subwoofer akan tetap menyala saat berhasil dipasangkan.
- TH** ปกติแล้วซาวด์บาร์และซับวูฟเฟอร์จะจับคู่ไว้ล่วงหน้า หากหลุดการเชื่อมต่อ ให้ทำตามขั้นตอนด้านล่างนี้ ไฟแสดงสถานะของซับวูฟเฟอร์จะคงสว่างเมื่อจับคู่สำเร็จ

AR بشكل افتراضي، يتم اقتران مكبر الصوت ومضخم الصوت مسبقاً. في حالة قطع الاتصال، اتبع التعليمات التالية: سيظل ضوء المؤشر على مضخم الصوت ثابتاً عند اكتمال الاقتران بنجاح.

